

Trihedral Corner Reflector

57 mm length

DESCRIPTION

Anteral's triangular trihedral reflectors (TTCRs) are used for simulating radar target precisely and radar system calibration. The TTCR-57 is a 57-mm length trihedral reflector fabricated in aluminum with a gold chemical film finish. The TTCR can be easily mounted onto a tripod for rapid system setup thanks to the mounting bracket with four M3 threaded holes but any custom holes can be added.

APPLICATIONS

Anteral's triangular trihedral reflectors (TTCRs) are used for simulating radar target precisely and radar system calibration and radar system calibration.

RADAR CROSS SECTION AND RELATIVE MAGNITUDE

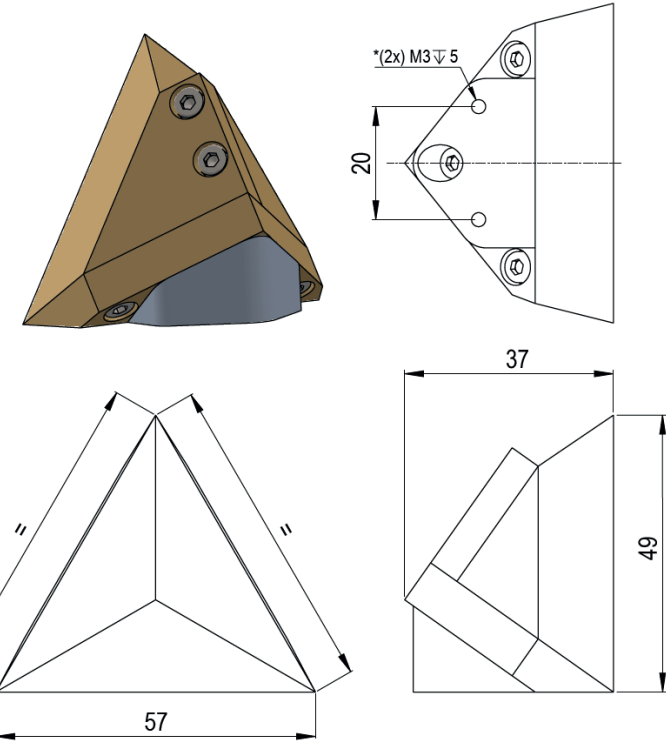
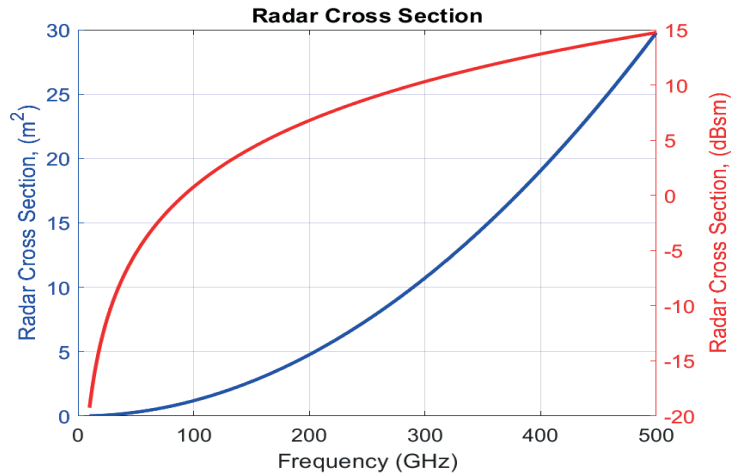

MECHANICAL OUTLINE

Edge length	57 mm
Size	57 x 49 x 37 mm
Weight	56 g
Material	Aluminum
Finish	Gold chemical film
Mounting	2 x M3 clamping holes*

* The base is drilled with 2 through holes but any custom holes can be added.

Additional notes

All data are simulated. Actual values could vary slightly.
Last version: 10/06/2024

