

LB-OH-320-10-C-SF Octave Horn Antenna 2-4 GHz 10dB Gain SMA Female



Octave Horn Antenna Operating From 2GHz to 4GHz With a Nominal 10dB Gain With SMA Female Connector

### Product Information

SKU	LB-OH-320-10-C-SF
-----	-------------------

### Description

Octave horn antenna LB-OH-320-10-C-SF, operating from 2 to 4GHz with a nominal 10dB gain and low VSWR 1.5:1 with SMA Female output connector. The model LB-OH-320-10-C-SF has uniform gain through its frequency span, providing efficient performance characteristics and directionality. It can handle 50W continuously and 3000W peak power. Constructed of lightweight corrosion-resistant aluminum, the antenna will provide years of trouble-free indoor and outdoor service. This octave horn antenna is linearly polarized and ideally suited for EMI testing, direction finding, surveillance, antenna gain and pattern measurements and other applications.

### Technical Specification

Electrical Specification		Interface	
Frequency, Min (GHz)	2	Output Type	Coaxial
Frequency, Max (GHz)	4	Connector	SMA
Gain, Typ (dBi)	10	Connector Gender	Female
Polarization	Linear	Mechanical Specification	
3dB Beamwidth, E-Plane, Min (Deg.)	29	Body Material	Al
3dB Beamwidth, E-Plane, Max (Deg.)	75	Finish	Chemical Conversion Coating, Gray Paint
3dB Beamwidth, H-Plane, Min (Deg.)	29	Size, W (mm)	165
3dB Beamwidth, H-Plane, Max (Deg.)	68	Size, H (mm)	125
Cross Pol. Isolation, Typ (dB)	40	Size, L (mm)	257
VSWR, Typ	1.5:1	Weight, (kg)	1.2
Impedance, (Ohm)	50		
Power Handling, CW, (W)	50		
Power Handling, Peak, (W)	3000		

## Additional Information

Application	General Purpose Indoor & Outdoor, Fixed	Solution for	Gain Reference Antenna Measurement Far-field Measurement System Intergration
-------------	---	--------------	---

## Outline Drawing

SMA-Female Output (P/N: LB-OH-320-10-C-SF)

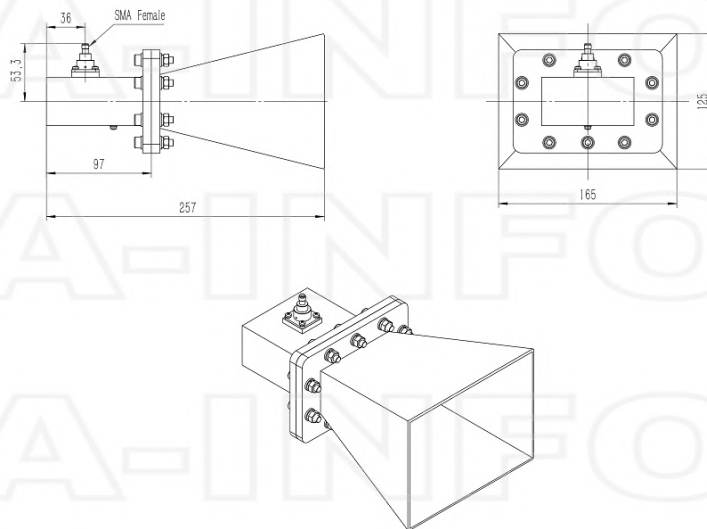

## Typical Test Results

Gain

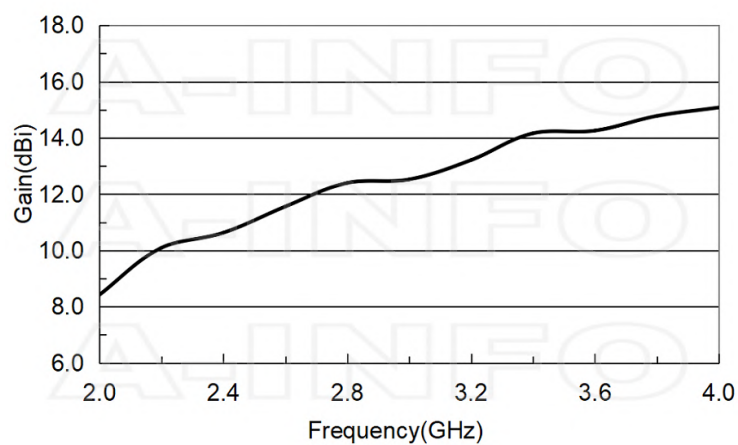

## Antenna Factor

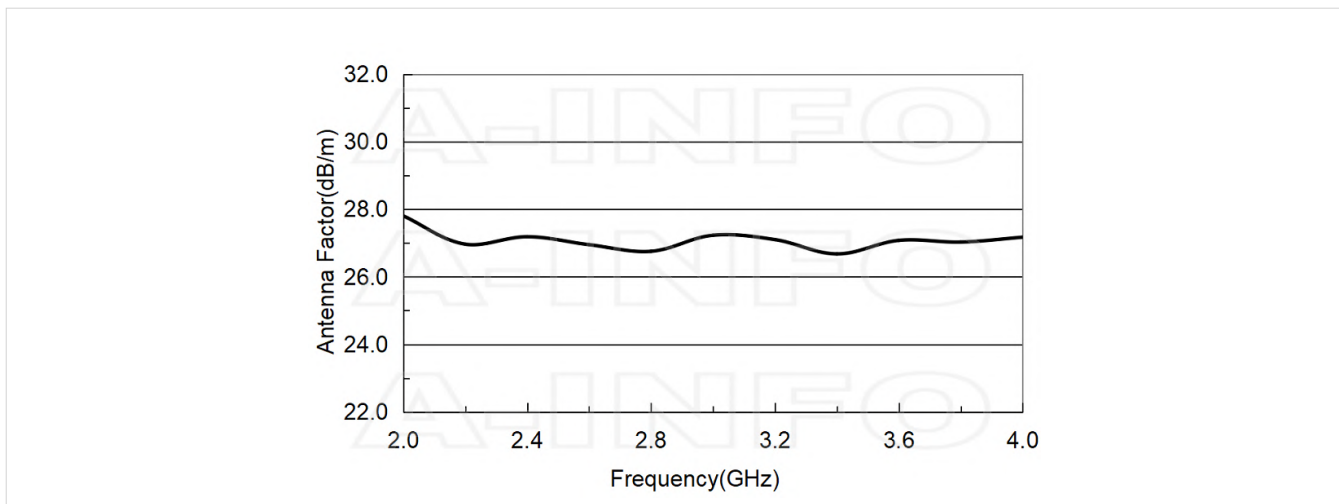

## Antenna Factor (Table)

Frequency(GHz)	Gain(dBi)	AF(dB/m)
2.0	8.4	27.8
2.2	10.1	27.0
2.4	10.6	27.2
2.6	11.6	27.0
2.8	12.4	26.8
3.0	12.5	27.2
3.2	13.2	27.1
3.4	14.2	26.7
3.6	14.3	27.1
3.8	14.8	27.0
4.0	15.1	27.2

## Cross Polarization Isolation

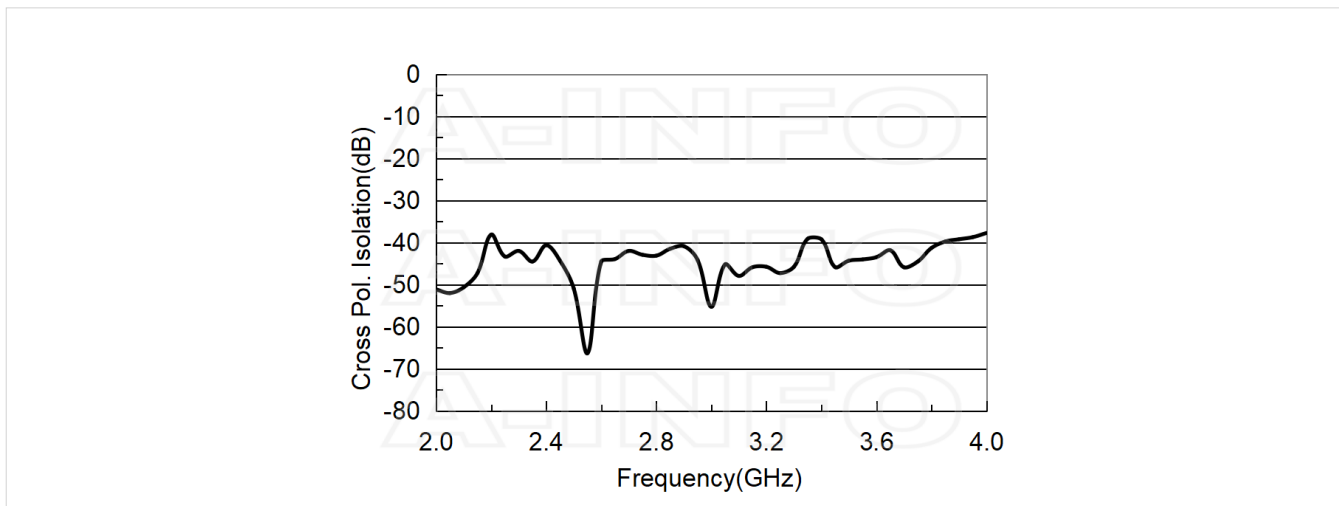

## VSWR

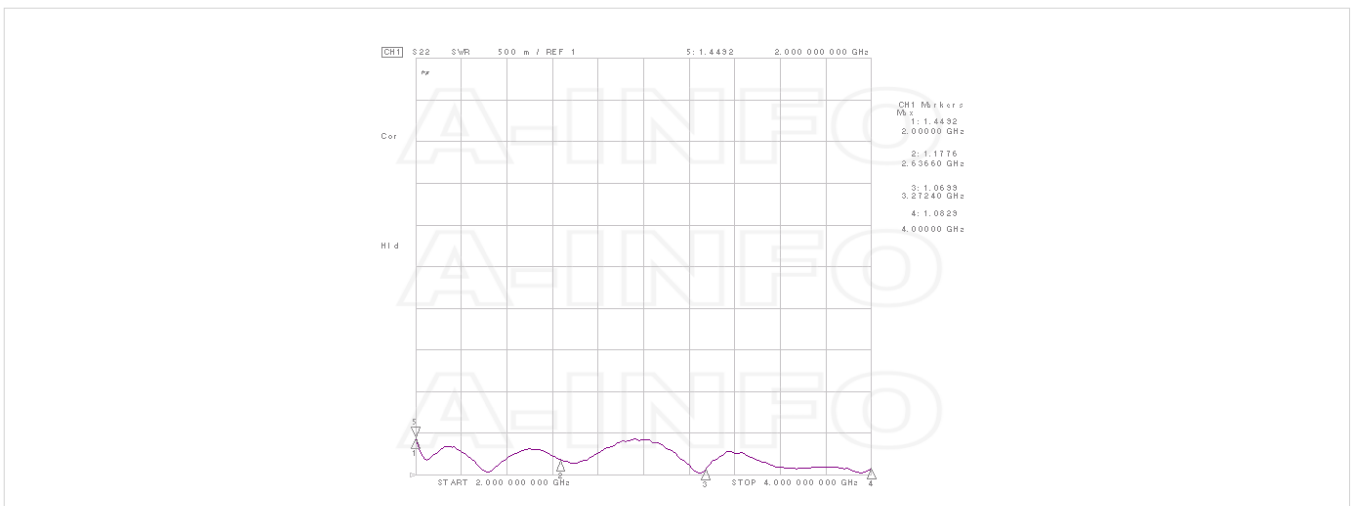

## Beamwidth

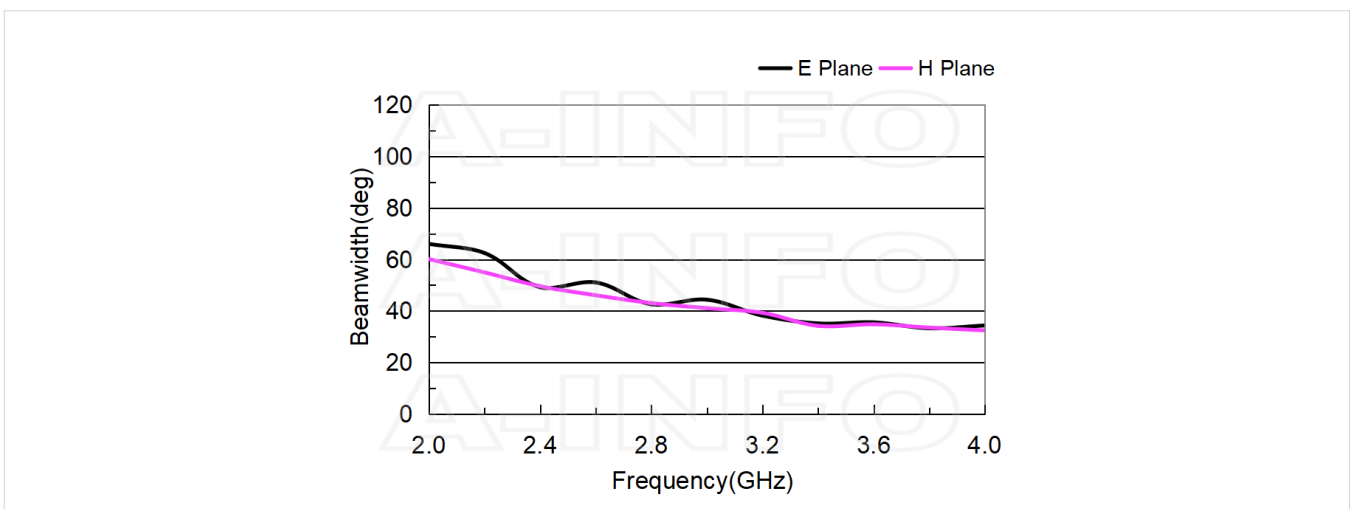

## Pattern

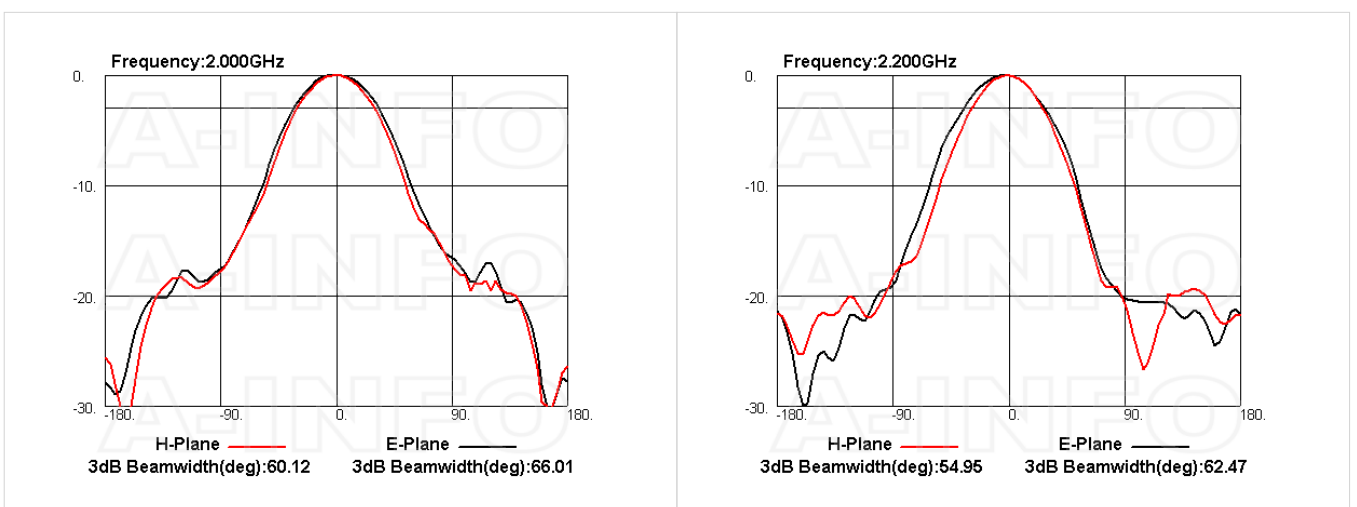

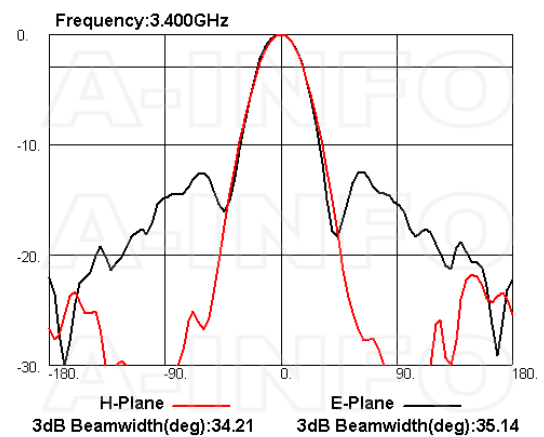
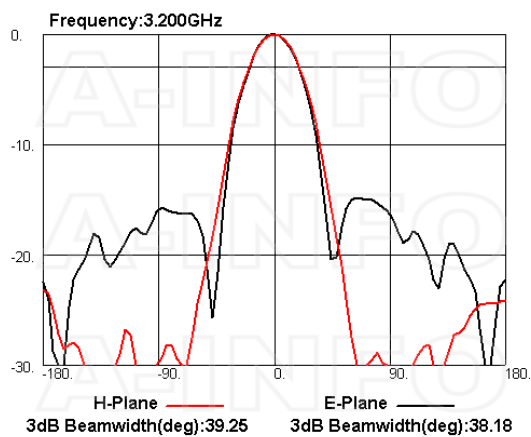
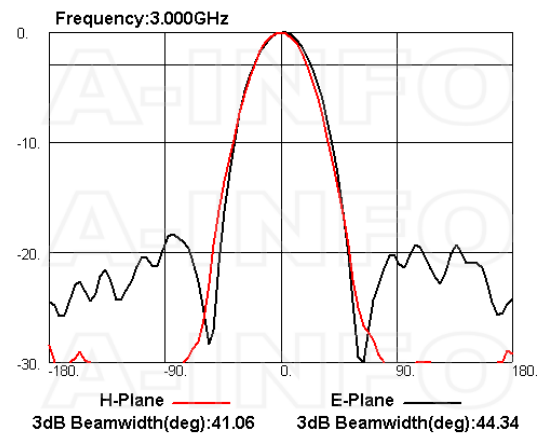
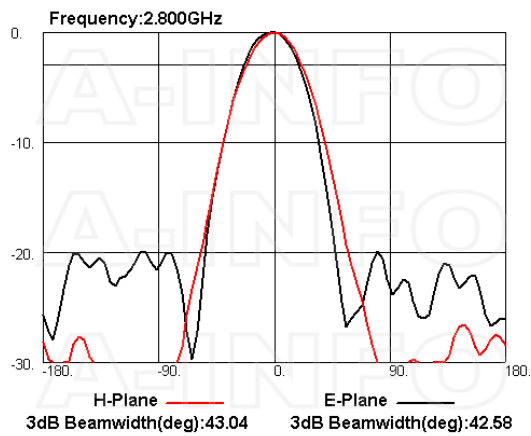
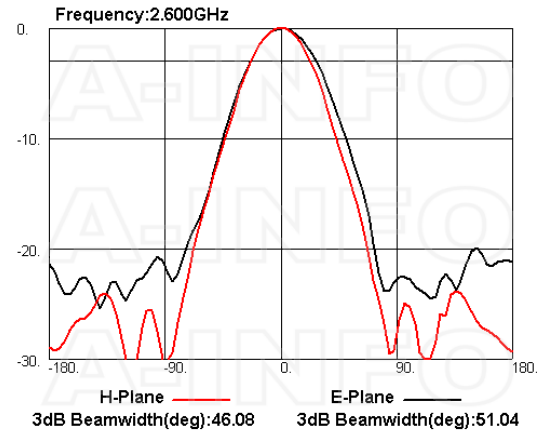
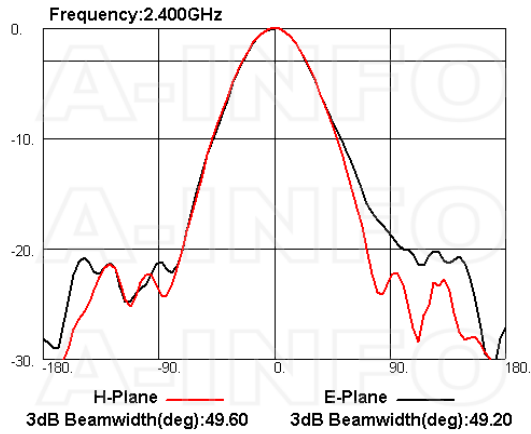

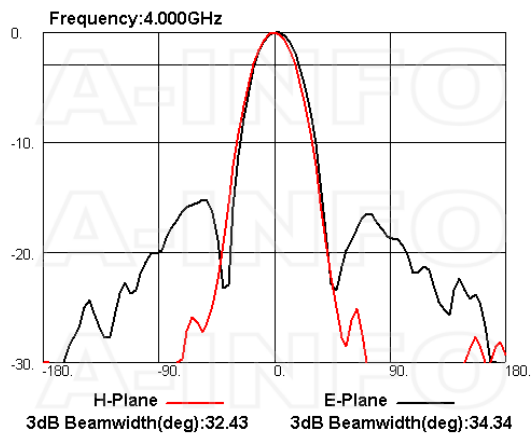
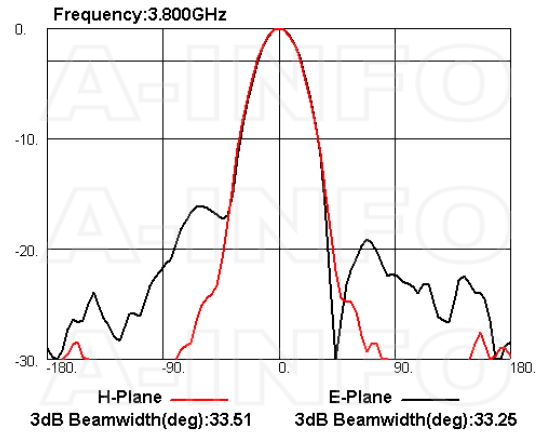
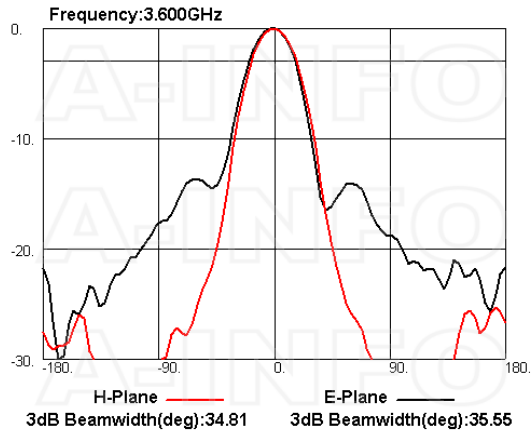

### Related Products



LB-340-10-C-MB Round Type Mounting Bracket



LB-340-10-C-L L type mounting bracket



LB-340-10-C-MA Stinger Type Mounting Bracket



SM-SM-A050-1000 Flexible Cable Assembly 1000mm DC- 26.5GHz SMA Male to SMA Male



SM-SM-A050-1500 Flexible Cable Assembly 1500mm DC- 26.5GHz SMA Male to SMA Male



SM-SM-A050-2000 Flexible Cable Assembly 2000mm DC- 26.5GHz SMA Male to SMA Male



SM-SM-A050-3000 Flexible Cable Assembly 3000mm DC- 26.5GHz SMA Male to SMA Male



SM-SM-A050-5000 Flexible Cable Assembly 5000mm DC- 26.5GHz SMA Male to SMA Male



SM-SM-A050-10000 Flexible Cable Assembly 10000mm DC- 26.5GHz SMA Male to SMA Male



SM-SM-A080-200 Flexible Cable Assembly 200mm DC- 26.5GHz SMA Male to SMA Male



SM-SM-A080-300 Flexible Cable Assembly 300mm DC- 26.5GHz SMA Male to SMA Male



SM-SM-A080-500 Flexible Cable Assembly 500mm DC- 26.5GHz SMA Male to SMA Male



SM-SM-A080-1000 Flexible Cable Assembly 1000mm DC- 26.5GHz SMA Male to SMA Male



SM-SM-A080-1500 Flexible Cable Assembly 1500mm DC- 26.5GHz SMA Male to SMA Male



SM-SM-A080-2000 Flexible Cable Assembly 2000mm DC- 26.5GHz SMA Male to SMA Male



SM-SM-A080-3000 Flexible Cable Assembly 3000mm DC- 26.5GHz SMA Male to SMA Male



SM-SM-A080-5000 Flexible Cable Assembly 5000mm DC- 26.5GHz SMA Male to SMA Male



SM-SM-A080-10000 Flexible Cable Assembly 10000mm DC- 26.5GHz SMA Male to SMA Male



SM-SM-A080-20000 Flexible Cable Assembly 20000mm DC- 26.5GHz SMA Male to SMA Male



SM-SM-A100-100 Flexible Cable Assembly 100mm DC- 18GHz SMA Male to SMA Male



SM-SM-A100-200 Flexible Cable Assembly 200mm DC- 18GHz SMA Male to SMA Male



SM-SM-A100-300 Flexible Cable Assembly 300mm DC- 18GHz SMA Male to SMA Male



SM-SM-A100-500 Flexible Cable Assembly 500mm DC- 18GHz SMA Male to SMA Male



SM-SM-A100-1000 Flexible Cable Assembly 1000mm DC- 18GHz SMA Male to SMA Male



SM-SM-A100-1500 Flexible Cable Assembly 1500mm DC- 18GHz SMA Male to SMA Male



SM-SM-A100-2000 Flexible Cable Assembly 2000mm DC- 18GHz SMA Male to SMA Male



SM-SM-A100-3000 Flexible Cable Assembly 3000mm DC- 18GHz SMA Male to SMA Male



SM-SM-A100-5000 Flexible Cable Assembly 5000mm DC- 18GHz SMA Male to SMA Male



SM-SM-A100-10000 Flexible Cable Assembly 10000mm DC- 18GHz SMA Male to SMA Male

### Similar Products



LB-OH-320-10-C-NF Octave Horn Antenna 2-4GHz 10dB Gain N Type Female

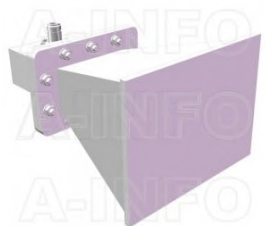

LB-OH-320-10-C-NFSPO Octave Horn Antenna 2-4GHz 10dB Gain N Type Female



LB-OH-320-10-C-SFSPO Octave Horn Antenna 2-4GHz 10dB Gain SMA Female

## About this Datasheet

<ul style="list-style-type: none"><li>● <b>Product Information</b></li></ul> <p>Product Link: <a href="https://www.ainfoinc.com/lb-oh-320-10-c-sf-octave-horn-antenna-2-4-ghz-10db-gain-sma-female">https://www.ainfoinc.com/lb-oh-320-10-c-sf-octave-horn-antenna-2-4-ghz-10db-gain-sma-female</a> Data subject to change without notice. © A-INFO INC. 2024. All Rights Reserved</p>	<ul style="list-style-type: none"><li>● <b>Contact Us</b></li></ul> <p>Address: 60 Tesla, Irvine, CA 92618, USA</p> <p>Website: <a href="http://www.ainfoinc.com">www.ainfoinc.com</a></p> <p>Email: <a href="mailto:sales@ainfoinc.com">sales@ainfoinc.com</a></p>	<ul style="list-style-type: none"><li>● <b>Phone &amp; Fax</b></li></ul> <p>Phone: +1-949-639-9688 +1-949-639-9608</p> <p>Fax: +1-949-639-9670</p>
--	---	--