

### LB-OH-159-20-C-7SPO Octave Horn Antenna 4-8GHz 20dB Gain 7mm



Octave Horn Antenna Operating From 4GHz to 8GHz With a Nominal 20dB Gain With 7mm Connector

## Product Information

SKU	LB-OH-159-20-C-7SPO
-----	---------------------

## Description

Octave horn antenna LB-OH-159-20-C-7SPO, operating from 4 to 8GHz with a nominal 20dB gain and low VSWR 1.5:1 with 7mm output connector. The model LB-OH-159-20-C-7SPO has uniform gain through its frequency span, providing efficient performance characteristics and directionality. It can handle 150W continuously and 3000W peak power. Constructed of lightweight corrosion-resistant aluminum, the horn comes with a specially designed weatherproof radome which provides excellent protection against the rain and dust but has very little loss across the full operating frequency band. This octave horn antenna is linearly polarized and ideally suited for EMI testing, direction finding, surveillance, antenna gain and pattern measurements and other applications.

## Technical Specification

Electrical Specification		Interface	
Frequency, Min (GHz)	4	Output Type	Coaxial
Frequency, Max (GHz)	8	Connector	7mm
Gain, Typ (dBi)	20	Connector Gender	N/A
Polarization	Linear	Mechanical Specification	
3dB Beamwidth, E-Plane, Min (Deg.)	12	Body Material	Al
3dB Beamwidth, E-Plane, Max (Deg.)	21	Finish	Chemical Conversion Coating, Gray Paint
3dB Beamwidth, H-Plane, Min (Deg.)	15	Size, W (mm)	232
3dB Beamwidth, H-Plane, Max (Deg.)	22	Size, H (mm)	180
Cross Pol. Isolation, Typ (dB)	35	Size, L (mm)	318
VSWR, Typ	1.5:1	Weight, (kg)	1.5
Impedance, (Ohm)	50		
Power Handling, CW, (W)	150		
Power Handling, Peak, (W)	3000		

## Additional Information

Application	Outdoor, Waterproof and Dustproof, Fixed	Solution for	Gain Reference Antenna Measurement Far-field Measurement System Intergration
-------------	--	--------------	---

## Outline Drawing

7mm Output with Radome (Option, P/N: LB-OH-159-20-C-7SPO, Outdoor Application)

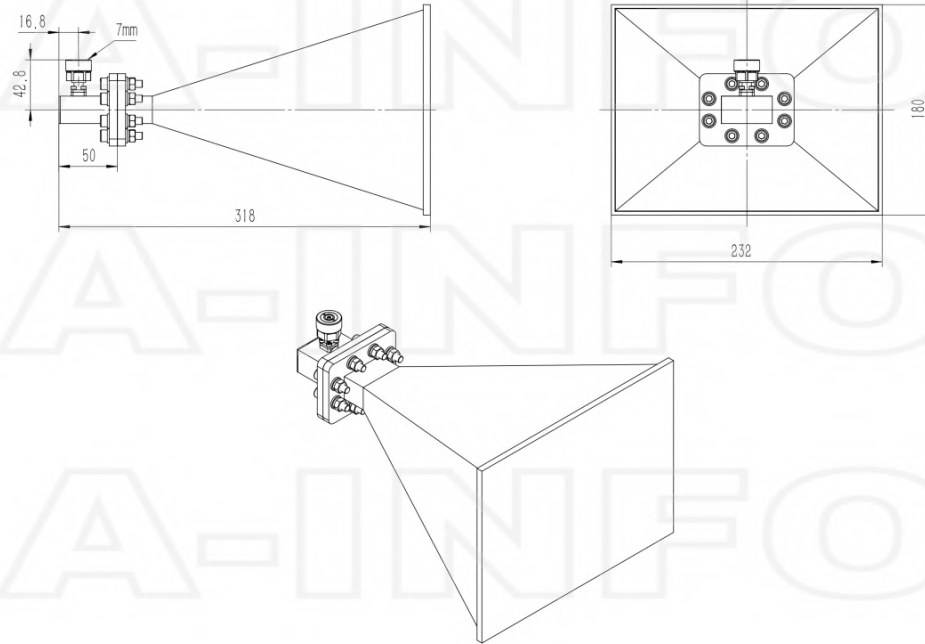

7mm Output with Round Mounting Bracket & Radome (Option, P/N: LB-159-10-C-MB & LB-OH-159-20-C-7SPO, Outdoor Application)

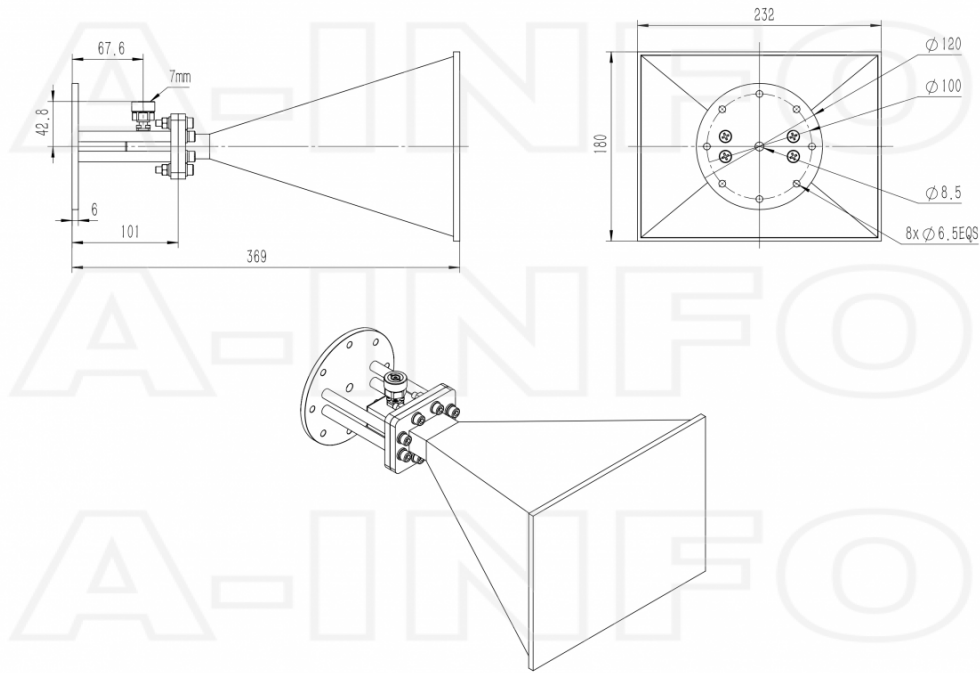

7mm Output with L Type Mounting Bracket & Radome (Option, P/N: LB-159-10-C-MBL & LB-OH-159-20-C-7SPO, Outdoor Application)

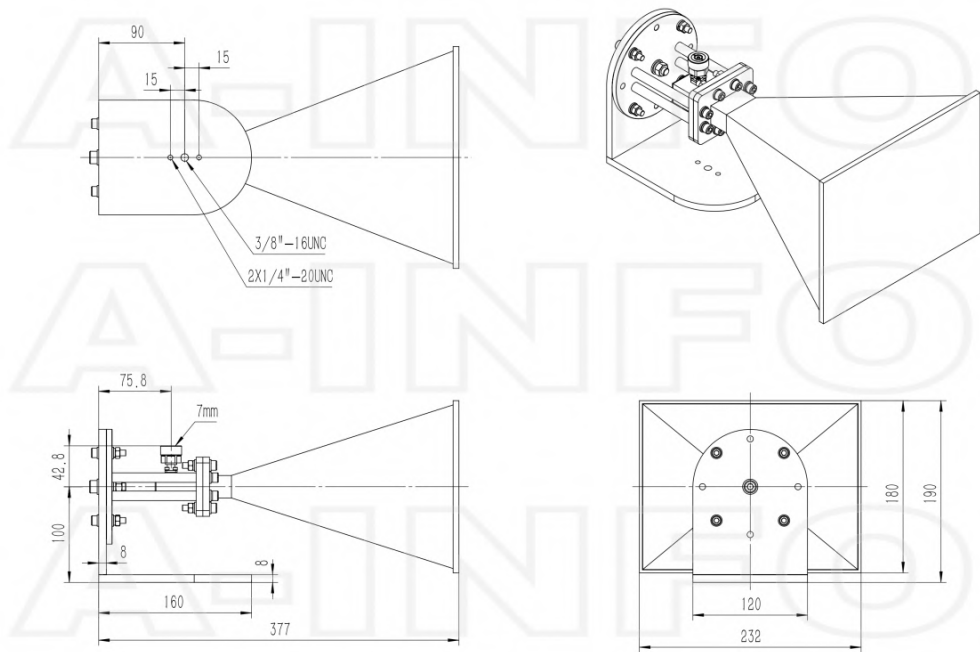

## Typical Test Results

### Gain

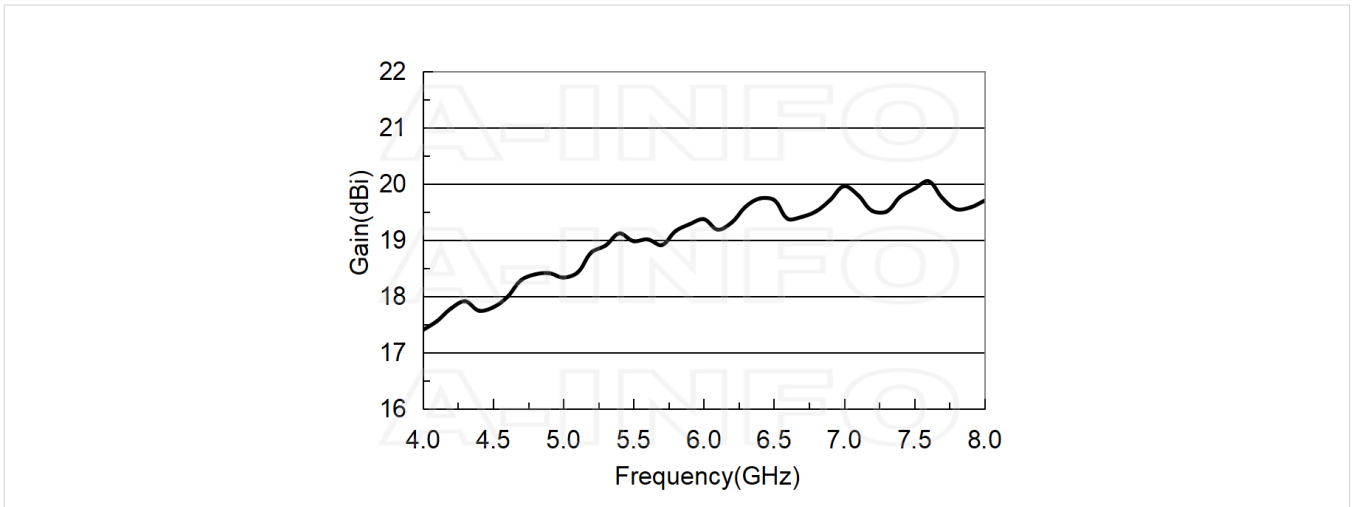

### Antenna Factor

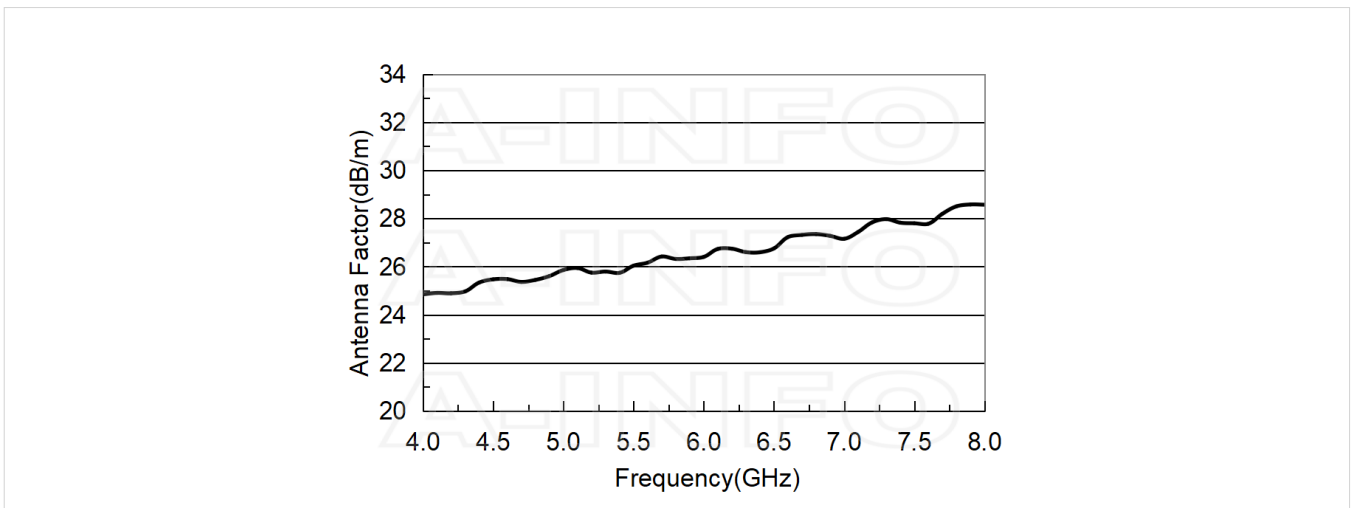

### Antenna Factor (Table)

Frequency(GHz)	Gain(dBi)	AF(dB/m)
4	17.40	24.85
4.25	17.82	24.96
4.5	17.80	25.47
4.75	18.34	25.40
5	18.33	25.86
5.25	18.82	25.79
5.5	18.98	26.04
5.75	19.10	26.31
6	19.37	26.40
6.25	19.54	26.59
6.5	19.71	26.76
6.75	19.47	27.32
7	19.96	27.16
7.25	19.39	28.03
7.5	19.91	27.80
7.75	19.48	28.52
8	19.70	28.57

### Cross Polarization Isolation

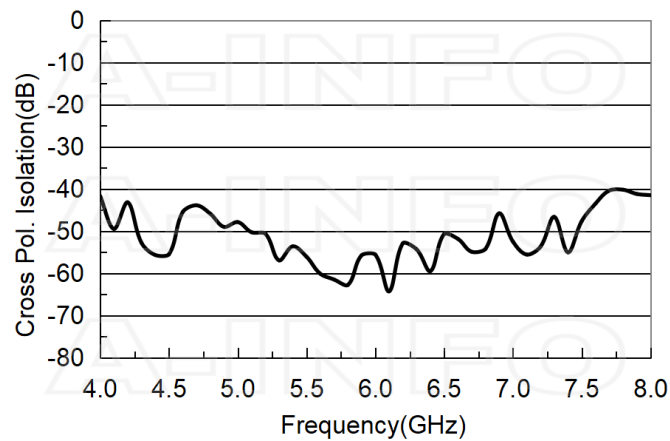

## VSWR

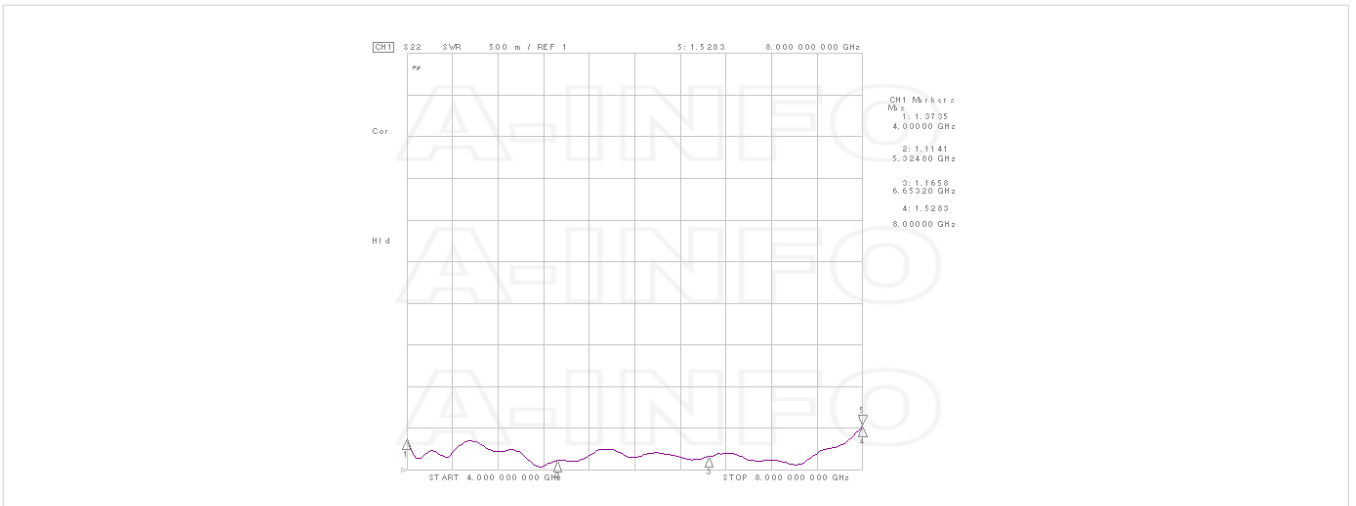

## Beamwidth

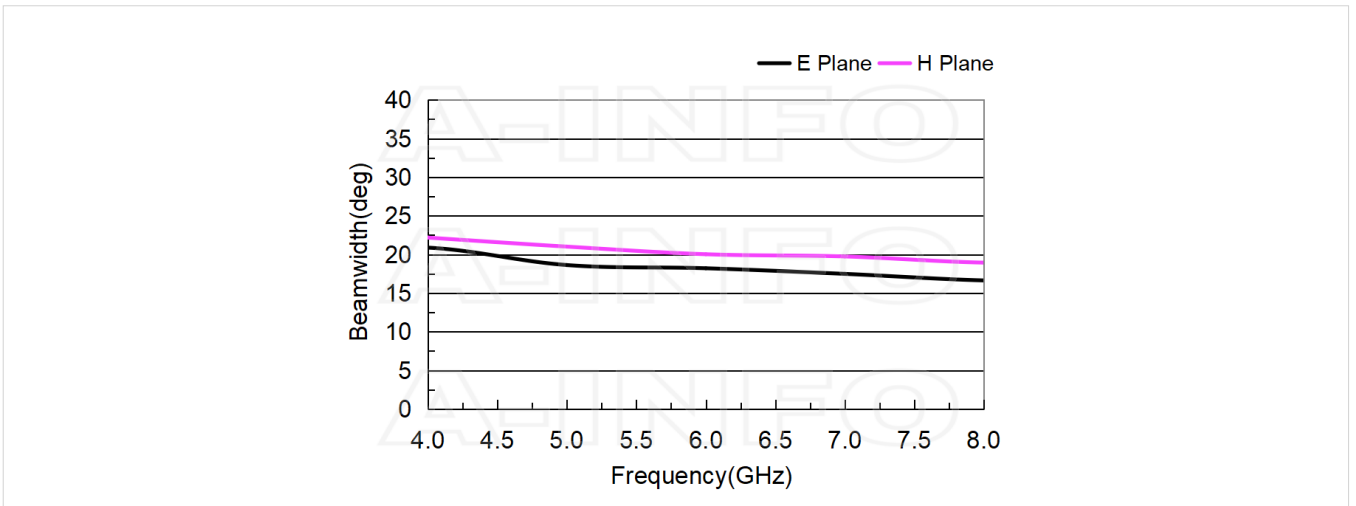

## Pattern

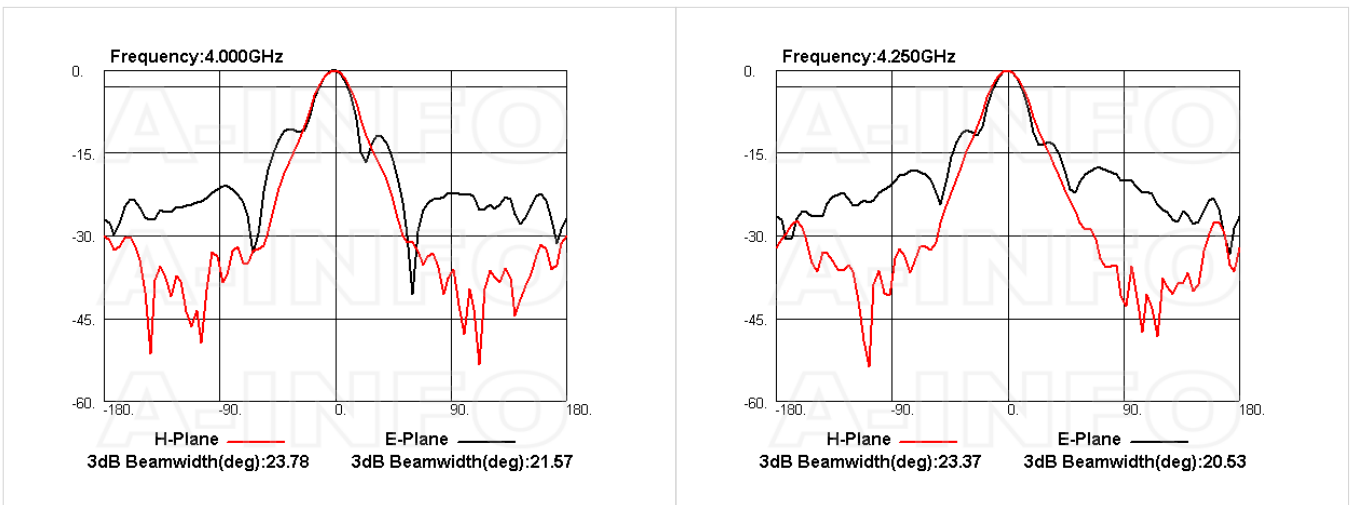

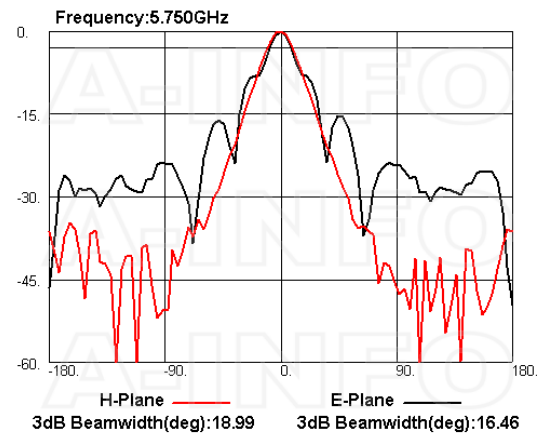
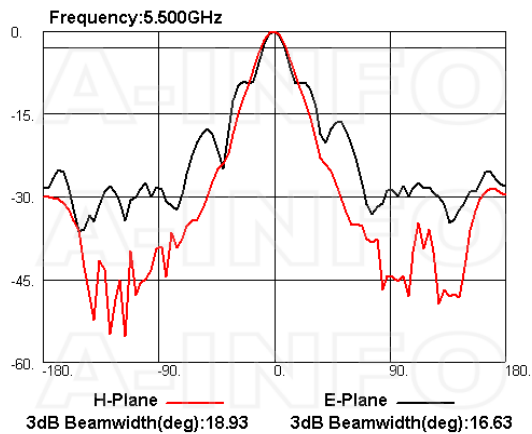
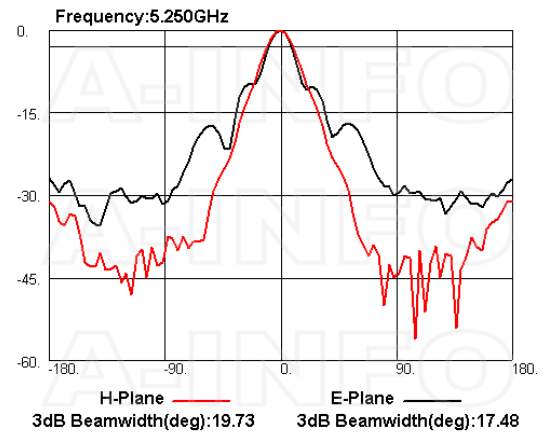
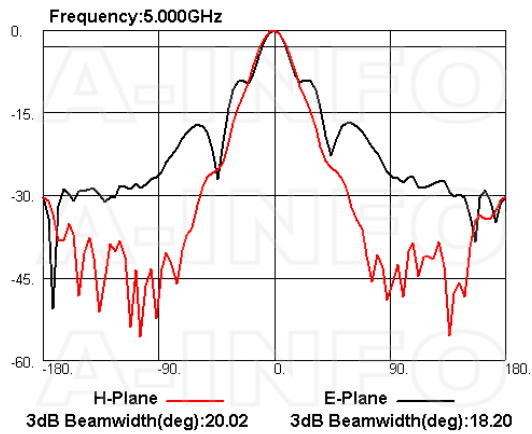
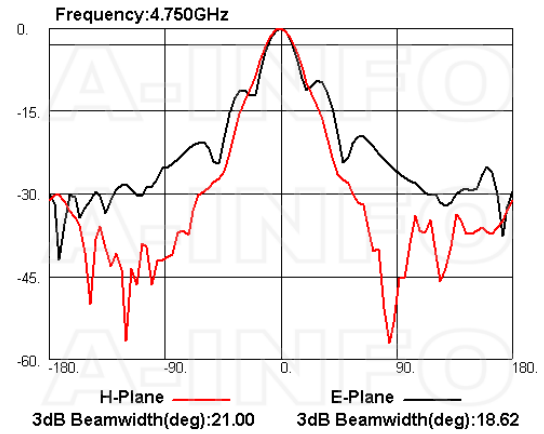
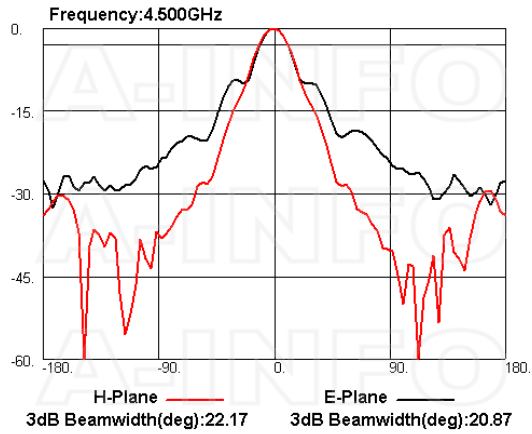

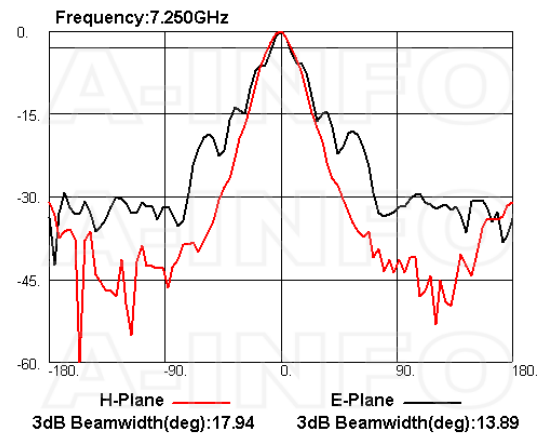
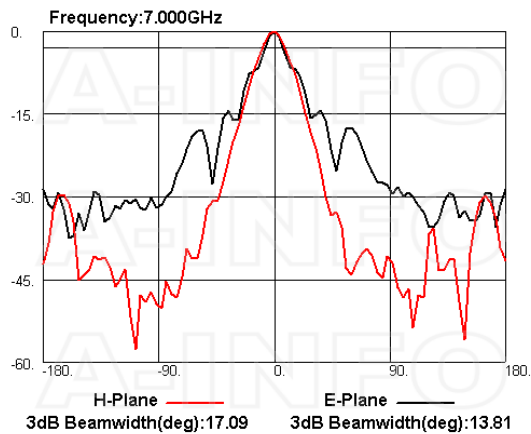
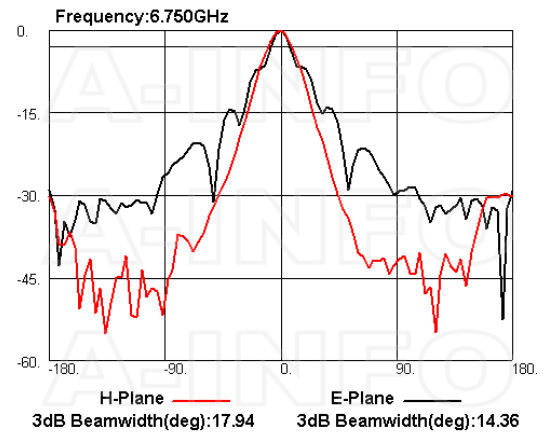
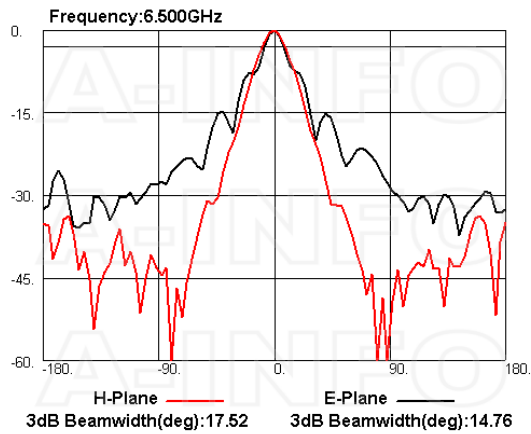
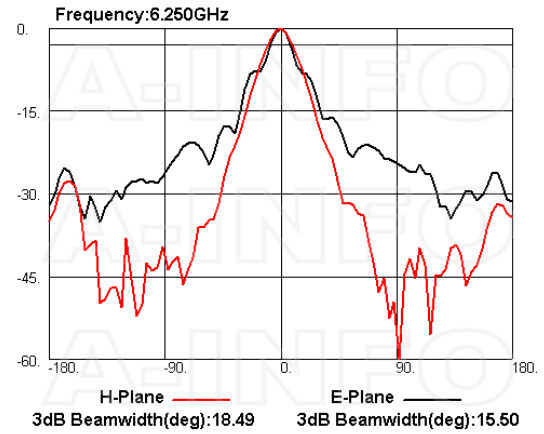
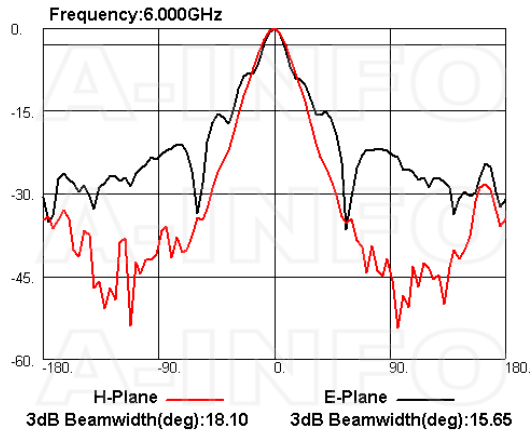

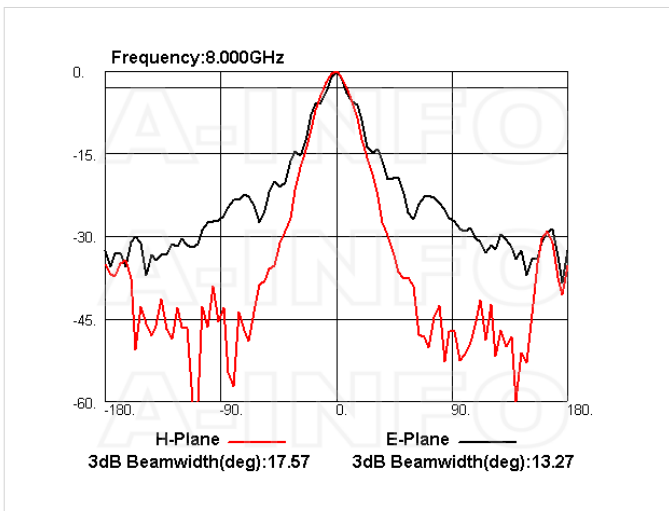
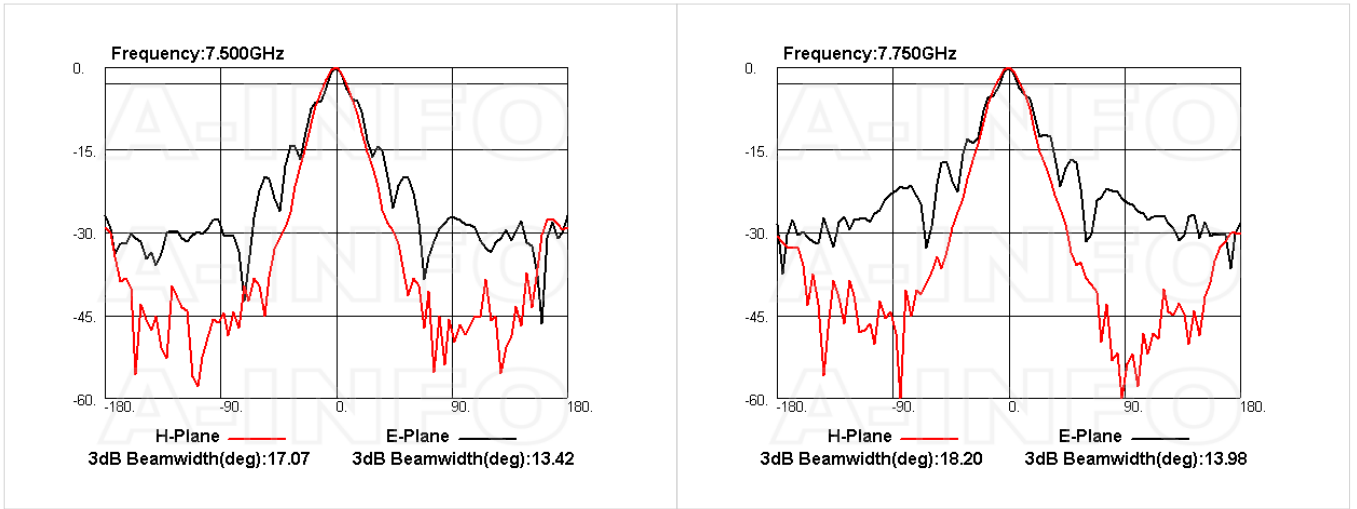

## Related Products



LB-159-10-C-MB Round Type Mounting Bracket



LB-159-10-C-MBL L type mounting bracket



Tripod\_50Kg Al Alloy Tripod



Carrying Case\_LB-159-20-C Al Alloy Carrying Case

### Similar Products

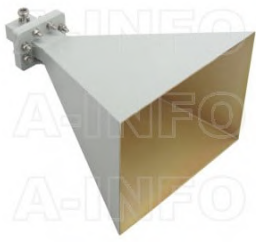

LB-OH-159-20-C-NF Octave Horn Antenna 4-8GHz 20dB Gain N Type Female



LB-OH-159-20-C-NFSPO Octave Horn Antenna 4-8GHz 20dB Gain N Type Female

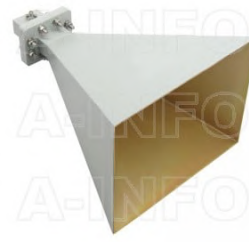

LB-OH-159-20-C-SF Octave Horn Antenna 4-8GHz 20dB Gain SMA Female



LB-OH-159-20-C-SFSPO Octave Horn Antenna 4-8GHz 20dB Gain SMA Female

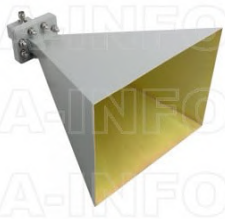

LB-OH-159-20-C-TF Octave Horn Antenna 4-8GHz 20dB Gain TNC Female



LB-OH-159-20-C-TFSPO Octave Horn Antenna 4-8GHz 20dB Gain TNC Female



LB-OH-159-20-C-7 Octave Horn Antenna 4-8GHz 20dB Gain 7mm

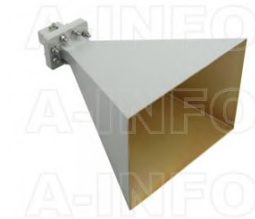

LB-OH-159-20-C-3.5F Octave Horn Antenna 4-8GHz 20dB Gain 3.5mm Female



LB-OH-159-20-C-3.5FSPO Octave Horn Antenna 4-8GHz 20dB Gain 3.5mm Female

### About this Datasheet

<ul style="list-style-type: none"> <li>● <b>Product Information</b> Product Link: <a href="https://www.ainfoinc.com/lb-oh-159-20-c-7spo-octave-horn-antenna-4-8-ghz-20db-gain-7mm-female">https://www.ainfoinc.com/lb-oh-159-20-c-7spo-octave-horn-antenna-4-8-ghz-20db-gain-7mm-female</a> Data subject to change without notice. © A-INFO INC. 2024. All Rights Reserved</li> </ul>	<ul style="list-style-type: none"> <li>● <b>Contact Us</b> Address: 60 Tesla, Irvine, CA 92618, USA  Website: <a href="http://www.ainfoinc.com">www.ainfoinc.com</a>  Email: <a href="mailto:sales@ainfoinc.com">sales@ainfoinc.com</a></li> </ul>	<ul style="list-style-type: none"> <li>● <b>Phone &amp; Fax</b> Phone: +1-949-639-9688 +1-949-639-9608  Fax: +1-949-639-9670</li> </ul>
---	--	---