

LB-OH-159-20-C-7 Octave Horn Antenna 4-8GHz 20dB Gain 7mm

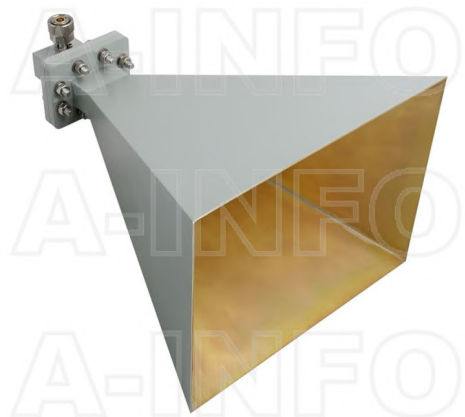

Octave Horn Antenna Operating From 4GHz to 8GHz With a Nominal 20dB Gain With 7mm Connector

Product Information

| | |
|-----|------------------|
| SKU | LB-OH-159-20-C-7 |
|-----|------------------|

Description

Octave horn antenna LB-OH-159-20-C-7, operating from 4 to 8GHz with a nominal 20dB gain and low VSWR 1.5:1 with 7mm output connector. The model LB-OH-159-20-C-7 has uniform gain through its frequency span, providing efficient performance characteristics and directionality. It can handle 150W continuously and 3000W peak power. Constructed of lightweight corrosion-resistant aluminum, the antenna will provide years of trouble-free indoor and outdoor service. This octave horn antenna is linearly polarized and ideally suited for EMI testing, direction finding, surveillance, antenna gain and pattern measurements and other applications.

Technical Specification

| Electrical Specification | | Interface | |
|------------------------------------|--------|--------------------------|---|
| Frequency, Min (GHz) | 4 | Output Type | Coaxial |
| Frequency, Max (GHz) | 8 | Connector | 7mm |
| Gain, Typ (dBi) | 20 | Connector Gender | N/A |
| Polarization | Linear | Mechanical Specification | |
| 3dB Beamwidth, E-Plane, Min (Deg.) | 12 | Body Material | Al |
| 3dB Beamwidth, E-Plane, Max (Deg.) | 21 | Finish | Chemical Conversion Coating, Gray Paint |
| 3dB Beamwidth, H-Plane, Min (Deg.) | 15 | Size, W (mm) | 225 |
| 3dB Beamwidth, H-Plane, Max (Deg.) | 22 | Size, H (mm) | 173 |
| Cross Pol. Isolation, Typ (dB) | 35 | Size, L (mm) | 315 |
| VSWR, Typ | 1.5:1 | Weight, (kg) | 1 |
| Impedance, (Ohm) | 50 | | |
| Power Handling, CW, (W) | 150 | | |
| Power Handling, Peak, (W) | 3000 | | |

Additional Information

| | | | |
|-------------|---|--------------|---|
| Application | General Purpose Indoor & Outdoor, Fixed | Solution for | Gain Reference Antenna Measurement Far-field Measurement System Intergration |
|-------------|---|--------------|---|

Outline Drawing

7mm Output (P/N: LB-OH-159-20-C-7)

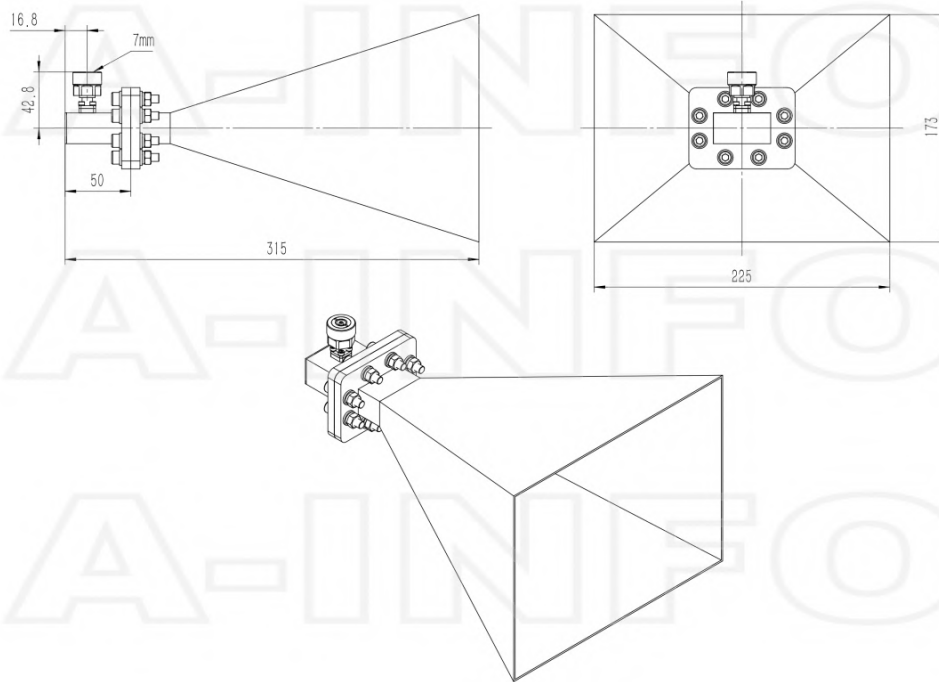

7mm Output with Round Mounting Bracket (Option, P/N: LB-159-10-C-MB)

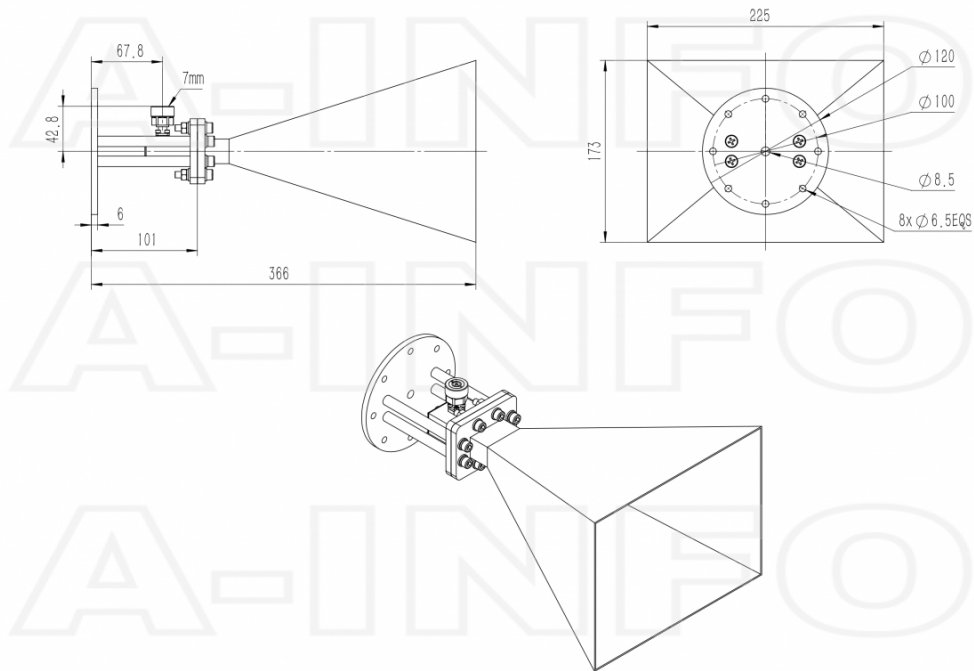

7mm Output with L Type Mounting Bracket (Option, P/N: LB-159-10-C-MBL)

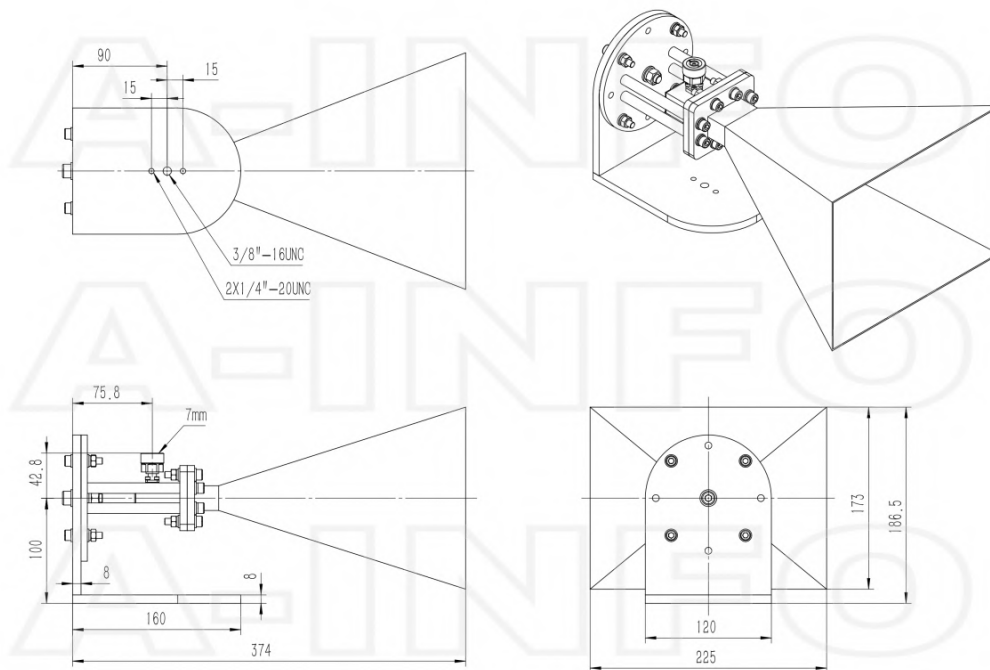

Typical Test Results

Gain

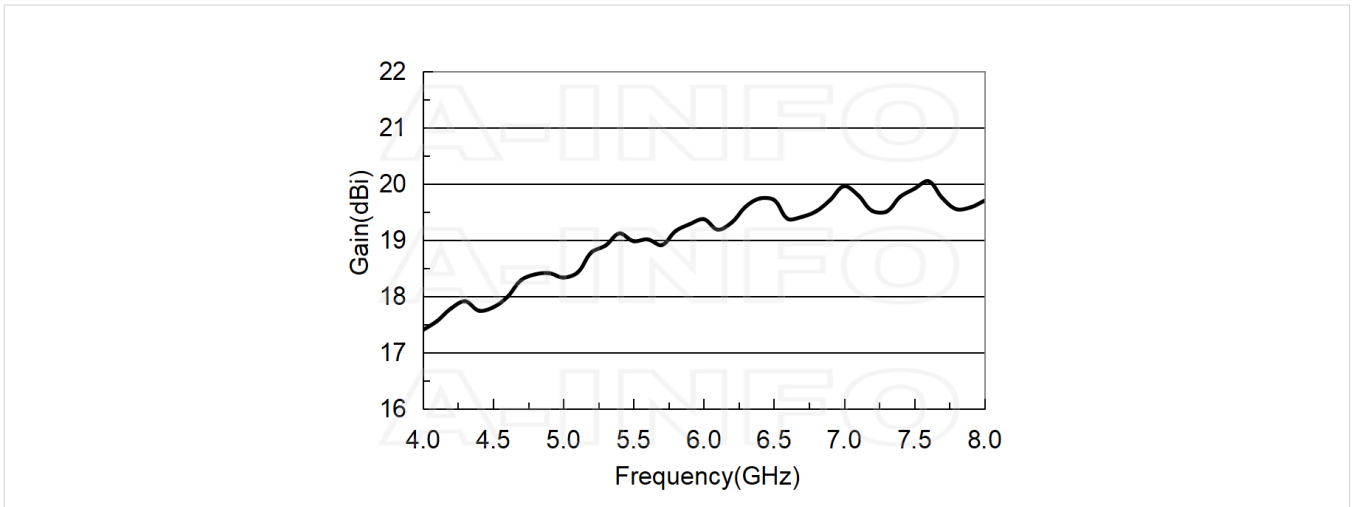

Antenna Factor

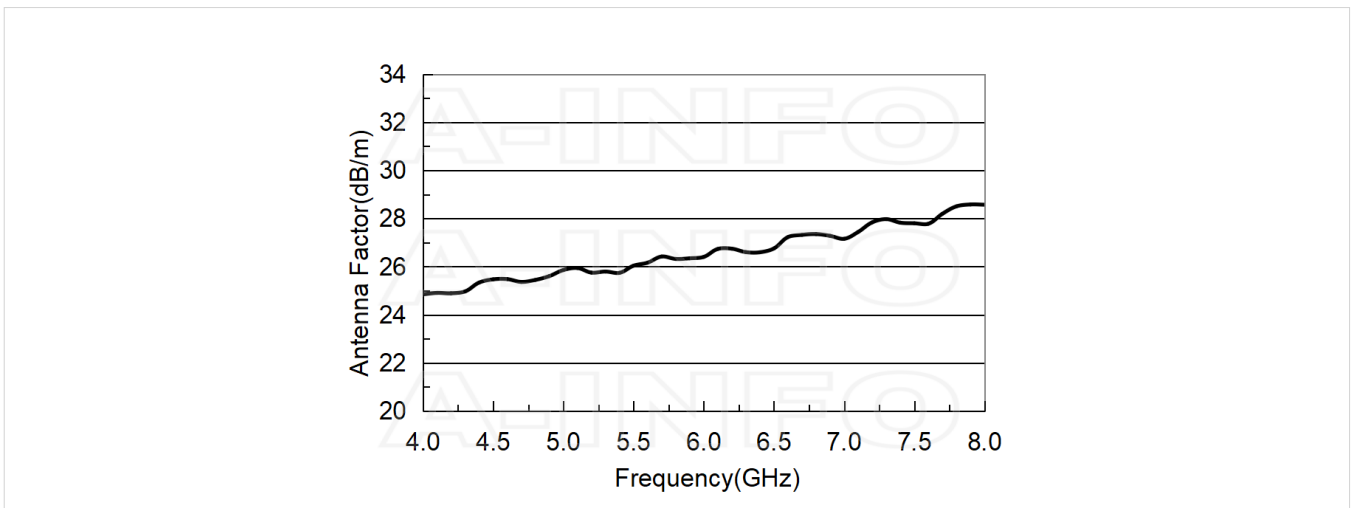

Antenna Factor (Table)

| Frequency(GHz) | Gain(dBi) | AF(dB/m) |
|----------------|-----------|----------|
| 4 | 17.40 | 24.85 |
| 4.25 | 17.82 | 24.96 |
| 4.5 | 17.80 | 25.47 |
| 4.75 | 18.34 | 25.40 |
| 5 | 18.33 | 25.86 |
| 5.25 | 18.82 | 25.79 |
| 5.5 | 18.98 | 26.04 |
| 5.75 | 19.10 | 26.31 |
| 6 | 19.37 | 26.40 |
| 6.25 | 19.54 | 26.59 |
| 6.5 | 19.71 | 26.76 |
| 6.75 | 19.47 | 27.32 |
| 7 | 19.96 | 27.16 |
| 7.25 | 19.39 | 28.03 |
| 7.5 | 19.91 | 27.80 |
| 7.75 | 19.48 | 28.52 |
| 8 | 19.70 | 28.57 |

Cross Polarization Isolation

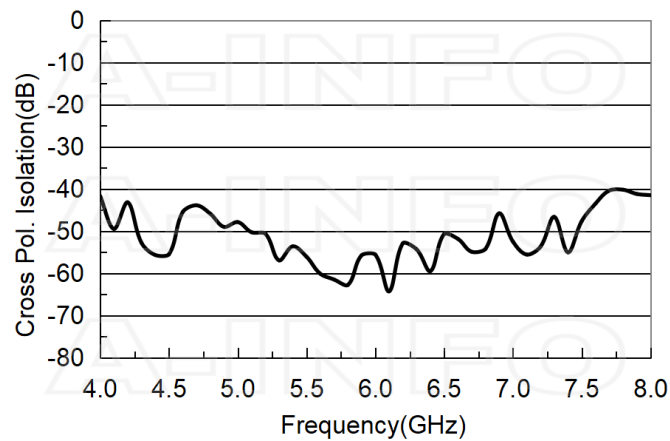

VSWR

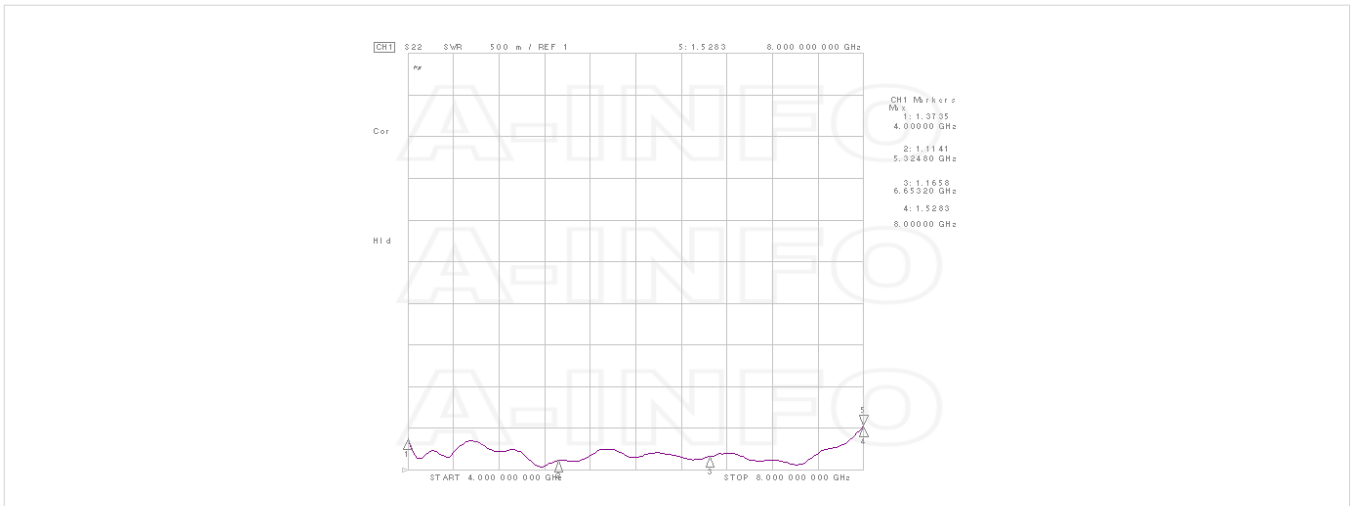

Beamwidth

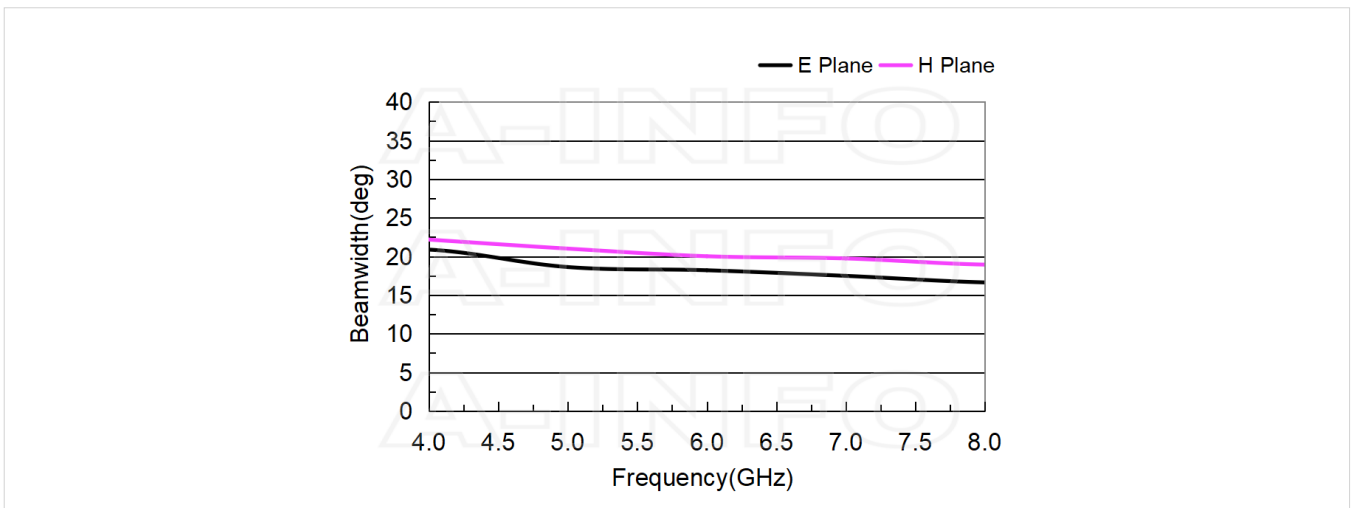

Pattern

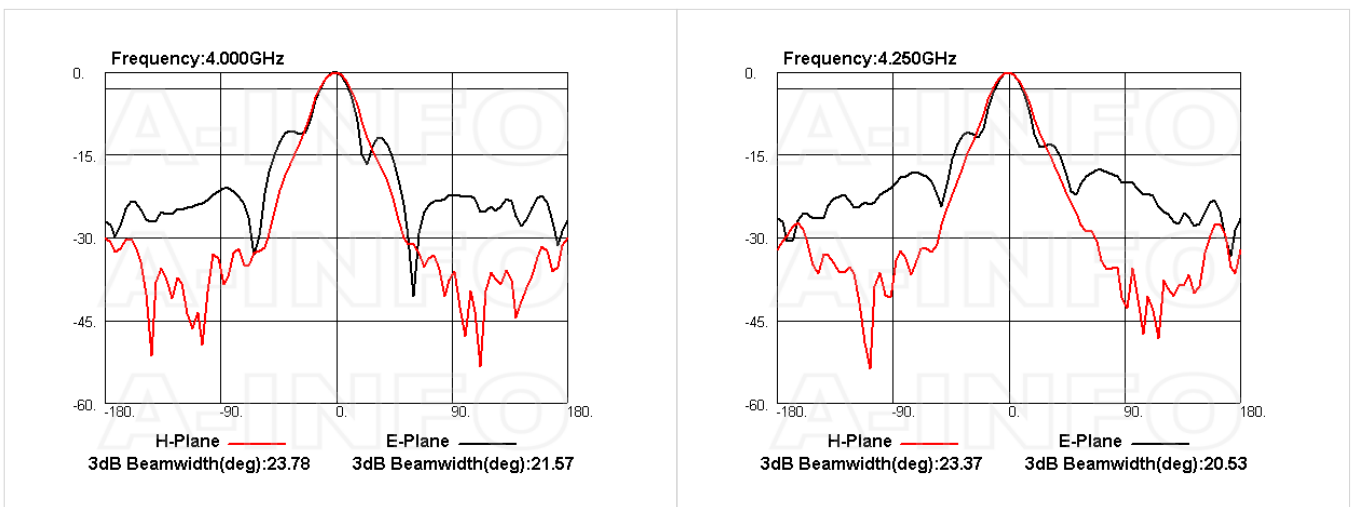

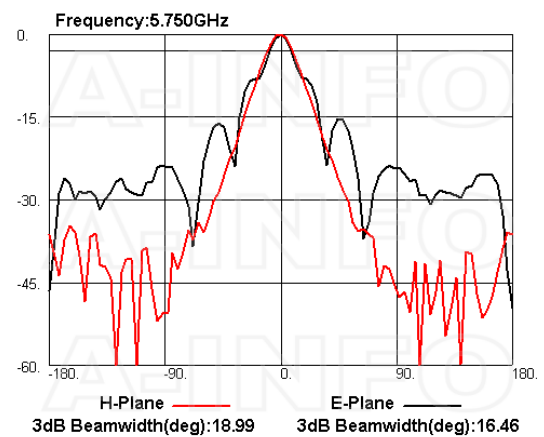
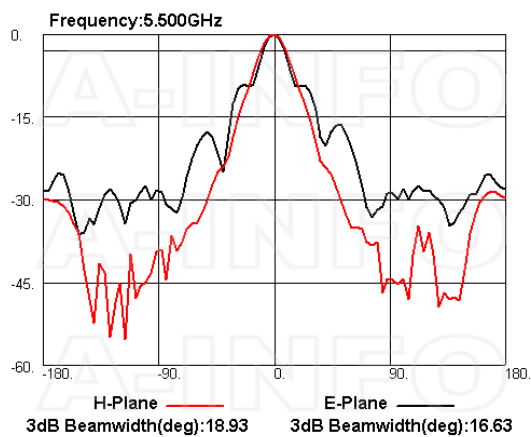
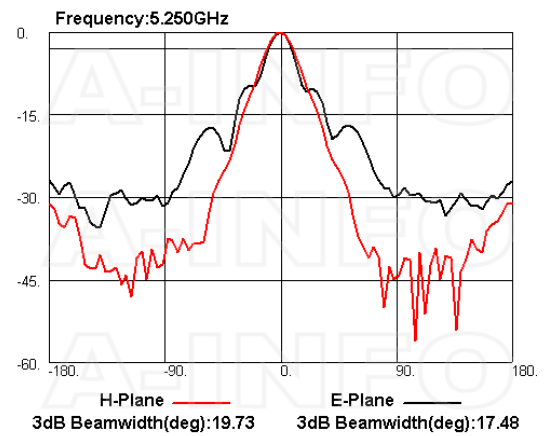
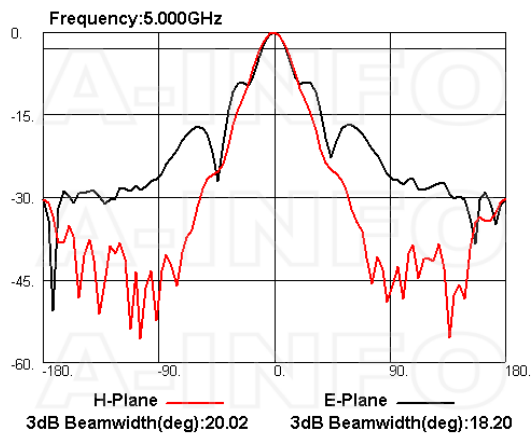
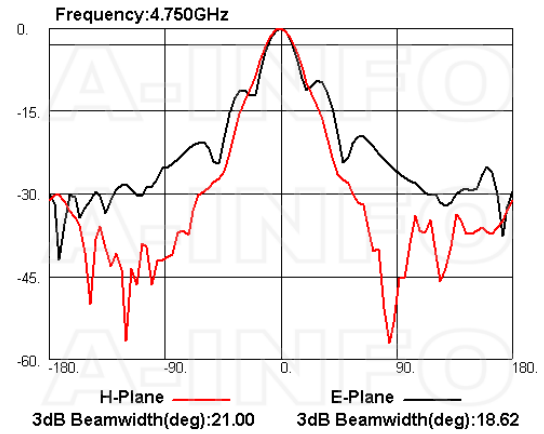
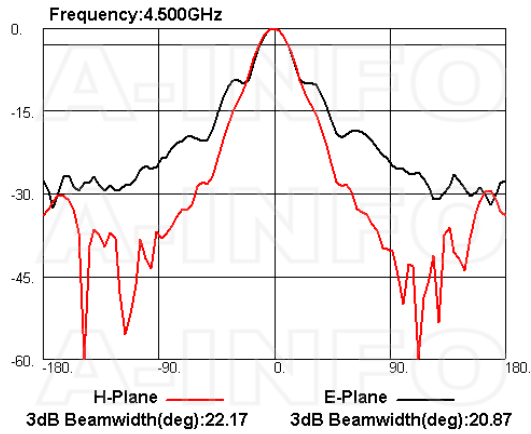

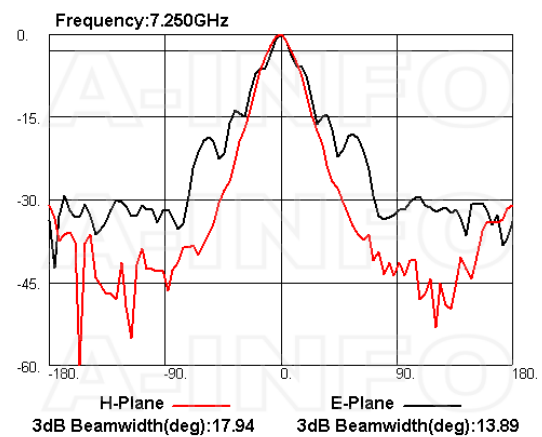
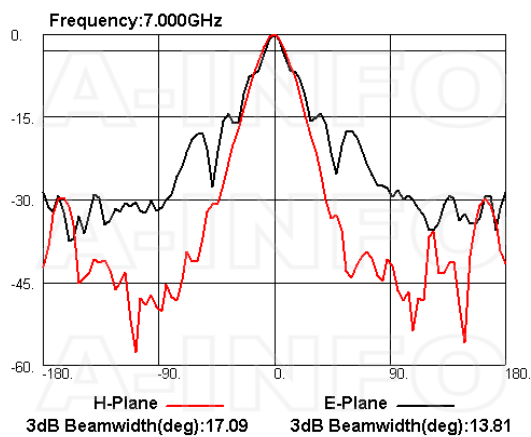
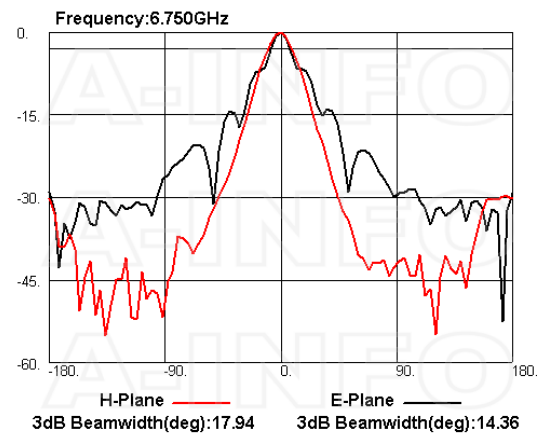
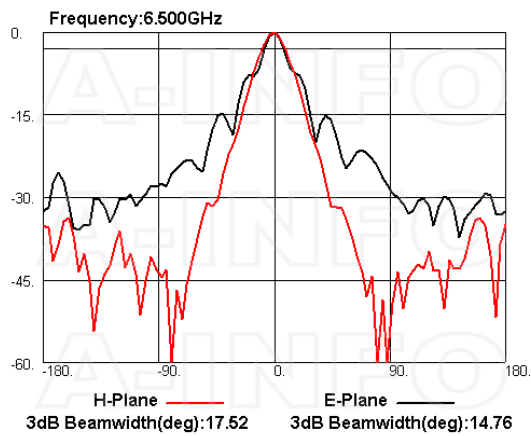
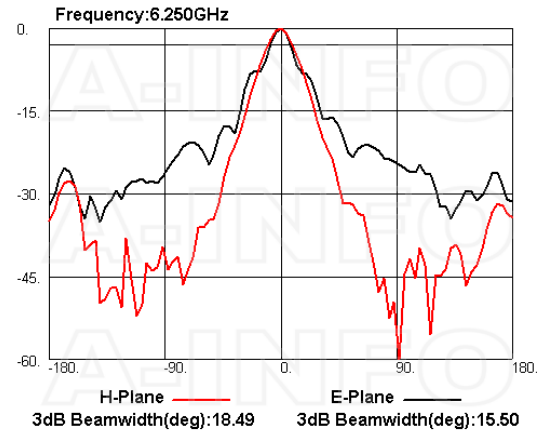
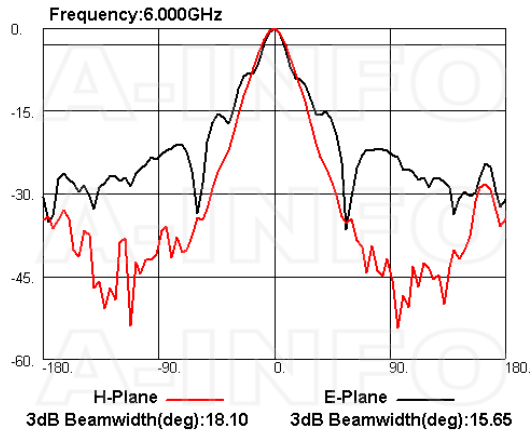

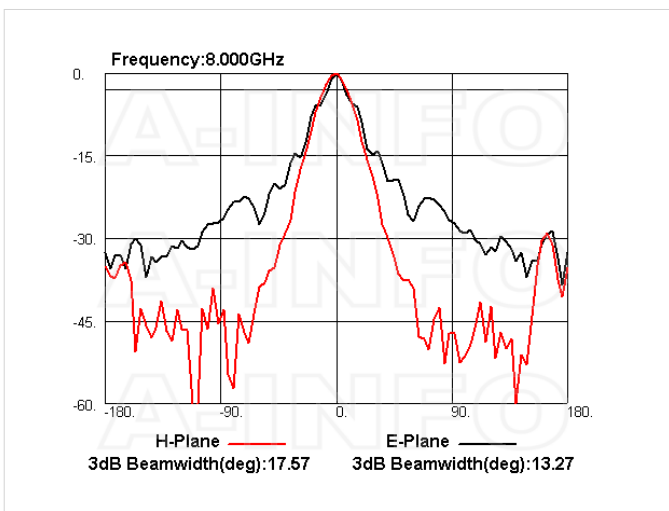
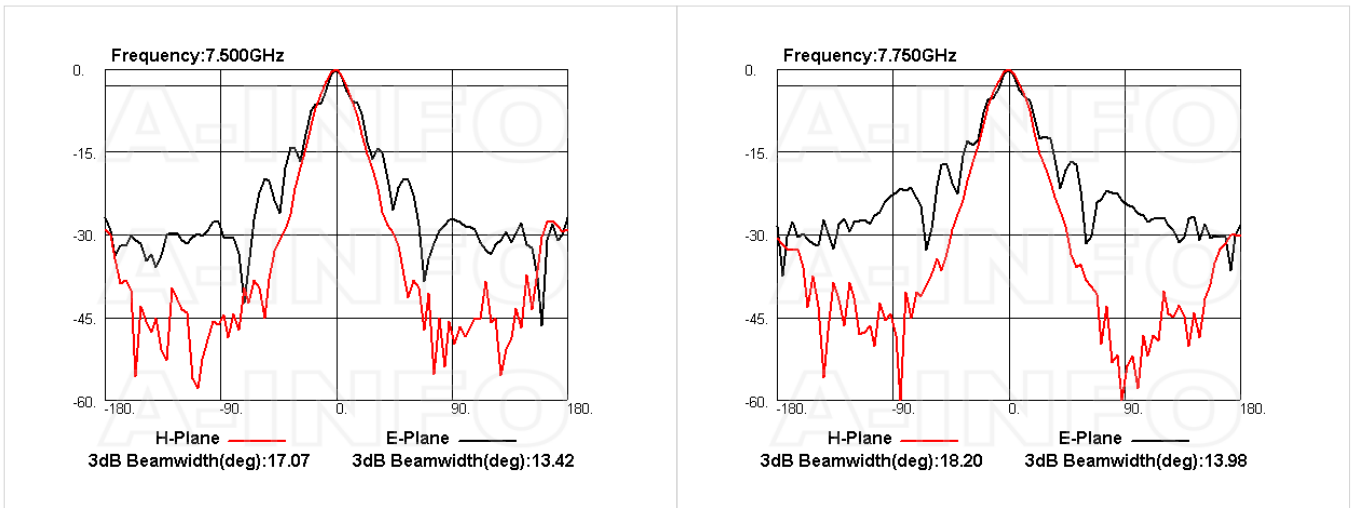

Related Products



LB-159-10-C-MB Round Type Mounting Bracket



LB-159-10-C-MBL L type mounting bracket



Tripod_50Kg Al Alloy Tripod



Carrying Case_LB-159-20-C Al Alloy Carrying Case

Similar Products

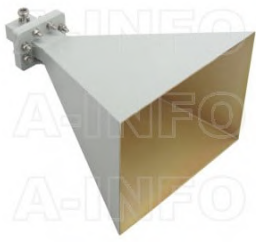

LB-OH-159-20-C-NF Octave Horn Antenna 4-8GHz 20dB Gain N Type Female



LB-OH-159-20-C-NFSPO Octave Horn Antenna 4-8GHz 20dB Gain N Type Female

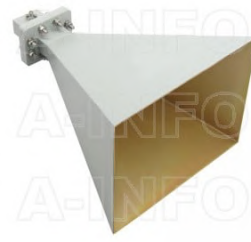

LB-OH-159-20-C-SF Octave Horn Antenna 4-8GHz 20dB Gain SMA Female



LB-OH-159-20-C-SFSPO Octave Horn Antenna 4-8GHz 20dB Gain SMA Female

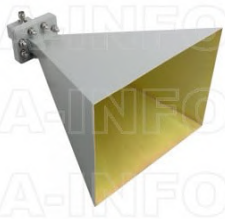

LB-OH-159-20-C-TF Octave Horn Antenna 4-8GHz 20dB Gain TNC Female



LB-OH-159-20-C-TFSPO Octave Horn Antenna 4-8GHz 20dB Gain TNC Female



LB-OH-159-20-C-7SPO Octave Horn Antenna 4-8GHz 20dB Gain 7mm

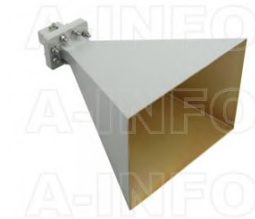

LB-OH-159-20-C-3.5F Octave Horn Antenna 4-8GHz 20dB Gain 3.5mm Female



LB-OH-159-20-C-3.5FSPO Octave Horn Antenna 4-8GHz 20dB Gain 3.5mm Female

About this Datasheet

- **Product Information**

Product Link:
<https://www.ainfoinc.com/lb-oh-159-20-c-7-octave-horn-antenna-4-8-ghz-20db-gain-7mm-female>
 Data subject to change without notice.
 © A-INFO INC. 2024. All Rights Reserved

- **Contact Us**

Address:
 60 Tesla, Irvine, CA 92618, USA

Website:
www.ainfoinc.com

Email:
sales@ainfoinc.com

- **Phone & Fax**

Phone:
 +1-949-639-9688
 +1-949-639-9608

Fax:
 +1-949-639-9670