

LB-OH-159-20-C-3.5F Octave Horn Antenna 4-8GHz 20dB Gain 3.5mm Female

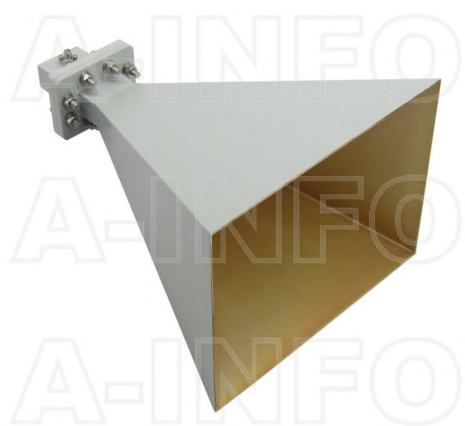

Octave Horn Antenna Operating From 4GHz to 8GHz With a Nominal 20dB Gain With 3.5mm Female Connector

Product Information

SKU	LB-OH-159-20-C-3.5F
-----	---------------------

Description

Octave horn antenna LB-OH-159-20-C-3.5F, operating from 4 to 8GHz with a nominal 20dB gain and low VSWR 1.5:1 with 3.5mm Female output connector. The model LB-OH-159-20-C-3.5F has uniform gain through its frequency span, providing efficient performance characteristics and directionality. It can handle 50W continuously and 100W peak power. Constructed of lightweight corrosion-resistant aluminum, the antenna will provide years of trouble-free indoor and outdoor service. This octave horn antenna is linearly polarized and ideally suited for EMI testing, direction finding, surveillance, antenna gain and pattern measurements and other applications.

Technical Specification

Electrical Specification		Interface	
Frequency, Min (GHz)	4	Output Type	Coaxial
Frequency, Max (GHz)	8	Connector	3.5mm
Gain, Typ (dBi)	20	Connector Gender	Female
Polarization	Linear	Mechanical Specification	
3dB Beamwidth, E-Plane, Min (Deg.)	12	Body Material	Al
3dB Beamwidth, E-Plane, Max (Deg.)	21	Finish	Chemical Conversion Coating, Gray Paint
3dB Beamwidth, H-Plane, Min (Deg.)	15	Size, W (mm)	225
3dB Beamwidth, H-Plane, Max (Deg.)	22	Size, H (mm)	173
Cross Pol. Isolation, Typ (dB)	35	Size, L (mm)	315
VSWR, Typ	1.5:1	Weight, (kg)	1
Impedance, (Ohm)	50		
Power Handling, CW, (W)	50		
Power Handling, Peak, (W)	100		

Additional Information

Application	General Purpose Indoor & Outdoor, Fixed	Solution for	Gain Reference Antenna Measurement Far-field Measurement System Intergration
-------------	---	--------------	---

Outline Drawing

3.5mm-Female Output (P/N: LB-OH-159-20-C-3.5F)

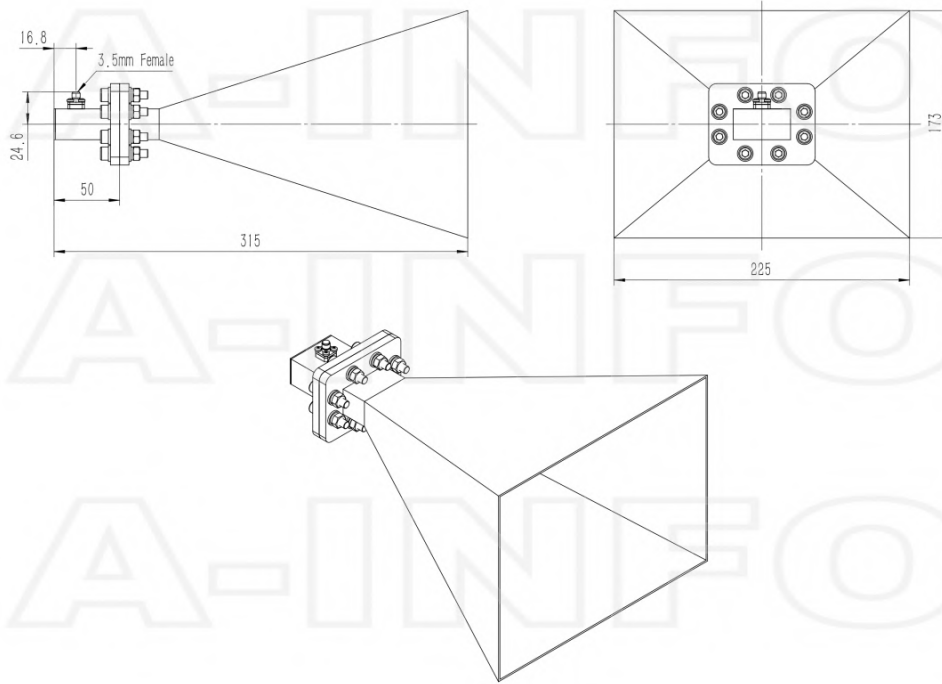

3.5mm-Female Output with Round Mounting Bracket (Option, P/N: LB-159-10-C-MB)

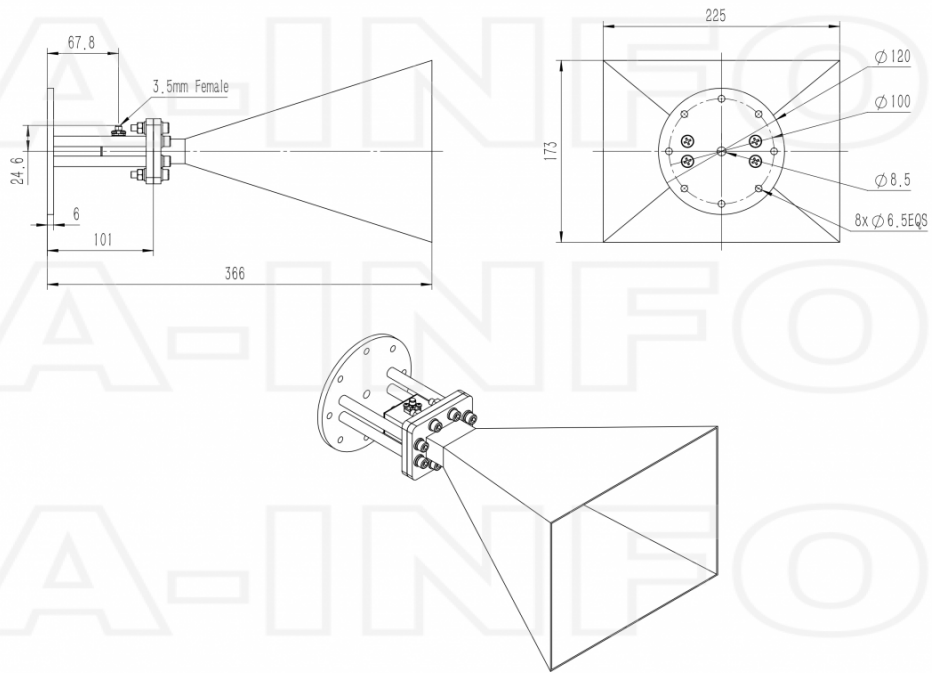

3.5mm-Female Output with L Type Mounting Bracket (Option, P/N: LB-159-10-C-MBL)

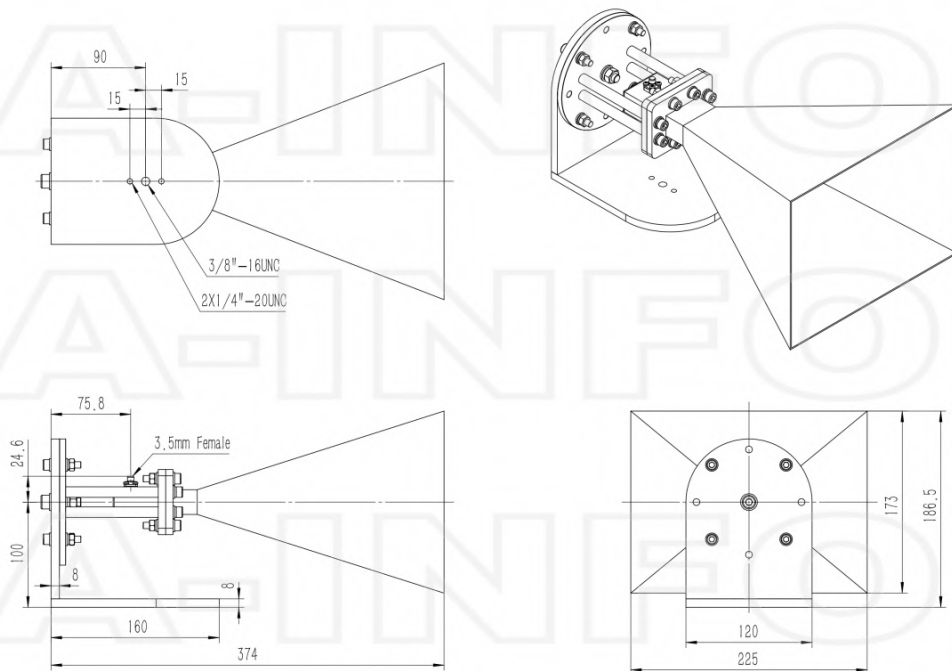

Typical Test Results

Gain

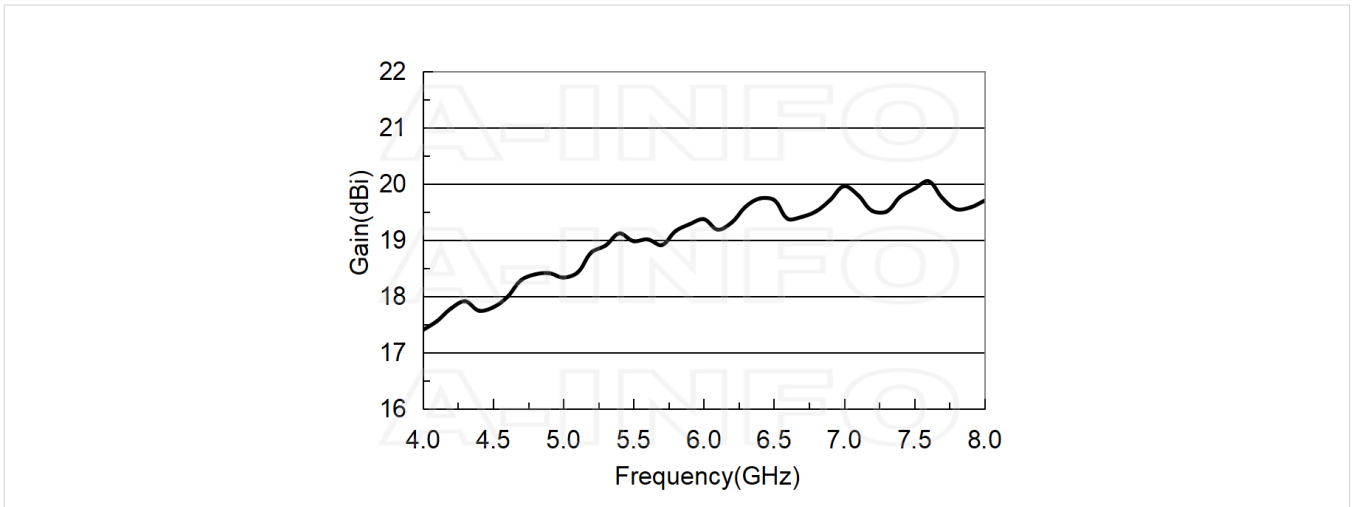

Antenna Factor

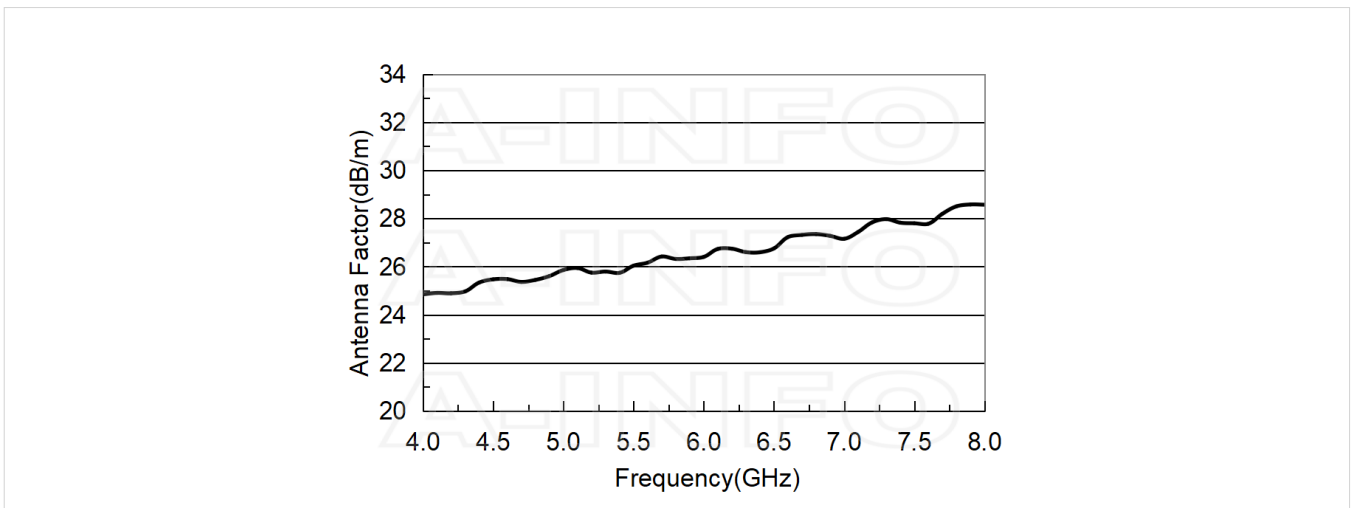

Antenna Factor (Table)

Frequency(GHz)	Gain(dBi)	AF(dB/m)
4	17.40	24.85
4.25	17.82	24.96
4.5	17.80	25.47
4.75	18.34	25.40
5	18.33	25.86
5.25	18.82	25.79
5.5	18.98	26.04
5.75	19.10	26.31
6	19.37	26.40
6.25	19.54	26.59
6.5	19.71	26.76
6.75	19.47	27.32
7	19.96	27.16
7.25	19.39	28.03
7.5	19.91	27.80
7.75	19.48	28.52
8	19.70	28.57

Cross Polarization Isolation

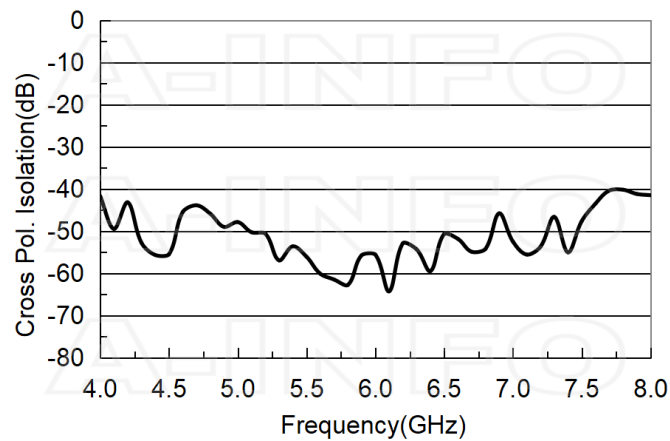

VSWR

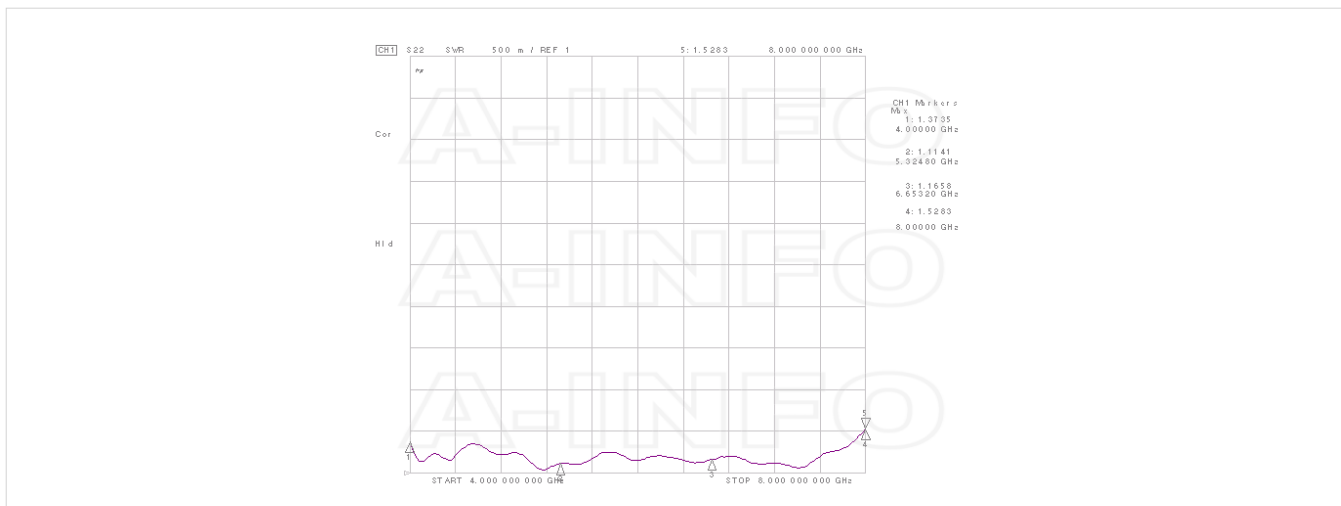

Beamwidth

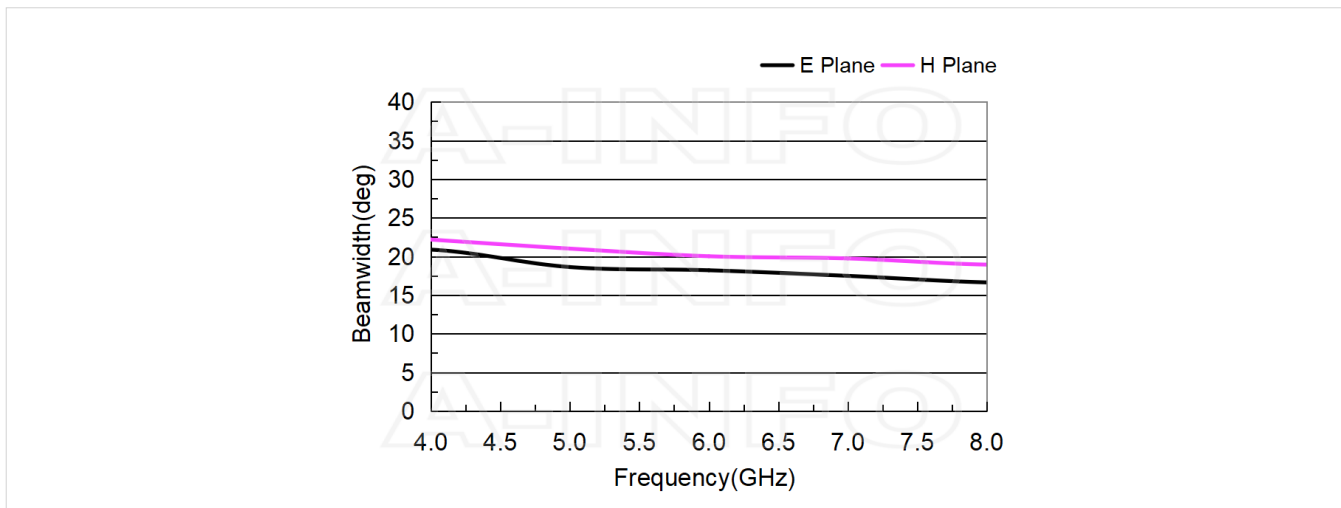

Pattern

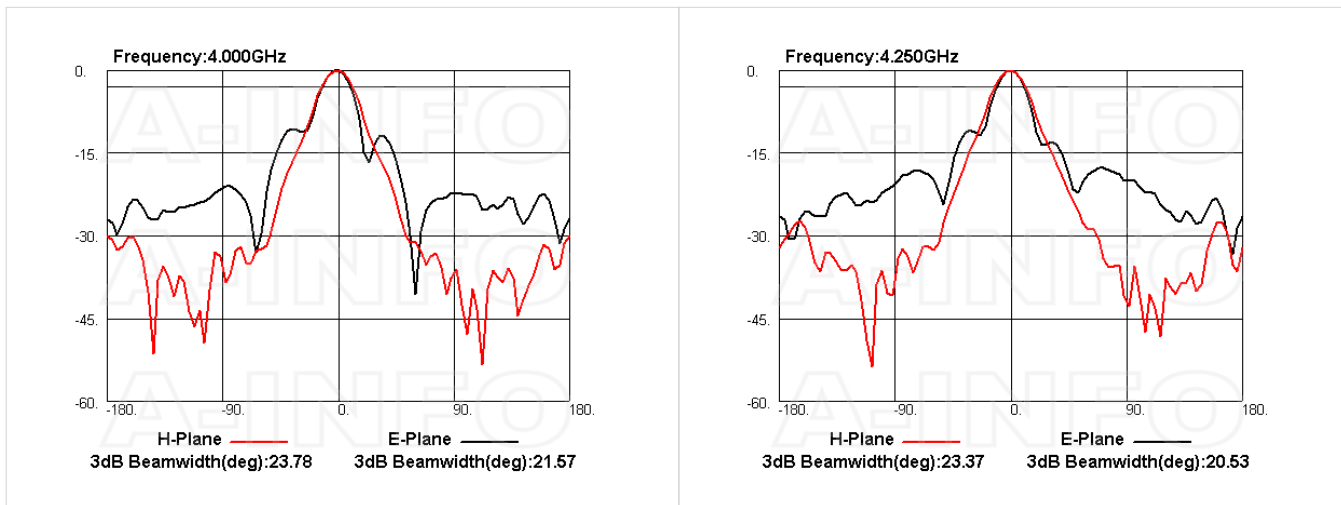

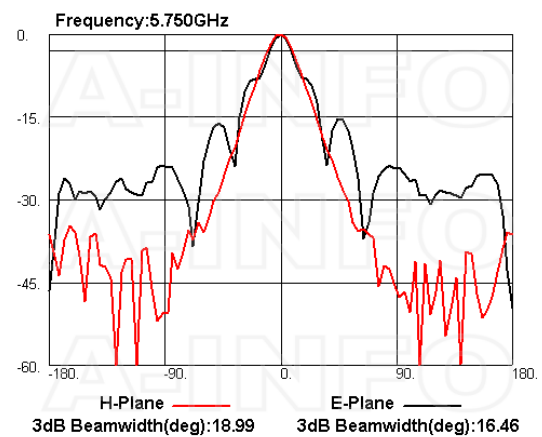
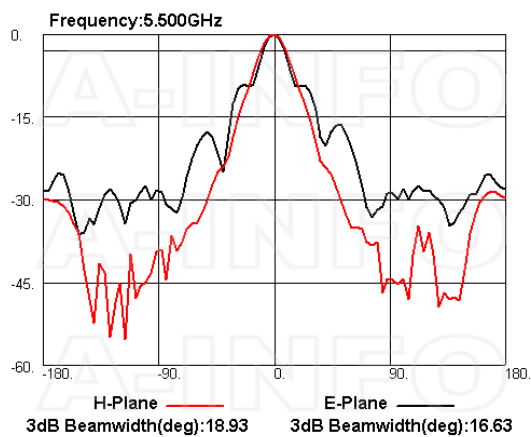
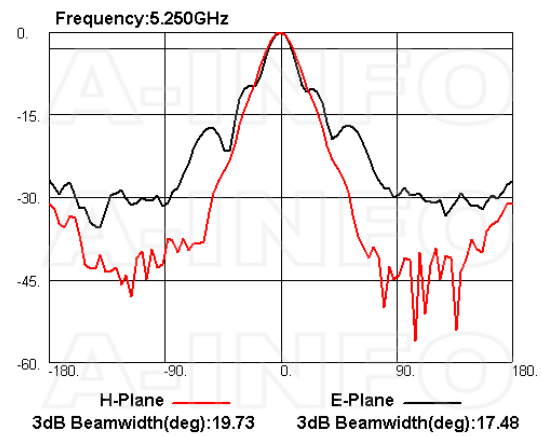
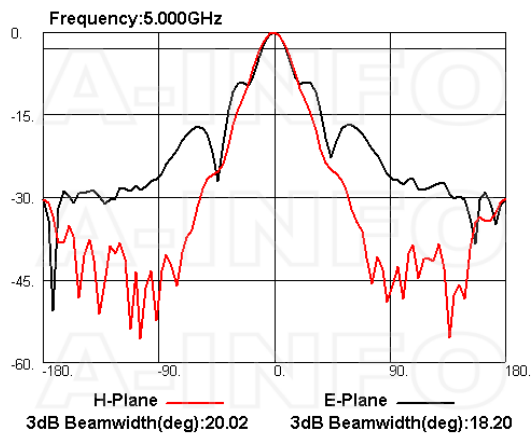
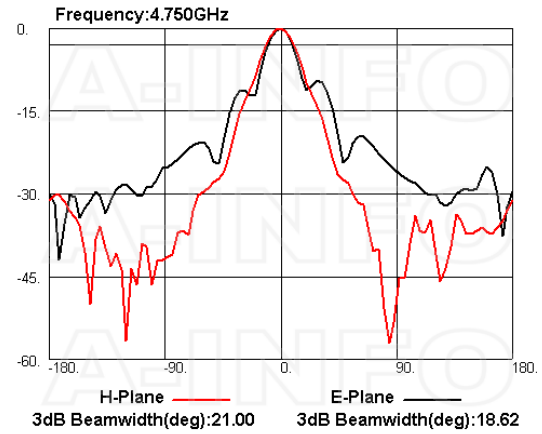
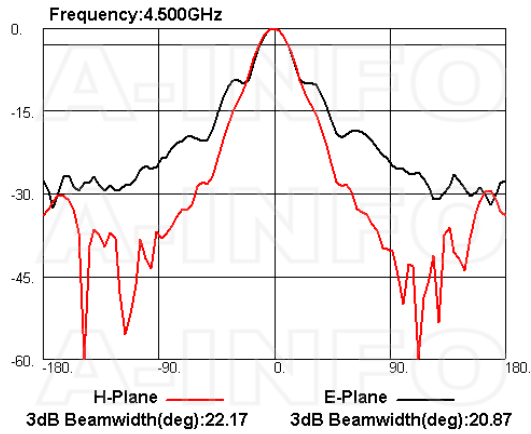

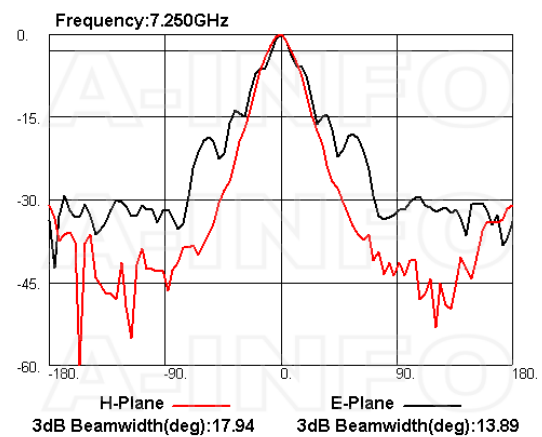
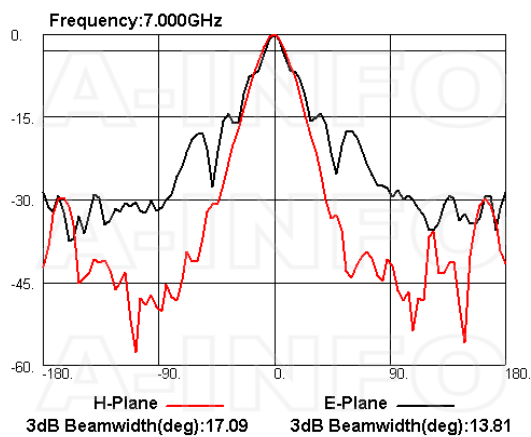
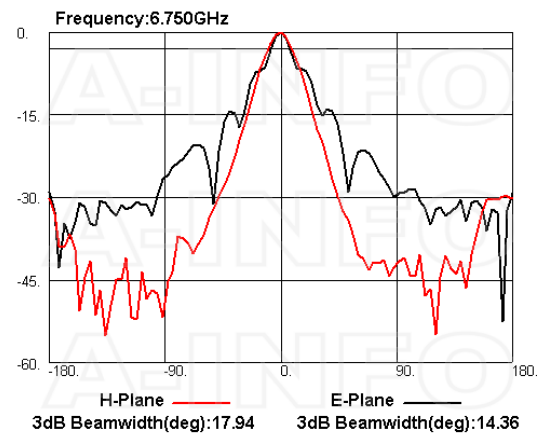
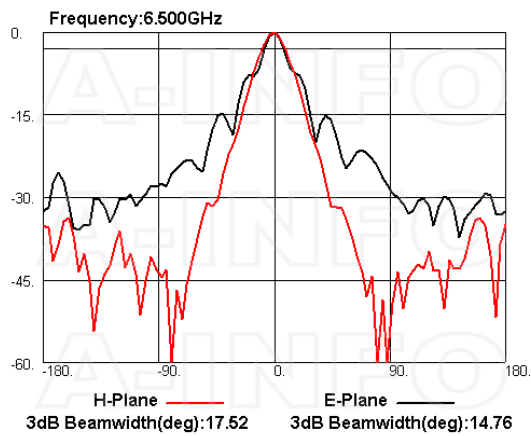
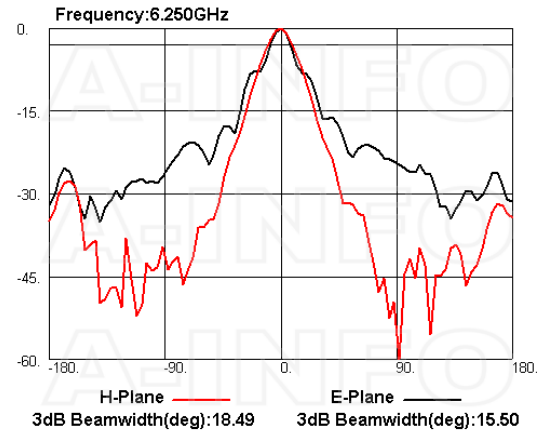
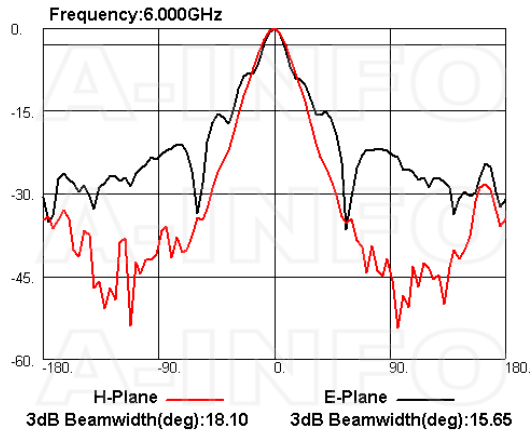

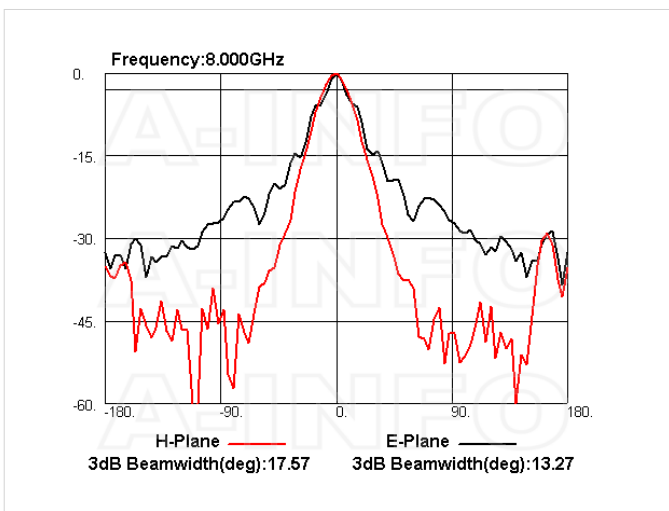
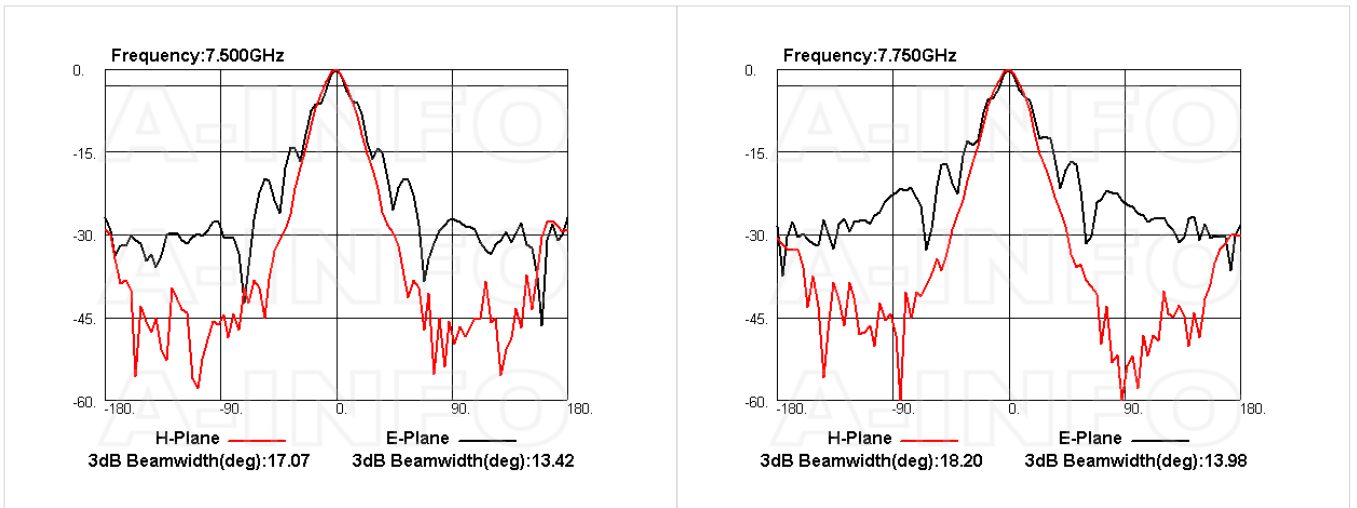

Related Products



LB-159-10-C-MB Round Type Mounting Bracket



LB-159-10-C-MBL L type mounting bracket



Tripod_50Kg Al Alloy Tripod



Carrying Case_LB-159-20-C Al Alloy Carrying Case

Similar Products

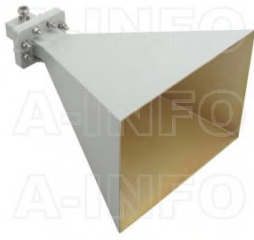

LB-OH-159-20-C-NF Octave Horn Antenna 4-8GHz 20dB Gain N Type Female



LB-OH-159-20-C-NFSPO Octave Horn Antenna 4-8GHz 20dB Gain N Type Female

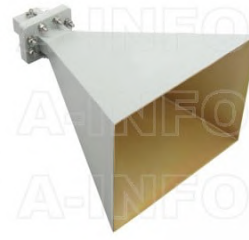

LB-OH-159-20-C-SF Octave Horn Antenna 4-8GHz 20dB Gain SMA Female



LB-OH-159-20-C-SFSPO Octave Horn Antenna 4-8GHz 20dB Gain SMA Female

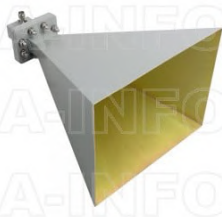

LB-OH-159-20-C-TF Octave Horn Antenna 4-8GHz 20dB Gain TNC Female



LB-OH-159-20-C-TFSPO Octave Horn Antenna 4-8GHz 20dB Gain TNC Female



LB-OH-159-20-C-7 Octave Horn Antenna 4-8GHz 20dB Gain 7mm



LB-OH-159-20-C-7SPO Octave Horn Antenna 4-8GHz 20dB Gain 7mm



LB-OH-159-20-C-3.5FSPO Octave Horn Antenna 4-8GHz 20dB Gain 3.5mm Female

About this Datasheet

- **Product Information**

Product Link:
<https://www.ainfoinc.com/lb-oh-159-20-c-3-5f-octave-horn-antenna-4-8-ghz-20db-gain-3-5mm-female>
 Data subject to change without notice.
 © A-INFO INC. 2024. All Rights Reserved

- **Contact Us**

Address:
 60 Tesla, Irvine, CA 92618, USA

Website:
www.ainfoinc.com

Email:
sales@ainfoinc.com

- **Phone & Fax**

Phone:
 +1-949-639-9688
 +1-949-639-9608

Fax:
 +1-949-639-9670