

LB-OH-159-15-C-SFSP0 Octave Horn Antenna 4-8GHz 15dB Gain SMA Female

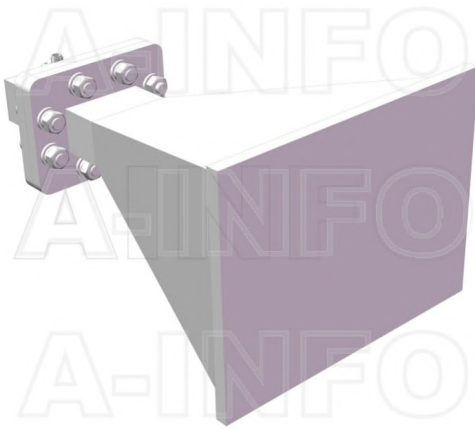

Octave Horn Antenna Operating From 4GHz to 8GHz With a Nominal 15dB Gain With SMA Female Connector

Product Information

SKU	LB-OH-159-15-C-SFSP0
-----	----------------------

Description

Octave horn antenna LB-OH-159-15-C-SFSP0, operating from 4 to 8GHz with a nominal 15dB gain and low VSWR 1.5:1 with SMA Female output connector. The model LB-OH-159-15-C-SFSP0 has uniform gain through its frequency span, providing efficient performance characteristics and directionality. It can handle 50W continuously and 3000W peak power. Constructed of lightweight corrosion-resistant aluminum, the horn comes with a specially designed weatherproof radome which provides excellent protection against the rain and dust but has very little loss across the full operating frequency band. This octave horn antenna is linearly polarized and ideally suited for EMI testing, direction finding, surveillance, antenna gain and pattern measurements and other applications.

Technical Specification

Electrical Specification		Interface	
Frequency, Min (GHz)	4	Output Type	Coaxial
Frequency, Max (GHz)	8	Connector	SMA
Gain, Typ (dBi)	15	Connector Gender	Female
Polarization	Linear	Mechanical Specification	
3dB Beamwidth, E-Plane, Min (Deg.)	17	Body Material	Al
3dB Beamwidth, E-Plane, Max (Deg.)	44	Finish	Chemical Conversion Coating, Gray Paint
3dB Beamwidth, H-Plane, Min (Deg.)	18	Size, W (mm)	145
3dB Beamwidth, H-Plane, Max (Deg.)	40	Size, H (mm)	110
Cross Pol. Isolation, Typ (dB)	40	Size, L (mm)	233
VSWR, Typ	1.5:1	Weight, (kg)	0.7
Impedance, (Ohm)	50		
Power Handling, CW, (W)	50		
Power Handling, Peak, (W)	3000		

Additional Information

Application	Outdoor, Waterproof and Dustproof, Fixed	Solution for	Gain Reference Antenna Measurement Far-field Measurement System Intergration
-------------	--	--------------	---

Outline Drawing

SMA-Female Output with Radome (Option, P/N: LB-OH-159-15-C-SFSP0, Outdoor Application)

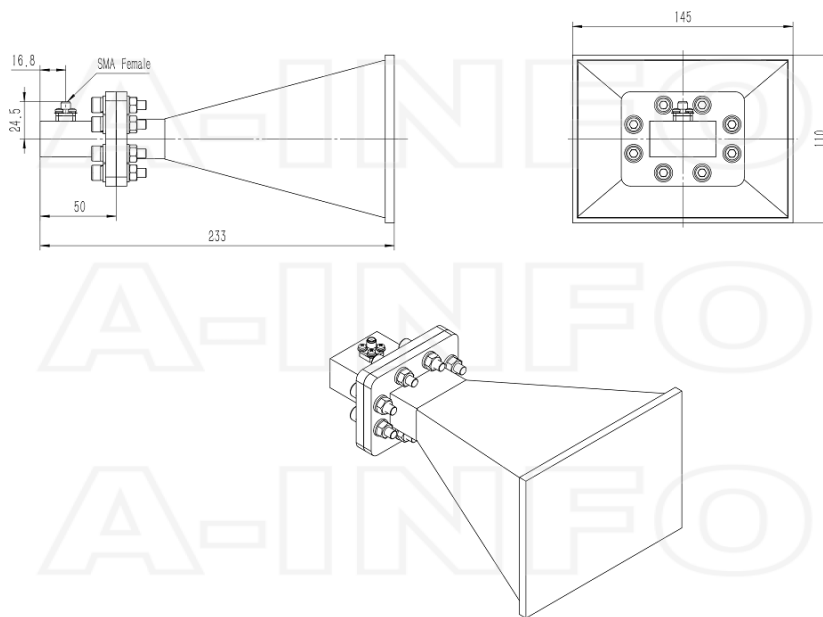

SMA-Female Output with Round Mounting Bracket & Radome (Option, P/N: LB-159-10-C-MB & LB-OH-159-15-C-SFSP0, Outdoor Application)

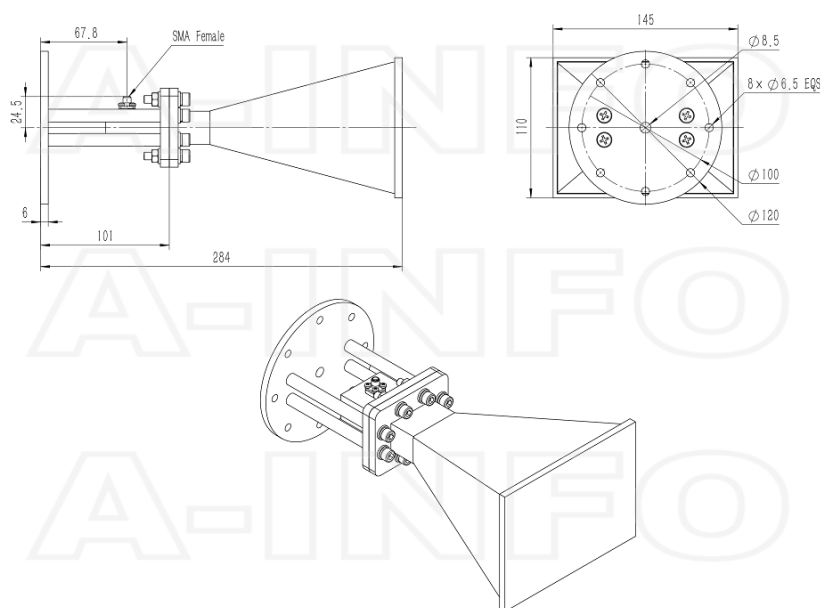

SMA-Female Output with L Type Mounting Bracket & Radome (Option, P/N: LB-159-10-C-MBL & LB-OH-159-15-C-SFSP0, Outdoor Application)

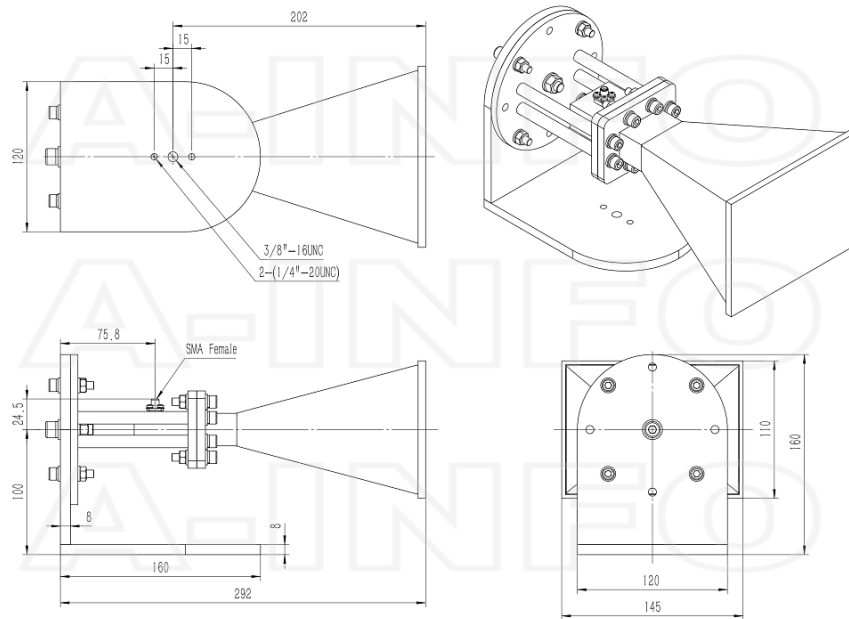

Typical Test Results

Gain

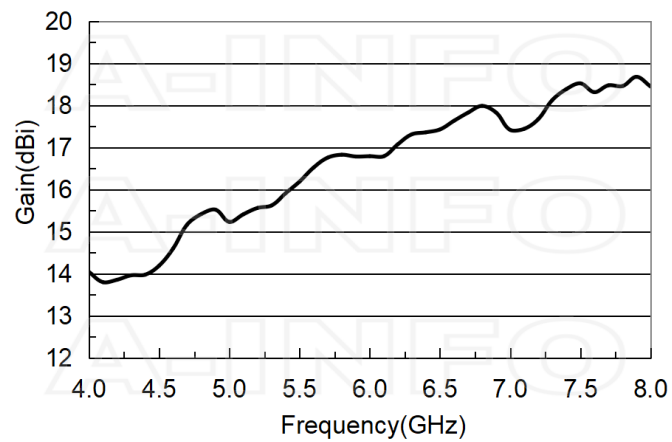

Antenna Factor

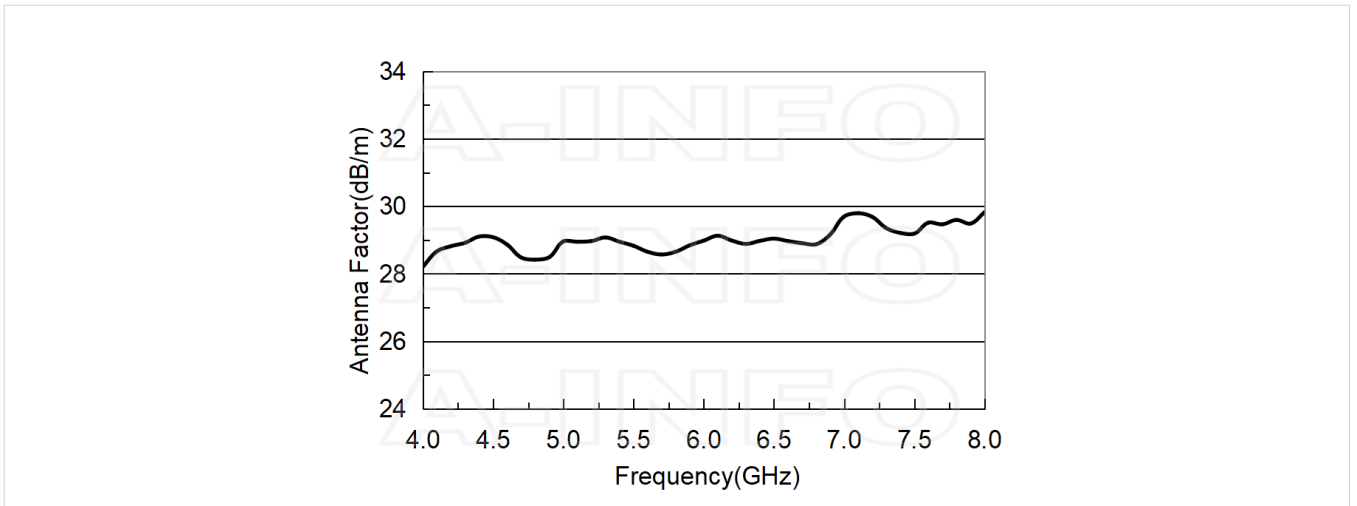

Antenna Factor (Table)

Frequency(GHz)	Gain(dBi)	AF(dB/m)
4	14.04	28.21
4.25	13.85	28.93
4.5	14.19	29.08
4.75	15.29	28.45
5	15.23	28.96
5.25	15.49	29.13
5.5	16.19	28.83
5.75	16.90	28.50
6	16.79	28.98
6.25	17.17	28.96
6.5	17.43	29.04
6.75	18.00	28.80
7	17.42	29.70
7.25	17.86	29.56
7.5	18.52	29.19
7.75	18.46	29.54
8	18.45	29.82

Cross Polarization Isolation

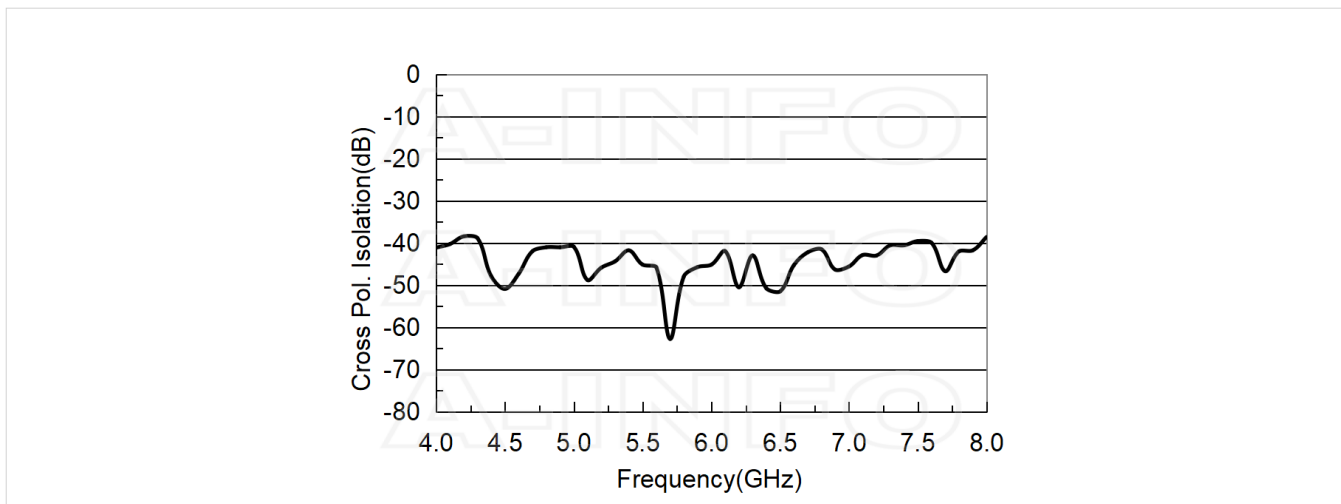

VSWR

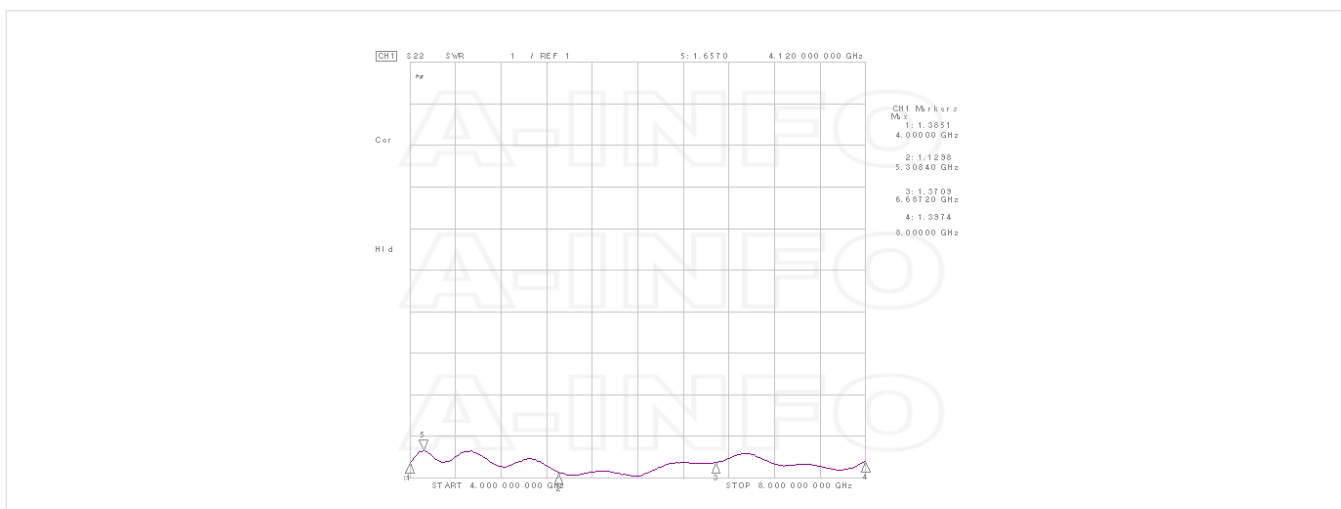

Beamwidth

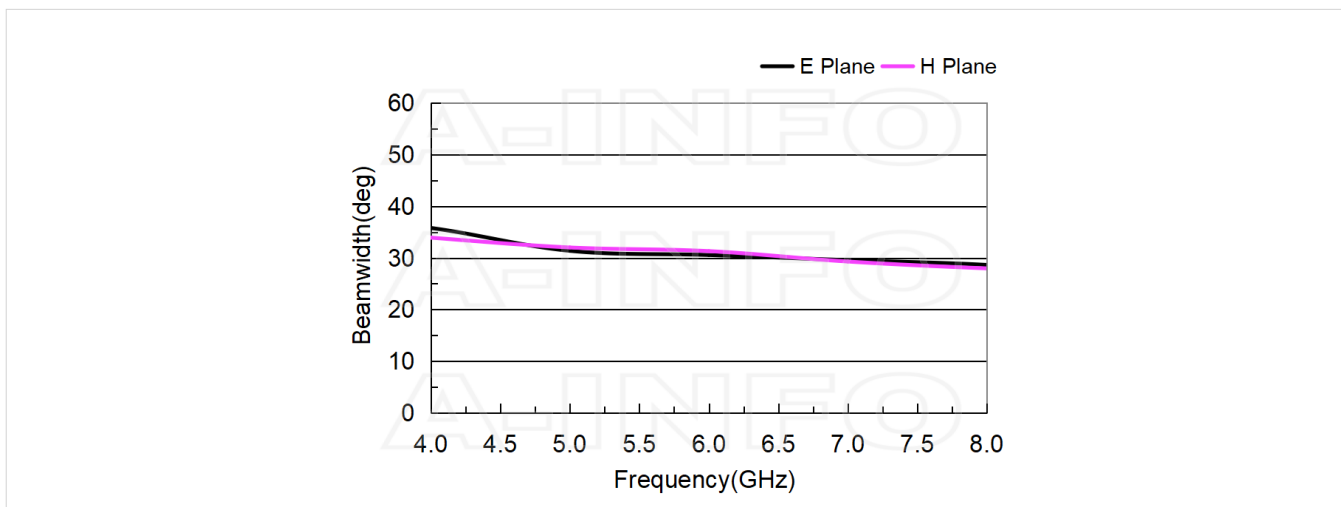

Pattern

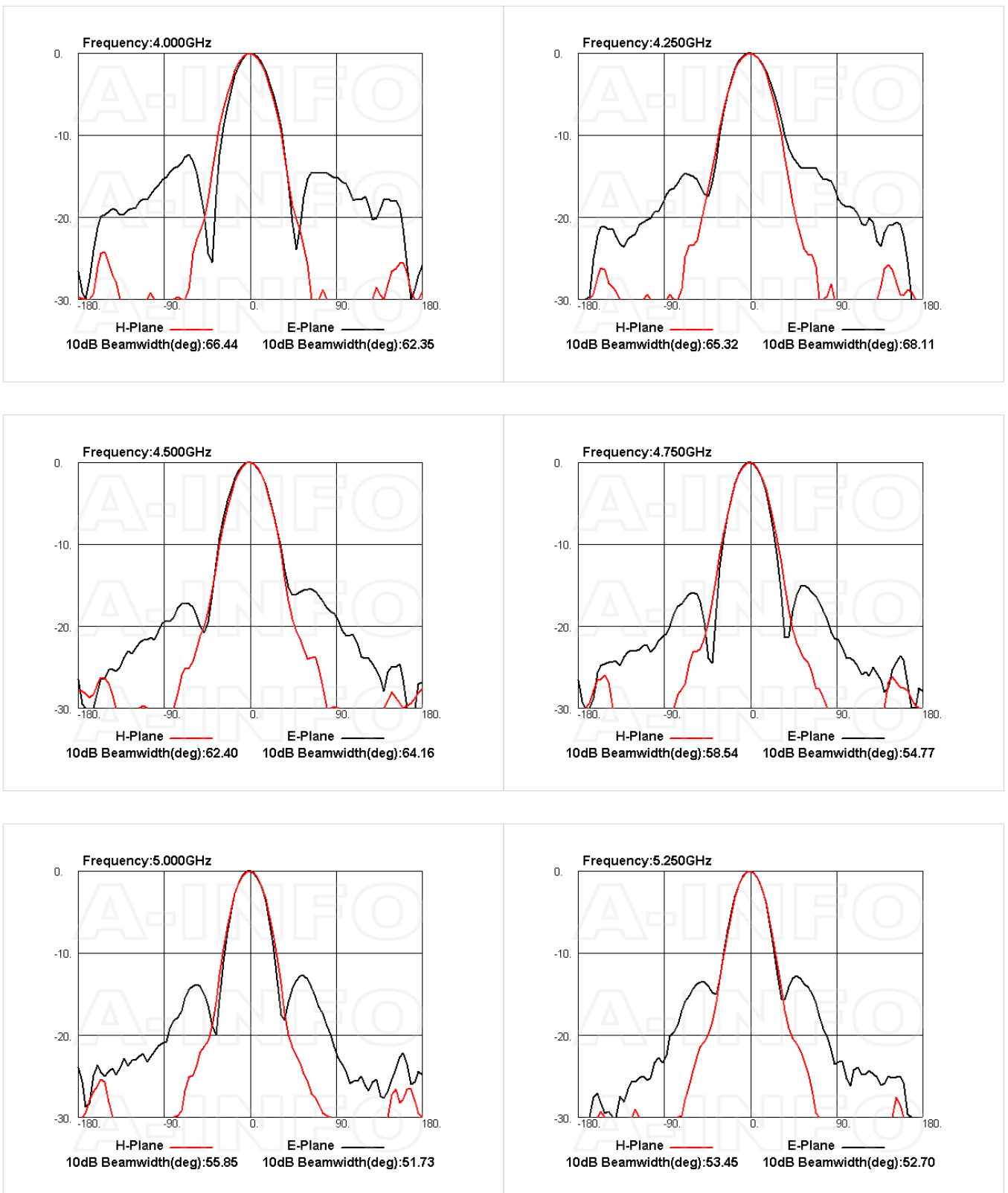

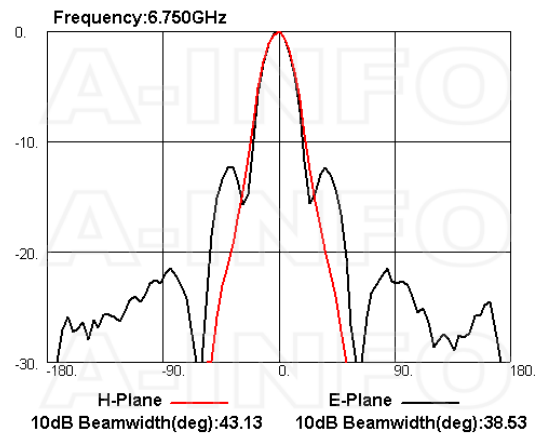
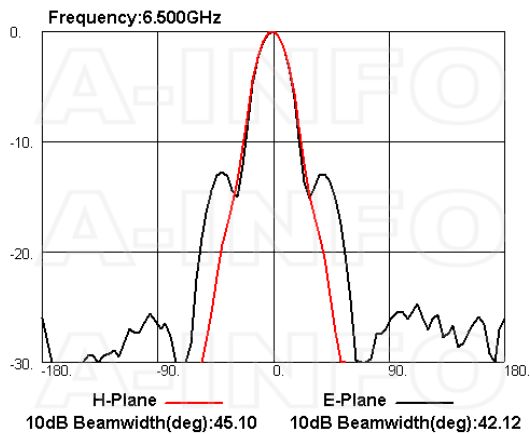
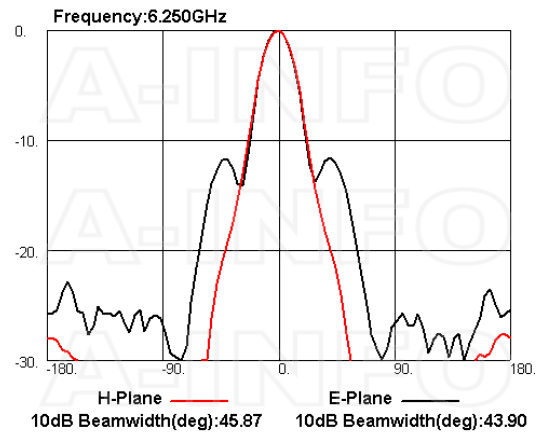
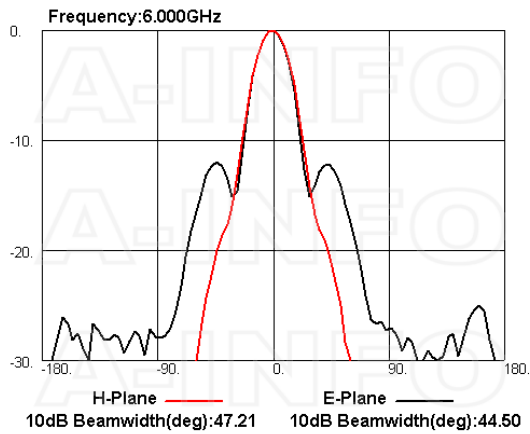
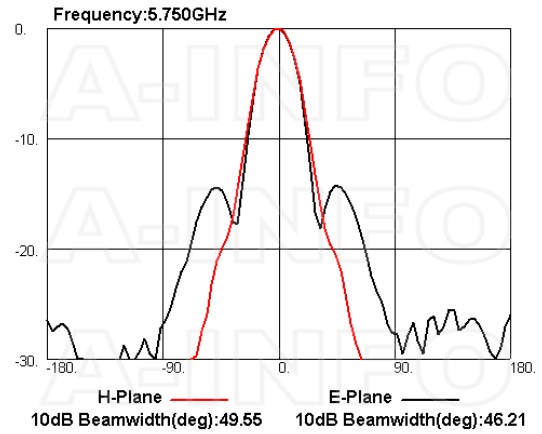
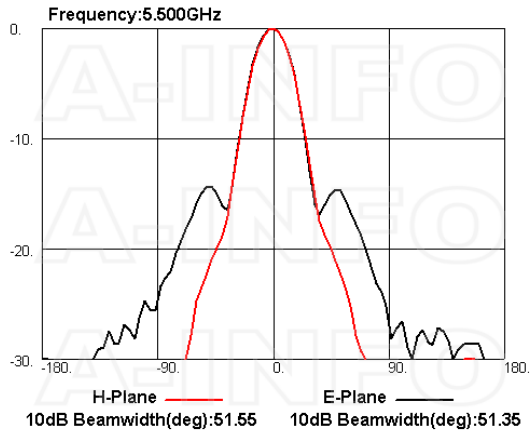

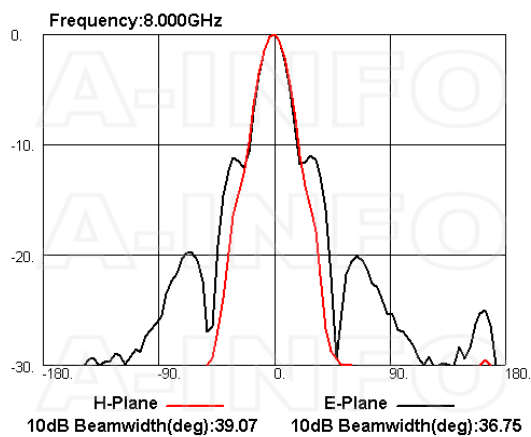
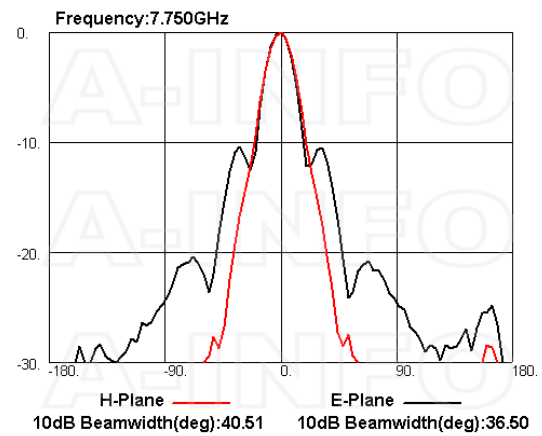
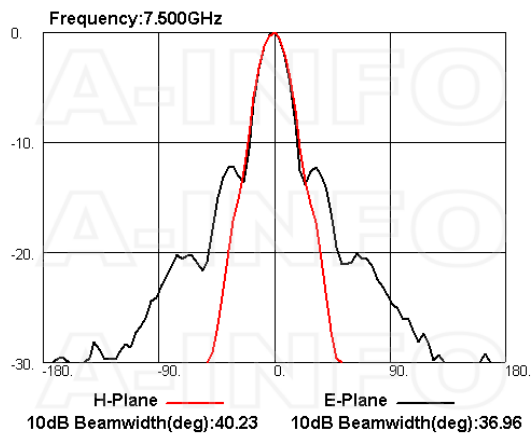
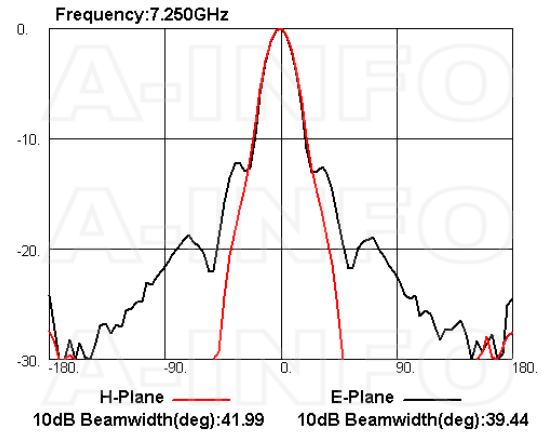
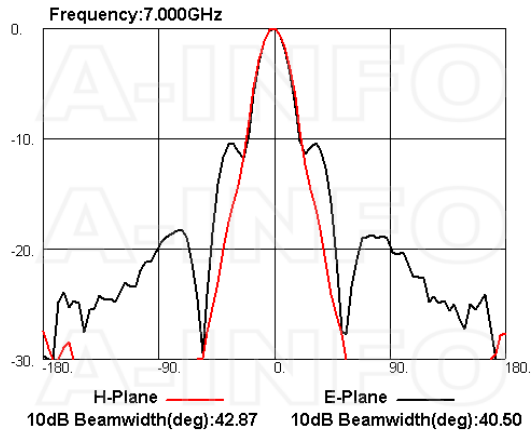

Related Products



LB-159-10-C-MB Round Type Mounting Bracket



LB-159-10-C-MBL L type mounting bracket



SM-SM-A050-1000 Flexible Cable Assembly 1000mm DC- 26.5GHz SMA Male to SMA Male



SM-SM-A050-1500 Flexible Cable Assembly 1500mm DC- 26.5GHz SMA Male to SMA Male



SM-SM-A050-2000 Flexible Cable Assembly 2000mm DC- 26.5GHz SMA Male to SMA Male



SM-SM-A050-3000 Flexible Cable Assembly 3000mm DC- 26.5GHz SMA Male to SMA Male



SM-SM-A050-5000 Flexible Cable Assembly 5000mm DC- 26.5GHz SMA Male to SMA Male



SM-SM-A050-10000 Flexible Cable Assembly 10000mm DC- 26.5GHz SMA Male to SMA Male



SM-SM-A080-200 Flexible Cable Assembly 200mm DC- 26.5GHz SMA Male to SMA Male



SM-SM-A080-300 Flexible Cable Assembly 300mm DC- 26.5GHz SMA Male to SMA Male



SM-SM-A080-500 Flexible Cable Assembly 500mm DC- 26.5GHz SMA Male to SMA Male



SM-SM-A080-1000 Flexible Cable Assembly 1000mm DC- 26.5GHz SMA Male to SMA Male



SM-SM-A080-1500 Flexible Cable Assembly 1500mm DC- 26.5GHz SMA Male to SMA Male



SM-SM-A080-2000 Flexible Cable Assembly 2000mm DC- 26.5GHz SMA Male to SMA Male



SM-SM-A080-3000 Flexible Cable Assembly 3000mm DC- 26.5GHz SMA Male to SMA Male



SM-SM-A080-5000 Flexible Cable Assembly 5000mm DC- 26.5GHz SMA Male to SMA Male



SM-SM-A080-10000 Flexible Cable Assembly 10000mm DC-26.5GHz SMA Male to SMA Male



SM-SM-A080-20000 Flexible Cable Assembly 20000mm DC-26.5GHz SMA Male to SMA Male



SM-SM-A100-100 Flexible Cable Assembly 100mm DC- 18GHz SMA Male to SMA Male



SM-SM-A100-200 Flexible Cable Assembly 200mm DC- 18GHz SMA Male to SMA Male



SM-SM-A100-300 Flexible Cable Assembly 300mm DC- 18GHz SMA Male to SMA Male



SM-SM-A100-500 Flexible Cable Assembly 500mm DC- 18GHz SMA Male to SMA Male



SM-SM-A100-1000 Flexible Cable Assembly 1000mm DC- 18GHz SMA Male to SMA Male



SM-SM-A100-1500 Flexible Cable Assembly 1500mm DC- 18GHz SMA Male to SMA Male



SM-SM-A100-2000 Flexible Cable Assembly 2000mm DC- 18GHz SMA Male to SMA Male



SM-SM-A100-3000 Flexible Cable Assembly 3000mm DC- 18GHz SMA Male to SMA Male



SM-SM-A100-5000 Flexible Cable Assembly 5000mm DC- 18GHz SMA Male to SMA Male



SM-SM-A100-10000 Flexible Cable Assembly 10000mm DC-18GHz SMA Male to SMA Male

Similar Products



LB-OH-159-15-C-NF Octave Horn Antenna 4-8GHz 15dB Gain N Type Female

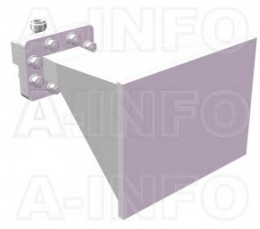

LB-OH-159-15-C-NFSPFO Octave Horn Antenna 4-8GHz 15dB Gain N Type Female



LB-OH-159-15-C-SF Octave Horn Antenna 4-8GHz 15dB Gain SMA Female



LB-OH-159-15-C-TF Octave Horn Antenna 4-8GHz 15dB Gain TNC Female

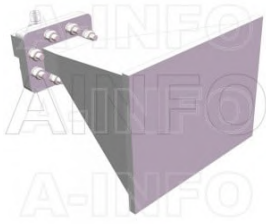

LB-OH-159-15-C-TFSP0 Octave Horn Antenna 4-8GHz 15dB Gain TNC Female

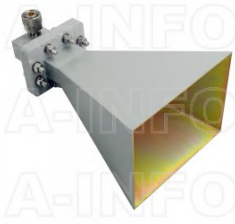

LB-OH-159-15-C-7 Octave Horn Antenna 4-8GHz 15dB Gain 7mm



LB-OH-159-15-C-7SPO Octave Horn Antenna 4-8GHz 15dB Gain 7mm



LB-OH-159-15-C-3.5F Octave Horn Antenna 4-8GHz 15dB Gain 3.5mm Female

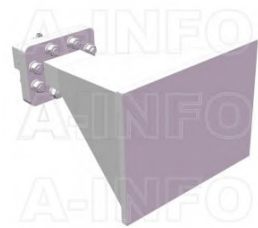

LB-OH-159-15-C-3.5FSPO Octave Horn Antenna 4-8GHz 15dB Gain 3.5mm Female

About this Datasheet

<ul style="list-style-type: none"> ● Product Information Product Link: https://www.ainfoinc.com/lb-oh-159-15-c-sfsp0-octave-horn-antenna-4-8-ghz-15db-gain-sma-female Data subject to change without notice. © A-INFO INC. 2024. All Rights Reserved 	<ul style="list-style-type: none"> ● Contact Us Address: 60 Tesla, Irvine, CA 92618, USA Website: www.ainfoinc.com Email: sales@ainfoinc.com 	<ul style="list-style-type: none"> ● Phone & Fax Phone: +1-949-639-9688 +1-949-639-9608 Fax: +1-949-639-9670
---	--	--