

LB-OH-112-20-C-SF Octave Horn Antenna 6-12GHz 20dB Gain SMA Female

Octave Horn Antenna Operating From 6GHz to 12GHz With a Nominal 20dB Gain With SMA Female Connector

Product Information

SKU	LB-OH-112-20-C-SF
-----	-------------------

Description

Octave horn antenna LB-OH-112-20-C-SF, operating from 6 to 12GHz with a nominal 20dB gain and low VSWR 1.5:1 with SMA Female output connector. The model LB-OH-112-20-C-SF has uniform gain through its frequency span, providing efficient performance characteristics and directionality. It can handle 50W continuously and 3000W peak power. Constructed of lightweight corrosion-resistant aluminum, the antenna will provide years of trouble-free indoor and outdoor service. This octave horn antenna is linearly polarized and ideally suited for EMI testing, direction finding, surveillance, antenna gain and pattern measurements and other applications.

Technical Specification

Electrical Specification		Interface	
Frequency, Min (GHz)	6	Output Type	Coaxial
Frequency, Max (GHz)	12	Connector	SMA
Gain, Typ (dBi)	20	Connector Gender	Female
Polarization	Linear	Mechanical Specification	
3dB Beamwidth, E-Plane, Min (Deg.)	11	Body Material	Al
3dB Beamwidth, E-Plane, Max (Deg.)	20	Finish	Chemical Conversion Coating, Gray Paint
3dB Beamwidth, H-Plane, Min (Deg.)	14	Size, W (mm)	172
3dB Beamwidth, H-Plane, Max (Deg.)	21	Size, H (mm)	128
Cross Pol. Isolation, Typ (dB)	35	Size, L (mm)	270
VSWR, Typ	1.5:1	Weight, (kg)	0.385
Impedance, (Ohm)	50		
Power Handling, CW, (W)	50		
Power Handling, Peak, (W)	3000		

Additional Information

Application	General Purpose Indoor & Outdoor, Fixed	Solution for	Gain Reference Antenna Measurement Far-field Measurement System Intergration
-------------	---	--------------	---

Outline Drawing

SMA-Female Output (P/N: LB-OH-112-20-C-SF)

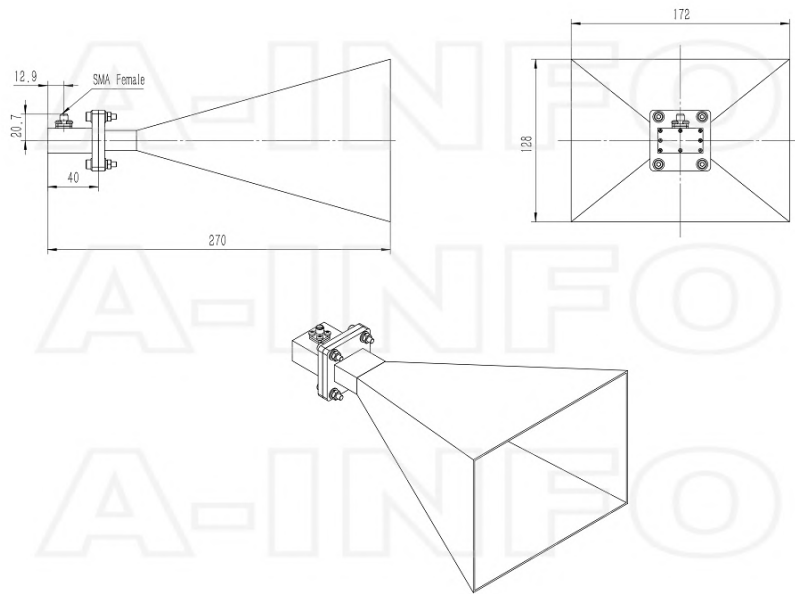

SMA-Female Output with Round Mounting Bracket (Option, P/N: LB-112-10-C-MB)

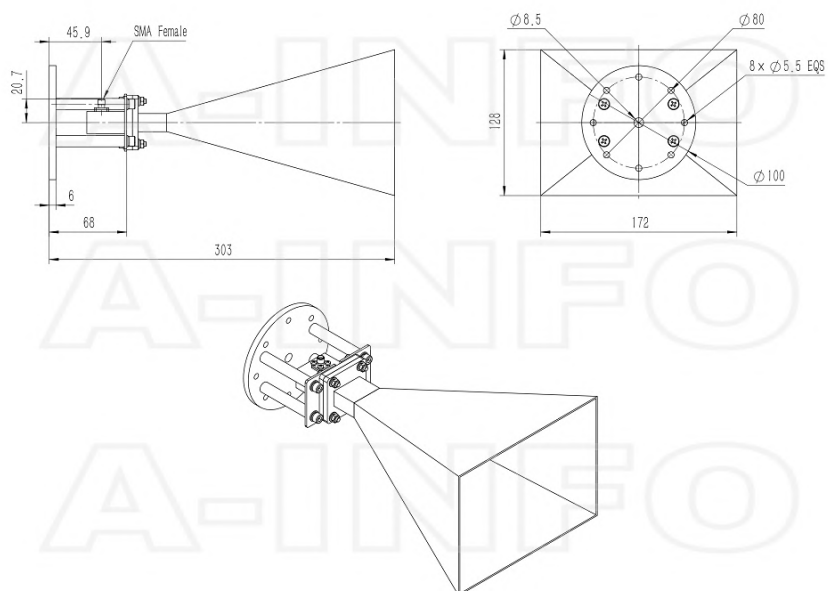

SMA-Female Output with L Type Mounting Bracket (Option, P/N:LB-112-10-C-MBL)

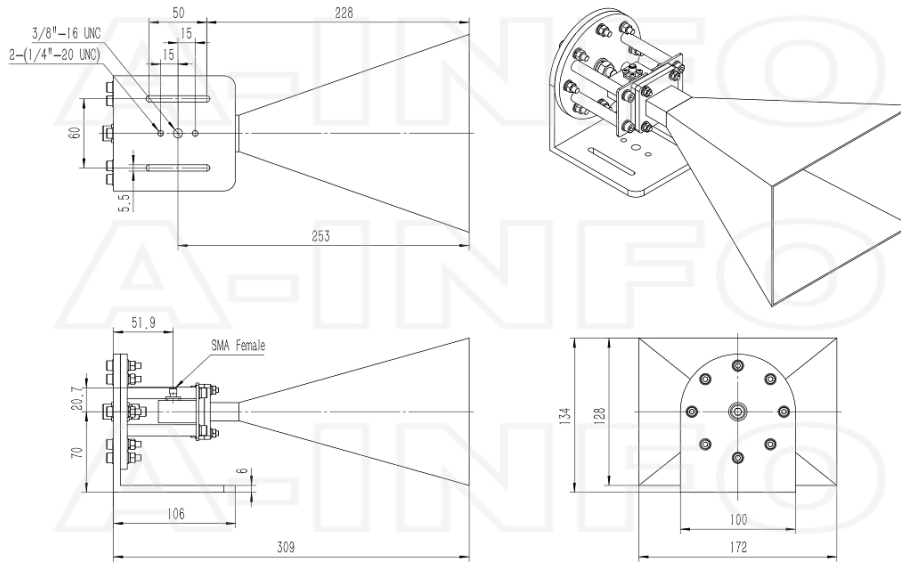

Typical Test Results

Gain

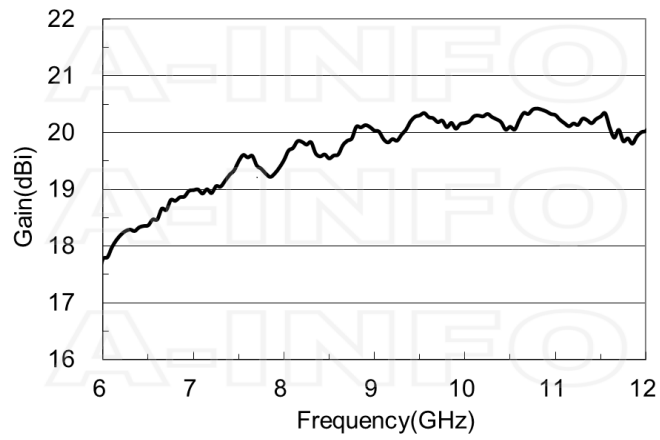

Antenna Factor

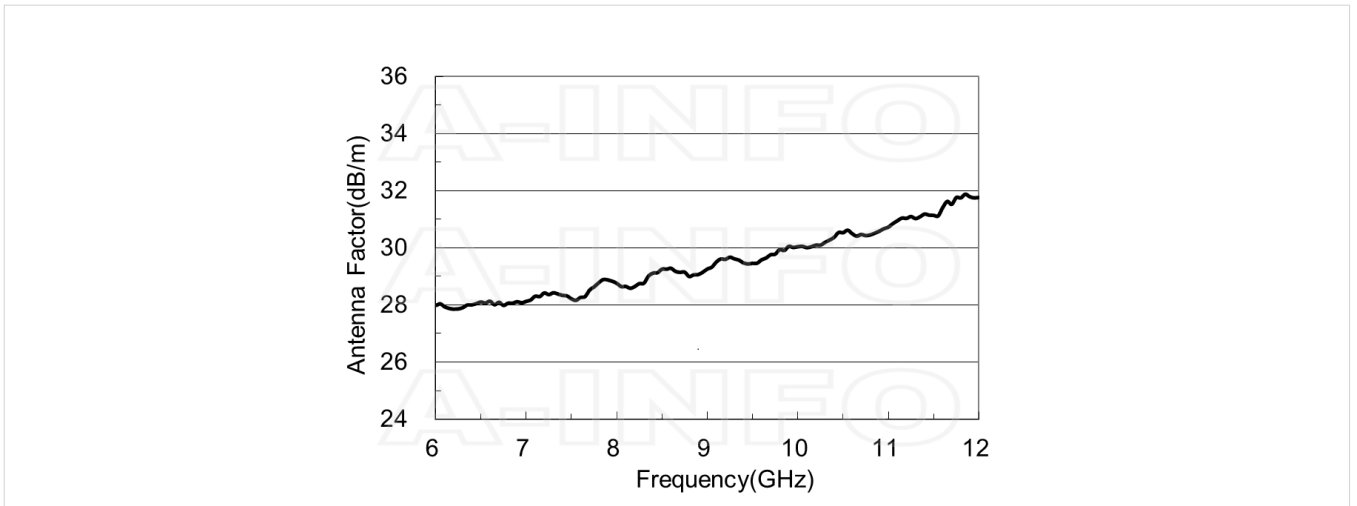

Antenna Factor (Table)

Frequency(GHz)	Gain(dBi)	AF(dB/m)
6.0	17.78	28.00
6.5	18.37	28.10
7.0	18.99	28.13
7.5	19.50	28.21
8.0	19.51	28.76
8.5	19.54	29.25
9.0	20.04	29.26
9.5	20.30	29.46
10.0	20.17	30.04
10.5	20.10	30.53
11.0	20.31	30.73
11.5	20.29	31.14
12.0	20.03	31.76

Cross Polarization Isolation

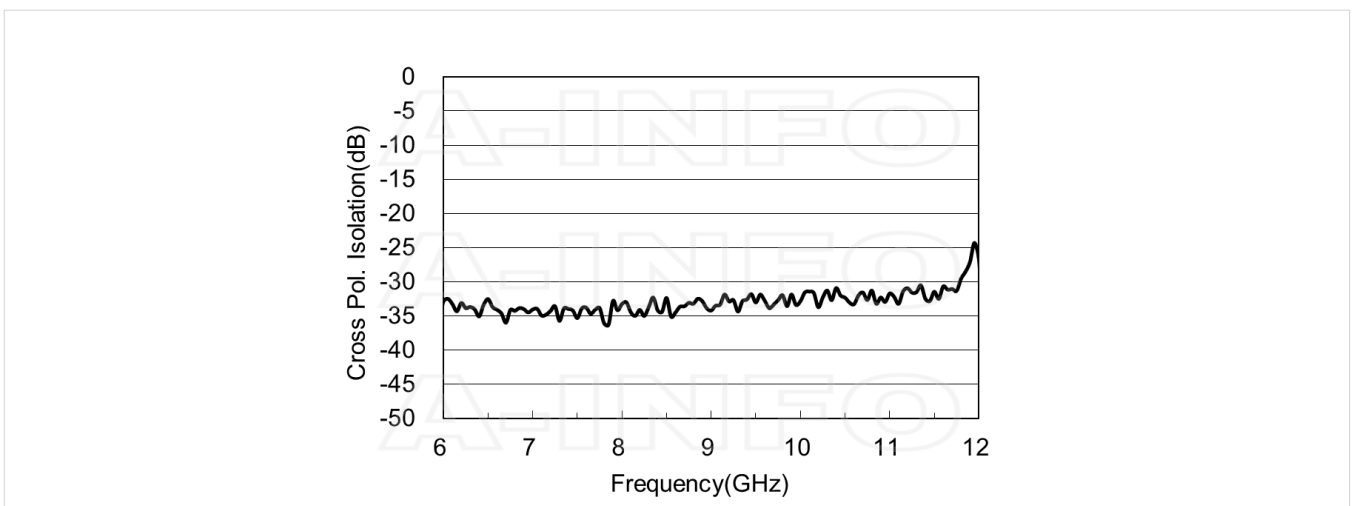

VSWR

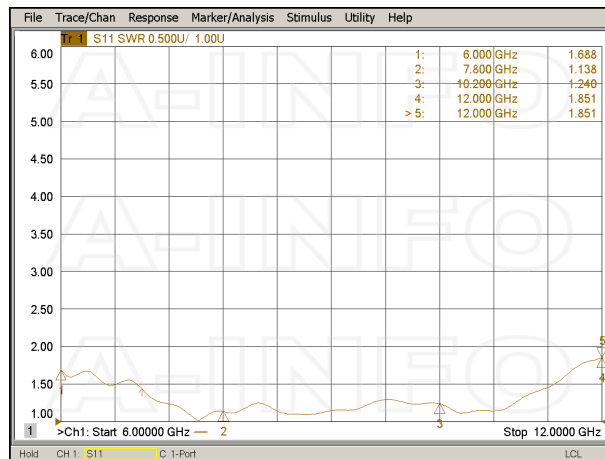

Beamwidth

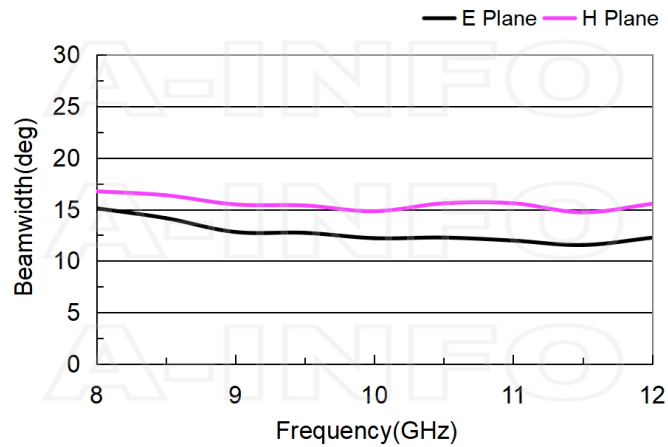

Pattern

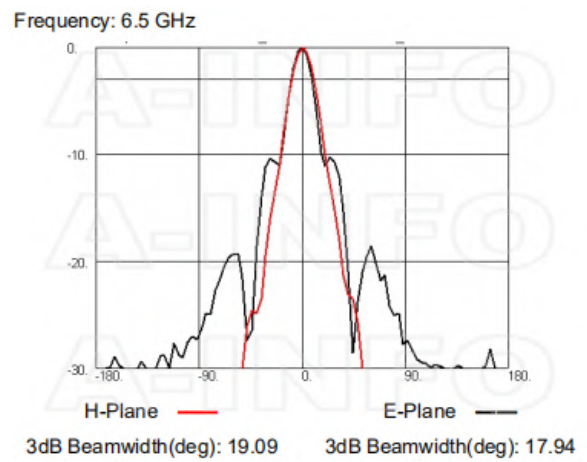
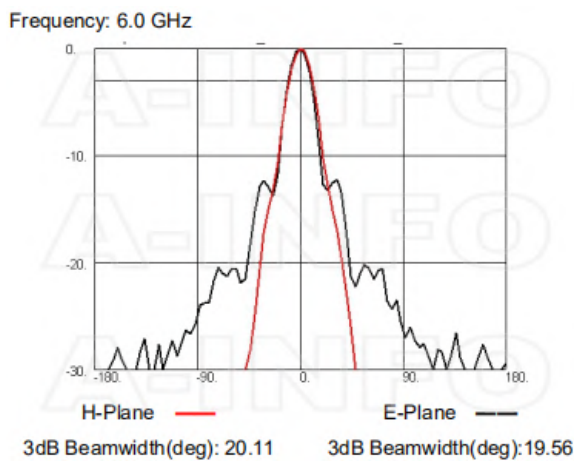

Frequency: 7.0 GHz

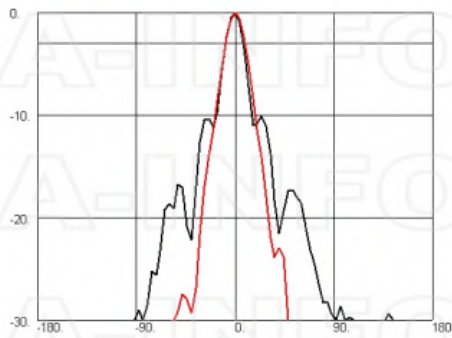

H-Plane — 3dB Beamwidth(deg): 17.68
E-Plane — 3dB Beamwidth(deg): 16.11

Frequency: 7.5 GHz

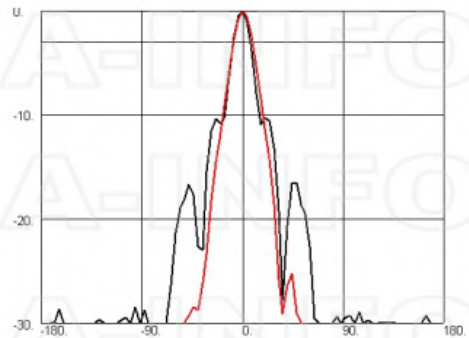

H-Plane — 3dB Beamwidth(deg): 17.03
E-Plane — 3dB Beamwidth(deg): 15.36

Frequency: 8.0 GHz

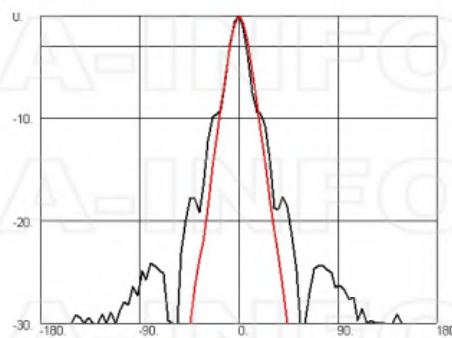

H-Plane — 3dB Beamwidth(deg): 16.76
E-Plane — 3dB Beamwidth(deg): 15.11

Frequency: 8.5 GHz

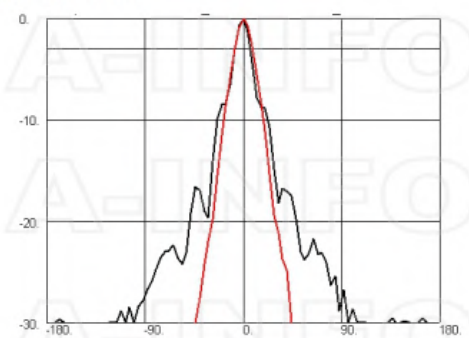

H-Plane — 3dB Beamwidth(deg): 16.37
E-Plane — 3dB Beamwidth(deg): 14.15

Frequency: 9.0 GHz

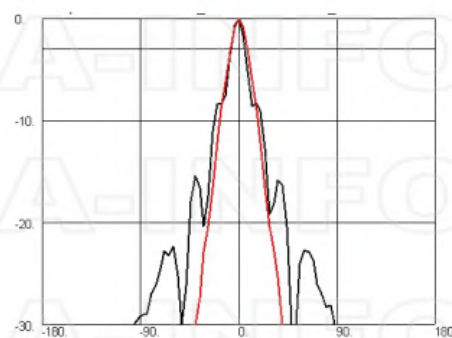

H-Plane — 3dB Beamwidth(deg): 15.48
E-Plane — 3dB Beamwidth(deg): 12.81

Frequency: 9.5 GHz

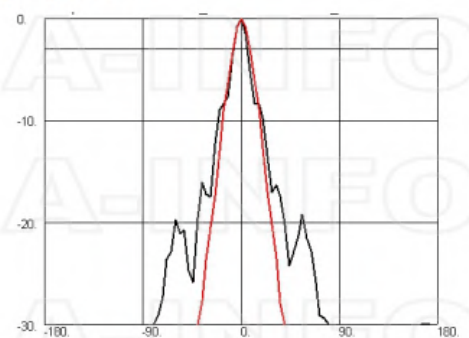

H-Plane — 3dB Beamwidth(deg): 15.38
E-Plane — 3dB Beamwidth(deg): 12.72

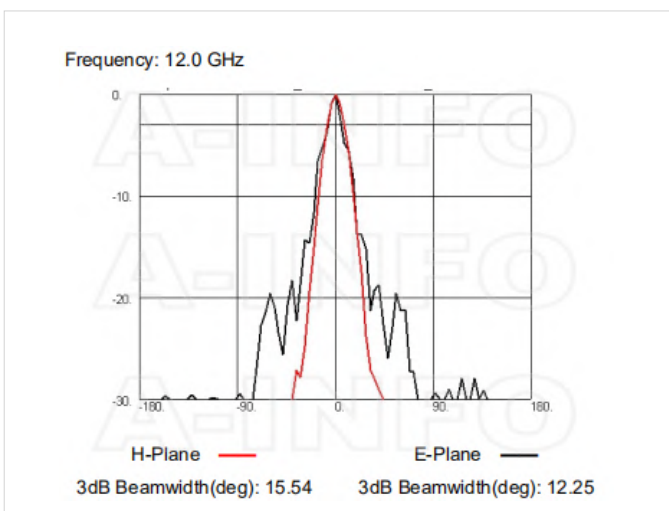
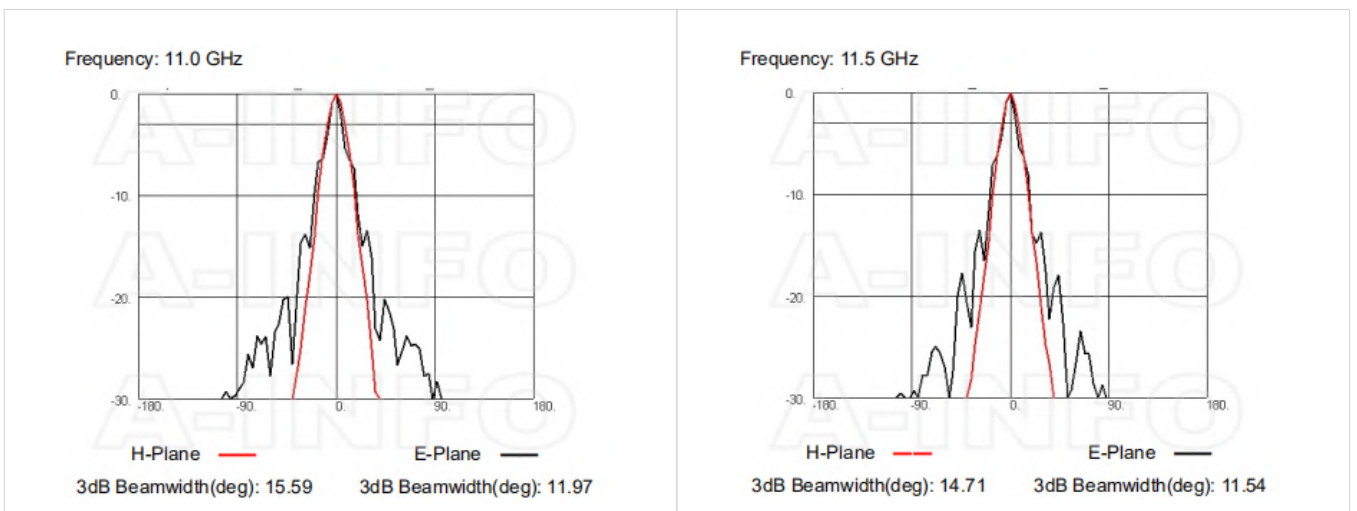
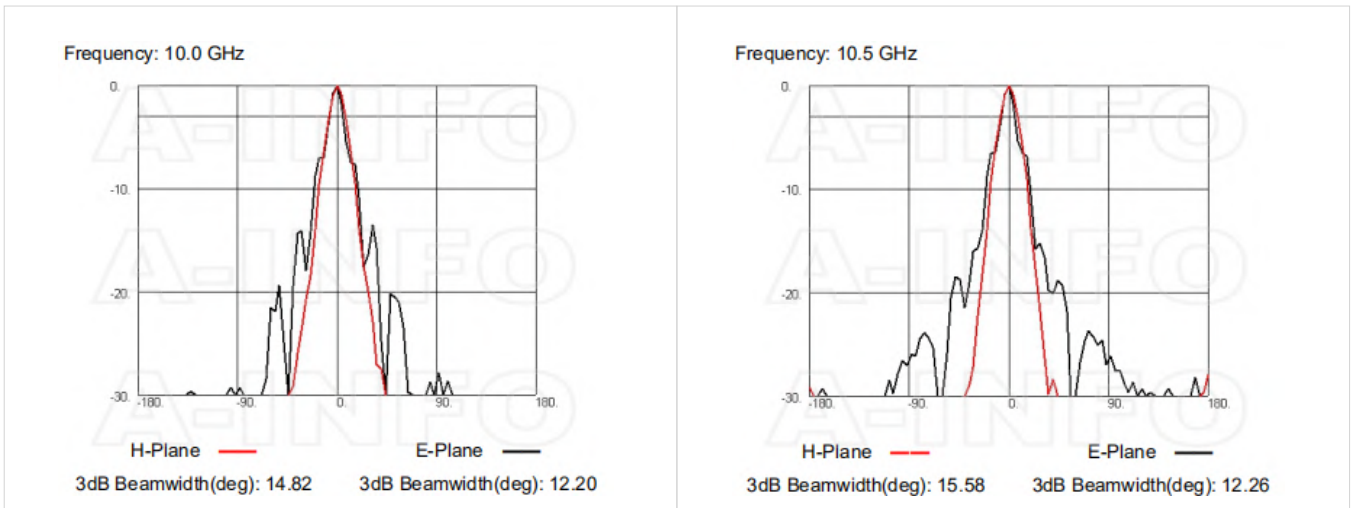

Related Products



LB-112-10-C-MB Round Type Mounting Bracket



LB-112-10-C-MBL L type mounting bracket



Tripod_15Kg Al Alloy Tripod



3033HL Wooden Tripod



3033QM Wooden Tripod Metalfree



Carrying Case_LB-112-20-C Al Alloy Carrying Case



SM-SM-A050-1000 Flexible Cable Assembly 1000mm DC- 26.5GHz SMA Male to SMA Male



SM-SM-A050-1500 Flexible Cable Assembly 1500mm DC- 26.5GHz SMA Male to SMA Male



SM-SM-A050-2000 Flexible Cable Assembly 2000mm DC- 26.5GHz SMA Male to SMA Male



SM-SM-A050-3000 Flexible Cable Assembly 3000mm DC- 26.5GHz SMA Male to SMA Male



SM-SM-A050-5000 Flexible Cable Assembly 5000mm DC- 26.5GHz SMA Male to SMA Male



SM-SM-A050-10000 Flexible Cable Assembly 10000mm DC- 26.5GHz SMA Male to SMA Male



SM-SM-A080-200 Flexible Cable Assembly 200mm DC- 26.5GHz SMA Male to SMA Male



SM-SM-A080-300 Flexible Cable Assembly 300mm DC- 26.5GHz SMA Male to SMA Male



SM-SM-A080-500 Flexible Cable Assembly 500mm DC- 26.5GHz SMA Male to SMA Male



SM-SM-A080-1000 Flexible Cable Assembly 1000mm DC- 26.5GHz SMA Male to SMA Male



SM-SM-A080-1500 Flexible Cable Assembly 1500mm DC- 26.5GHz SMA Male to SMA Male



SM-SM-A080-2000 Flexible Cable Assembly 2000mm DC- 26.5GHz SMA Male to SMA Male



SM-SM-A080-3000 Flexible Cable Assembly 3000mm DC- 26.5GHz SMA Male to SMA Male



SM-SM-A080-5000 Flexible Cable Assembly 5000mm DC- 26.5GHz SMA Male to SMA Male



SM-SM-A080-10000 Flexible Cable Assembly 10000mm DC- 26.5GHz SMA Male to SMA Male



SM-SM-A080-20000 Flexible Cable Assembly 20000mm DC- 26.5GHz SMA Male to SMA Male



SM-SM-A100-100 Flexible Cable Assembly 100mm DC- 18GHz SMA Male to SMA Male



SM-SM-A100-200 Flexible Cable Assembly 200mm DC- 18GHz SMA Male to SMA Male



SM-SM-A100-300 Flexible Cable Assembly 300mm DC- 18GHz SMA Male to SMA Male



SM-SM-A100-500 Flexible Cable Assembly 500mm DC- 18GHz SMA Male to SMA Male



SM-SM-A100-1000 Flexible Cable Assembly 1000mm DC- 18GHz SMA Male to SMA Male



SM-SM-A100-1500 Flexible Cable Assembly 1500mm DC- 18GHz SMA Male to SMA Male



SM-SM-A100-2000 Flexible Cable Assembly 2000mm DC- 18GHz SMA Male to SMA Male



SM-SM-A100-3000 Flexible Cable Assembly 3000mm DC- 18GHz SMA Male to SMA Male



SM-SM-A100-5000 Flexible Cable Assembly 5000mm DC- 18GHz SMA Male to SMA Male



SM-SM-A100-10000 Flexible Cable Assembly 10000mm DC- 18GHz SMA Male to SMA Male

Similar Products

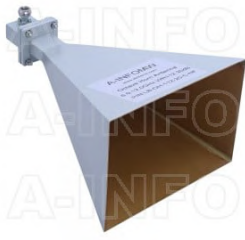

LB-OH-112-20-C-NF Octave Horn Antenna 6-12GHz 20dB Gain N Type Female



LB-OH-112-20-C-NFSPO Octave Horn Antenna 6-12GHz 20dB Gain N Type Female

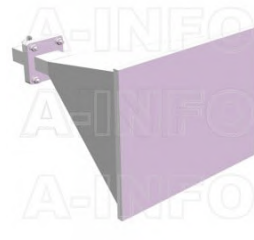

LB-OH-112-20-C-SFSPO Octave Horn Antenna 6-12GHz 20dB Gain SMA Female



LB-OH-112-20-C-TF Octave Horn Antenna 6-12GHz 20dB Gain TNC Female

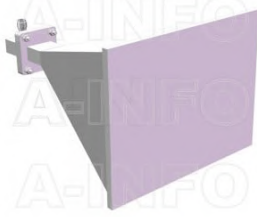

LB-OH-112-20-C-TFSPO Octave Horn Antenna 6-12GHz 20dB Gain TNC Female



LB-OH-112-20-C-7 Octave Horn Antenna 6-12GHz 20dB Gain 7mm



LB-OH-112-20-C-7SPO Octave Horn Antenna 6-12GHz 20dB Gain 7mm

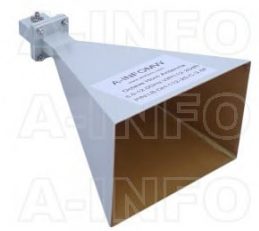

LB-OH-112-20-C-3.5F Octave Horn Antenna 6-12GHz 20dB Gain 3.5mm Female

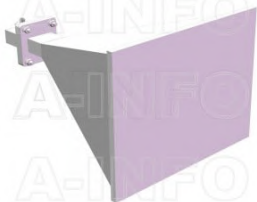

LB-OH-112-20-C-3.5FSPO Octave Horn Antenna 6-12GHz 20dB Gain 3.5mm Female

About this Datasheet

- Product Information

Product Link:
<https://www.ainfoinc.com/lb-oh-112-20-c-sf-octave-horn-antenna-6-12-ghz-20db-gain-sma-female>
 Data subject to change without notice.
 © A-INFO INC. 2024. All Rights Reserved

- Contact Us

Address:
 60 Tesla, Irvine, CA 92618, USA

Website:
www.ainfoinc.com

Email:
sales@ainfoinc.com

- Phone & Fax

Phone:
 +1-949-639-9688
 +1-949-639-9608

Fax:
 +1-949-639-9670