

LB-OH-112-20-C-7 Octave Horn Antenna 6-12GHz 20dB Gain 7mm

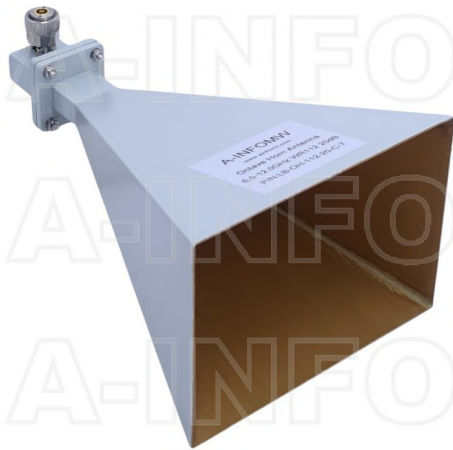

Octave Horn Antenna Operating From 6GHz to 12GHz With a Nominal 20dB Gain With 7mm Connector

Product Information

SKU	LB-OH-112-20-C-7
-----	------------------

Description

Octave horn antenna LB-OH-112-20-C-7, operating from 6 to 12Hz with a nominal 20dB gain and low VSWR 1.5:1 with 7mm output connector. The model LB-OH-112-20-C-7 has uniform gain through its frequency span, providing efficient performance characteristics and directionality. It can handle 150W continuously and 3000W peak power. Constructed of lightweight corrosion-resistant aluminum, the antenna will provide years of trouble-free indoor and outdoor service. This octave horn antenna is linearly polarized and ideally suited for EMI testing, direction finding, surveillance, antenna gain and pattern measurements and other applications.

Technical Specification

Electrical Specification		Interface	
Frequency, Min (GHz)	6	Output Type	Coaxial
Frequency, Max (GHz)	12	Connector	7mm
Gain, Typ (dBi)	20	Connector Gender	N/A
Polarization	Linear	Mechanical Specification	
3dB Beamwidth, E-Plane, Min (Deg.)	11	Body Material	Al
3dB Beamwidth, E-Plane, Max (Deg.)	20	Finish	Chemical Conversion Coating, Gray Paint
3dB Beamwidth, H-Plane, Min (Deg.)	14	Size, W (mm)	172
3dB Beamwidth, H-Plane, Max (Deg.)	21	Size, H (mm)	128
Cross Pol. Isolation, Typ (dB)	35	Size, L (mm)	270
VSWR, Typ	1.5:1	Weight, (kg)	0.424
Impedance, (Ohm)	50		
Power Handling, CW, (W)	150		
Power Handling, Peak, (W)	3000		

Additional Information

Application	General Purpose Indoor & Outdoor, Fixed	Solution for	Gain Reference Antenna Measurement Far-field Measurement System Intergration
-------------	---	--------------	---

Outline Drawing

7mm Output (P/N: LB-OH-112-20-C-7)

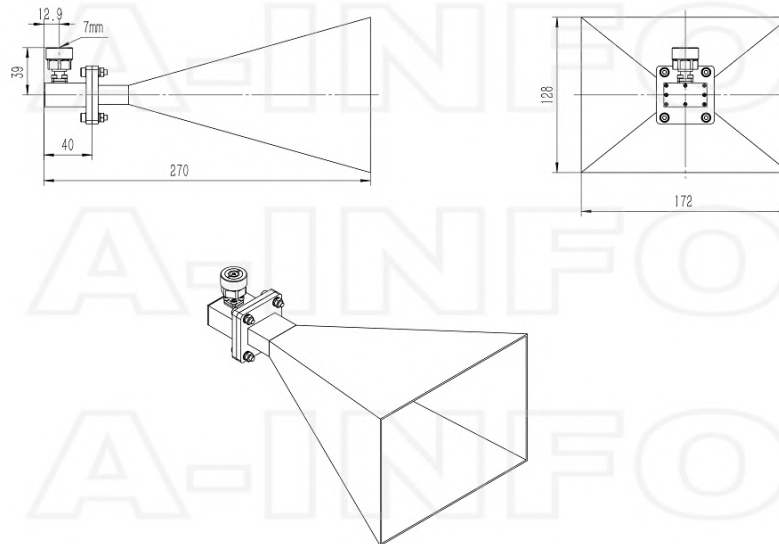

7mm Output with Round Mounting Bracket (Option, P/N: LB-112-10-C-MB)

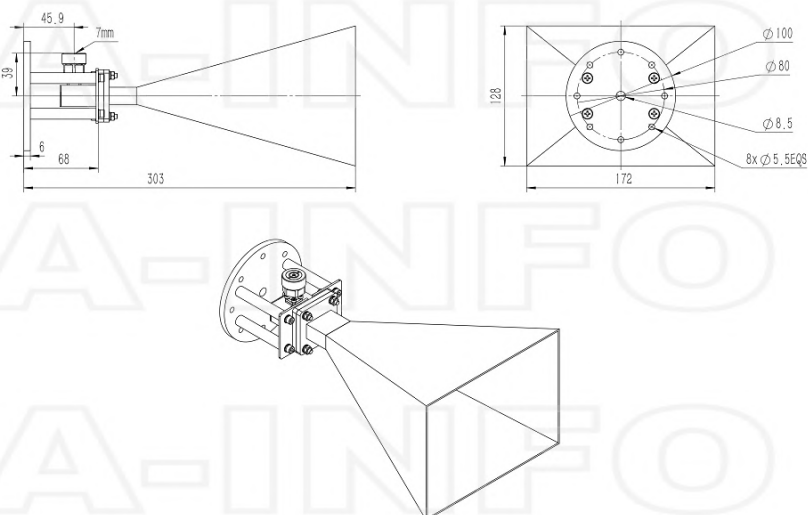

7mm Output with L Type Mounting Bracket (Option, P/N:LB-112-10-C-MBL)

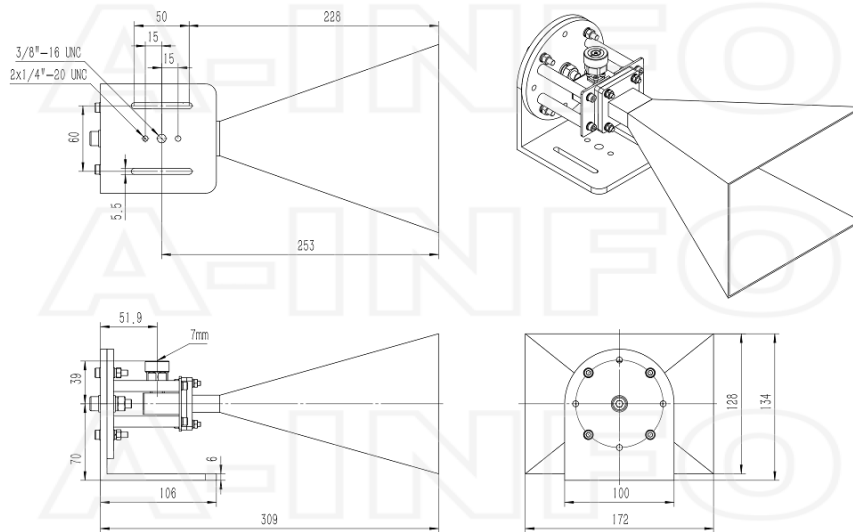

Typical Test Results

Gain

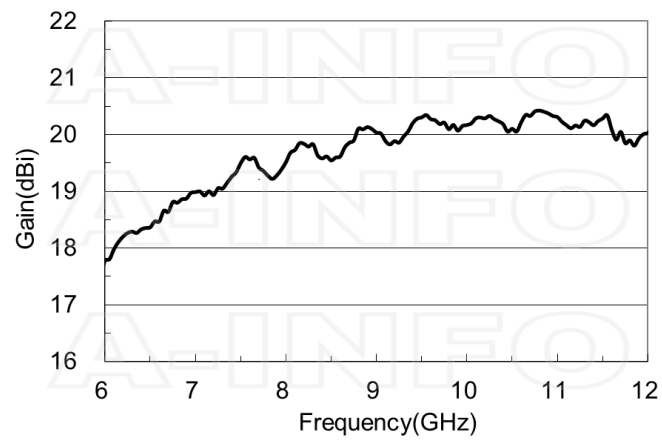

Antenna Factor

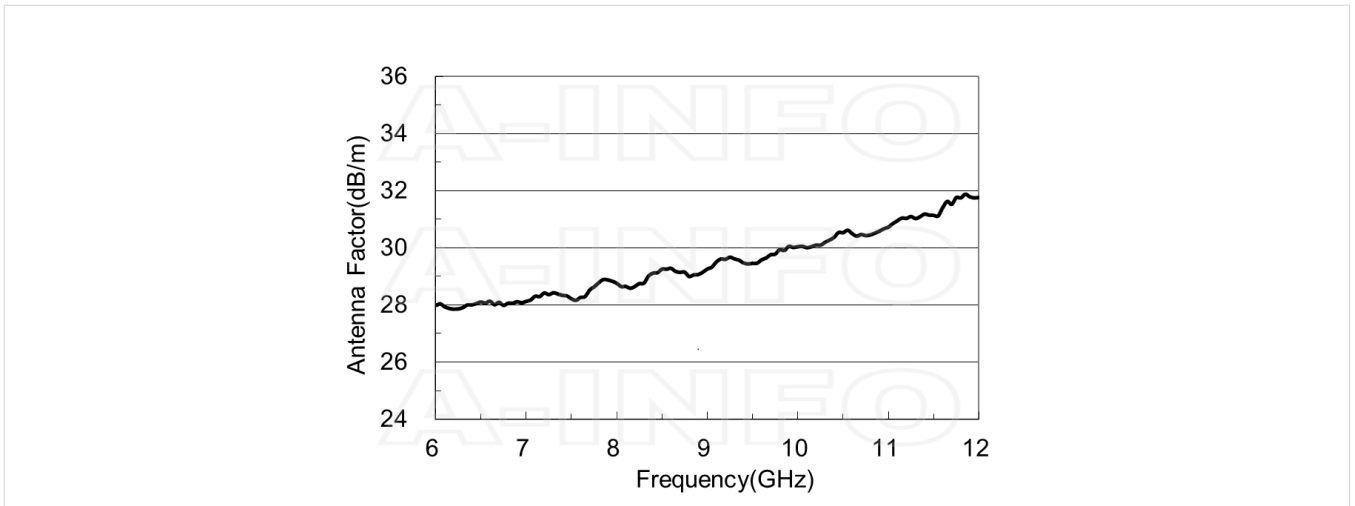

Antenna Factor (Table)

Frequency(GHz)	Gain(dBi)	AF(dB/m)
6.0	17.78	28.00
6.5	18.37	28.10
7.0	18.99	28.13
7.5	19.50	28.21
8.0	19.51	28.76
8.5	19.54	29.25
9.0	20.04	29.26
9.5	20.30	29.46
10.0	20.17	30.04
10.5	20.10	30.53
11.0	20.31	30.73
11.5	20.29	31.14
12.0	20.03	31.76

Cross Polarization Isolation

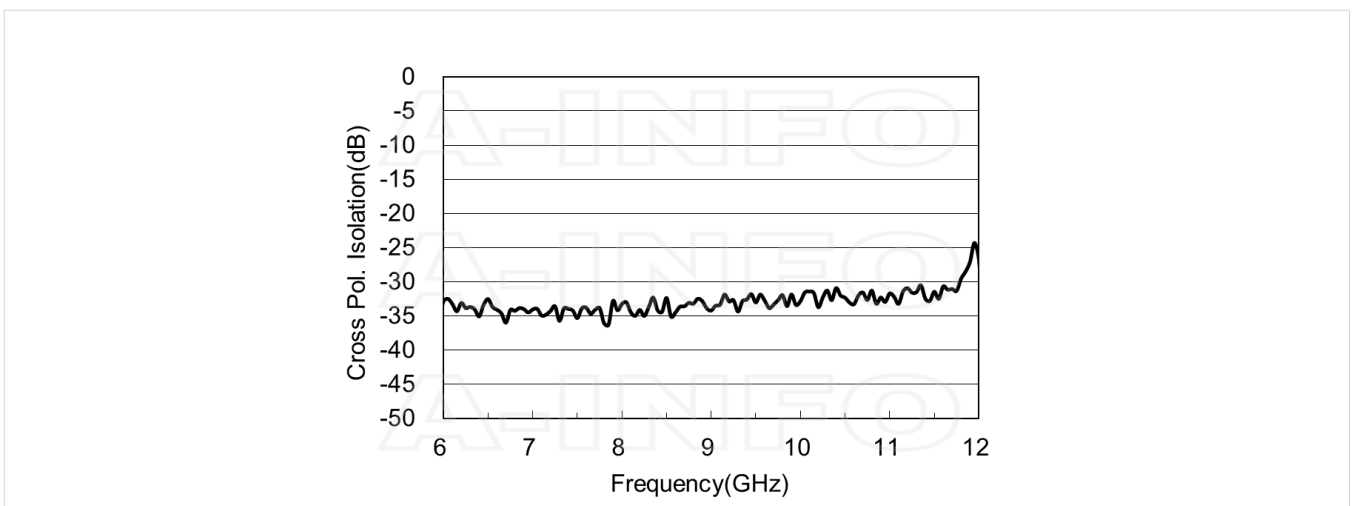

VSWR

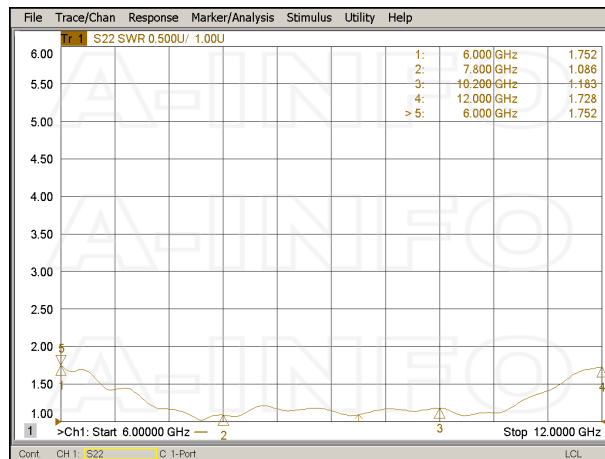

Beamwidth

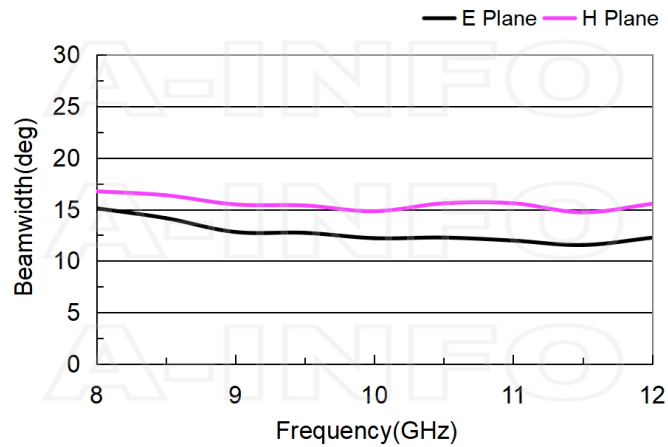

Pattern

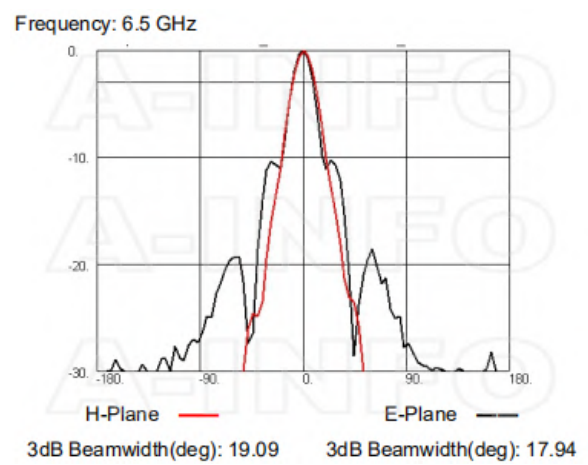
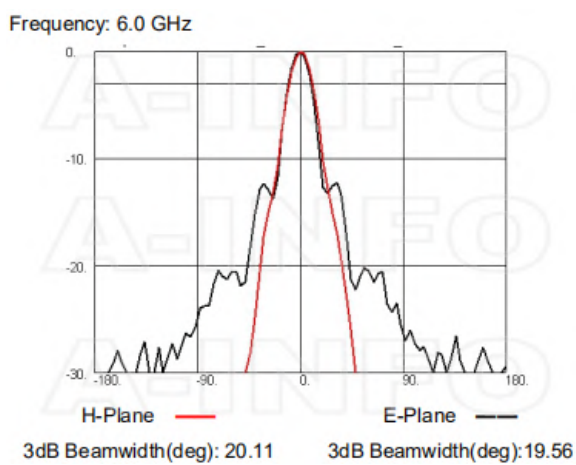

Frequency: 7.0 GHz

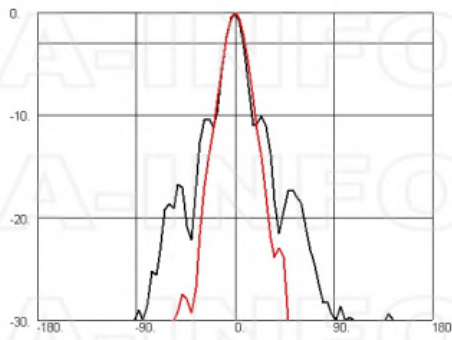

H-Plane — 3dB Beamwidth(deg): 17.68
E-Plane — 3dB Beamwidth(deg): 16.11

Frequency: 7.5 GHz

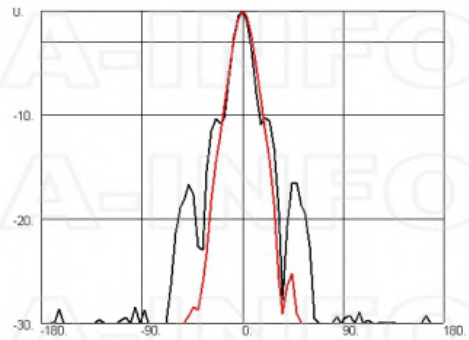

H-Plane — 3dB Beamwidth(deg): 17.03
E-Plane — 3dB Beamwidth(deg): 15.36

Frequency: 8.0 GHz

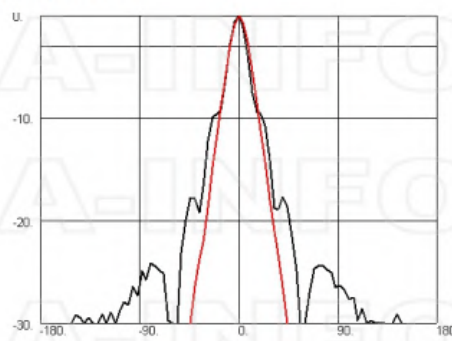

H-Plane — 3dB Beamwidth(deg): 16.76
E-Plane — 3dB Beamwidth(deg): 15.11

Frequency: 8.5 GHz

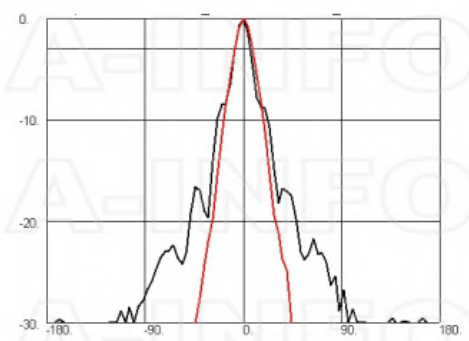

H-Plane — 3dB Beamwidth(deg): 16.37
E-Plane — 3dB Beamwidth(deg): 14.15

Frequency: 9.0 GHz

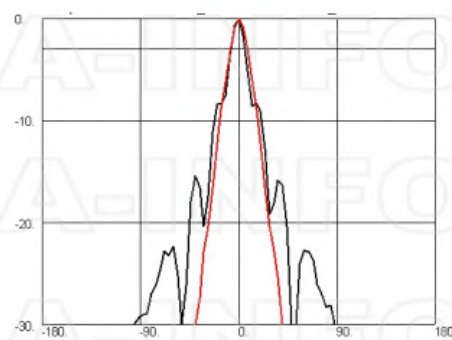

H-Plane — 3dB Beamwidth(deg): 15.48
E-Plane — 3dB Beamwidth(deg): 12.81

Frequency: 9.5 GHz

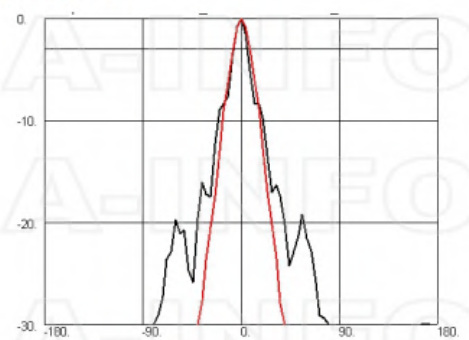

H-Plane — 3dB Beamwidth(deg): 15.38
E-Plane — 3dB Beamwidth(deg): 12.72

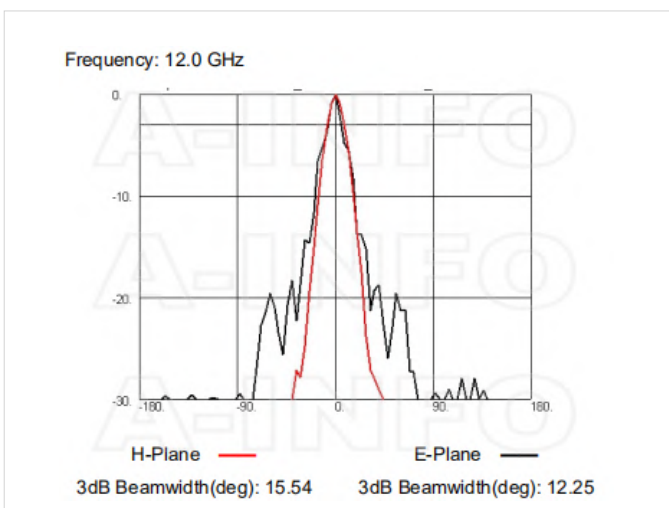
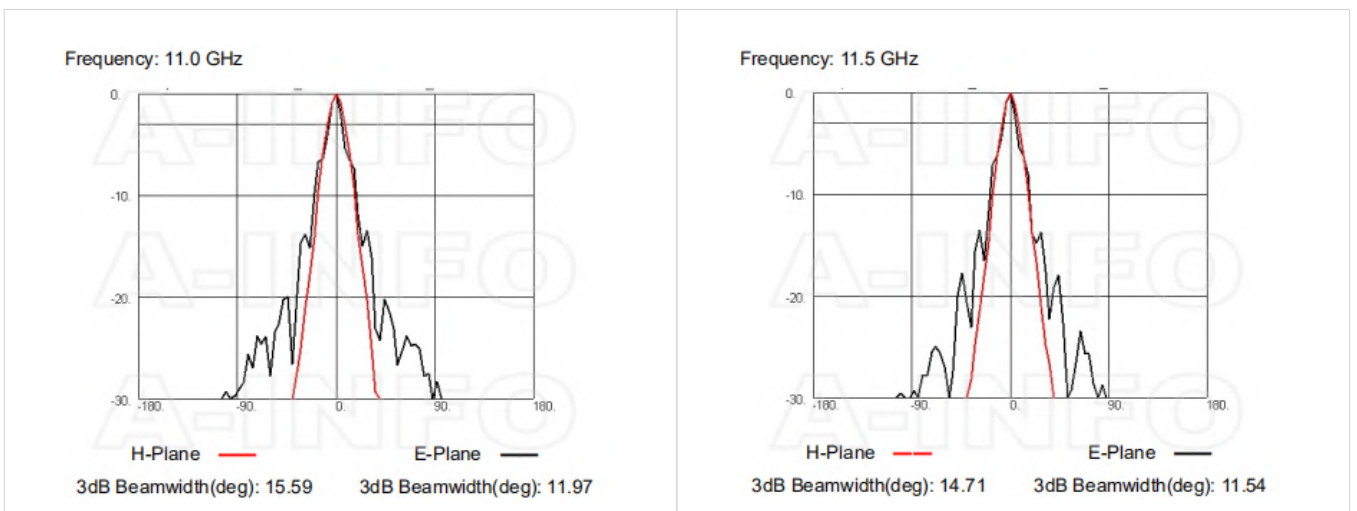
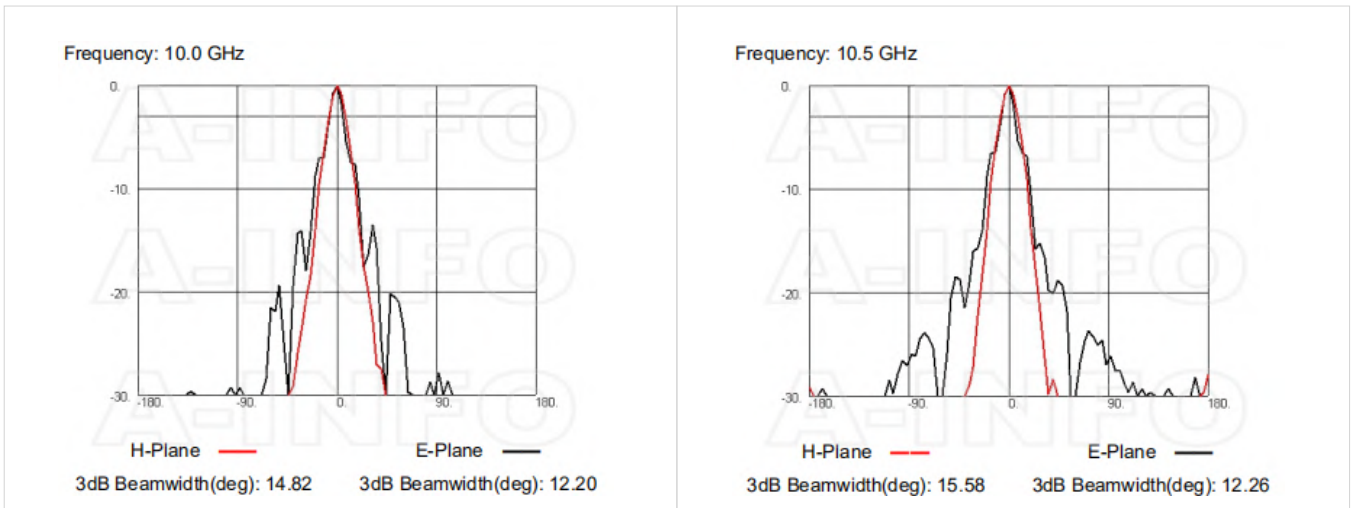

Related Products



LB-112-10-C-MB Round Type Mounting Bracket



LB-112-10-C-MBL L type mounting bracket



Tripod_15Kg Al Alloy Tripod



3033HL Wooden Tripod



3033QM Wooden Tripod Metalfree



Carrying Case_LB-112-20-C Al Alloy Carrying Case

Similar Products

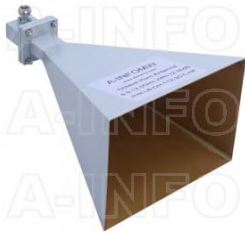

LB-OH-112-20-C-NF Octave Horn Antenna 6-12GHz 20dB Gain N Type Female



LB-OH-112-20-C-NFSP0 Octave Horn Antenna 6-12GHz 20dB Gain N Type Female

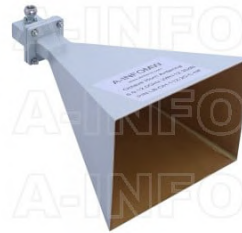

LB-OH-112-20-C-SF Octave Horn Antenna 6-12GHz 20dB Gain SMA Female

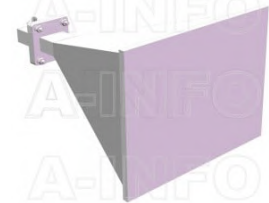

LB-OH-112-20-C-SFSP0 Octave Horn Antenna 6-12GHz 20dB Gain SMA Female



LB-OH-112-20-C-TF Octave Horn Antenna 6-12GHz 20dB Gain TNC Female

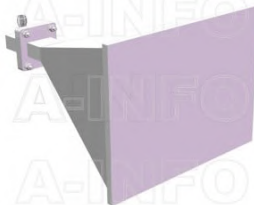

LB-OH-112-20-C-TFSP0 Octave Horn Antenna 6-12GHz 20dB Gain TNC Female

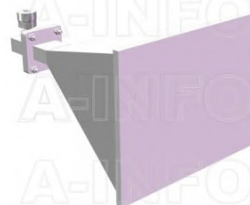

LB-OH-112-20-C-7SPO Octave Horn Antenna 6-12GHz 20dB Gain 7mm

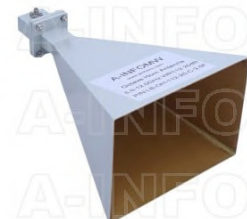

LB-OH-112-20-C-3.5F Octave Horn Antenna 6-12GHz 20dB Gain 3.5mm Female

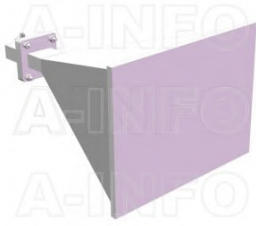

LB-OH-112-20-C-3.5FSPO Octave
Horn Antenna 6-12GHz 20dB
Gain 3.5mm Female

About this Datasheet

<ul style="list-style-type: none"> ● Product Information Product Link: https://www.ainfoinc.com/lb-oh-112-20-c-7-octave-horn-antenna-6-12-ghz-20db-gain-7mm Data subject to change without notice. © A-INFO INC. 2024. All Rights Reserved 	<ul style="list-style-type: none"> ● Contact Us Address: 60 Tesla, Irvine, CA 92618, USA Website: www.ainfoinc.com Email: sales@ainfoinc.com 	<ul style="list-style-type: none"> ● Phone & Fax Phone: +1-949-639-9688 +1-949-639-9608 Fax: +1-949-639-9670
---	--	---