

LB-75180-10-C-NFSPO Multi Octave Horn Antenna 7.5-18GHz 10dB Gain
N Type Female

Multi Octave Horn Antenna Operating From 7.5GHz to 18GHz With a
Nominal 10dB Gain With N Type Female Connector

Product Information

SKU	LB-75180-10-C-NFSPO
-----	---------------------

Description

Multi octave horn antenna LB-75180-10-C-NFSPO, operating from 7.5 to 18GHz with a nominal 10dB gain and low VSWR 1.5:1 with N Type Female output connector. The model LB-75180-10-C-NFSPO has uniform gain through its frequency span, providing efficient performance characteristics and directionality. It can handle 150W continuously and 3000W peak power. Constructed of lightweight corrosion-resistant aluminum, the horn comes with a specially designed weatherproof radome which provides excellent protection against the rain and dust but has very little loss across the full operating frequency band. This multi octave horn antenna is linearly polarized and ideally suited for EMI testing, direction finding, surveillance, antenna gain and pattern measurements and other applications.

Technical Specification

Electrical Specification	
Frequency, Min (GHz)	7.5
Frequency, Max (GHz)	18
Waveguide Type	Double Ridge
Waveguide Size EIA WRD	WRD750
Gain, Typ (dBi)	10
Polarization	Linear
3dB Beamwidth, E-Plane, Min (Deg.)	26
3dB Beamwidth, E-Plane, Max (Deg.)	56
3dB Beamwidth, H-Plane, Min (Deg.)	26
3dB Beamwidth, H-Plane, Max (Deg.)	57
Cross Pol. Isolation, Typ (dB)	35
VSWR, Typ	1.5:1
Impedance, (Ohm)	50
Power Handling, CW, (W)	150
Power Handling, Peak, (W)	3000

Interface	
Output Type	Coaxial
Connector	N Type
Connector Gender	Female
Mechanical Specification	
Figure	C Type
Body Material	Al
Finish	Nickel Plated and Passivation, Gray Paint
Size, W (mm)	56
Size, H (mm)	56.6
Size, L (mm)	99.7
Weight, (kg)	0.3

Additional Information

Application	Outdoor, Waterproof and Dustproof, Fixed
-------------	--

Solution for	Gain Reference Antenna Measurement Far-field Measurement System Intergration
--------------	---

Outline Drawing

N-Female Output with Radome (Option, P/N: LB-75180-10-C-NFSPO, Outdoor Application)

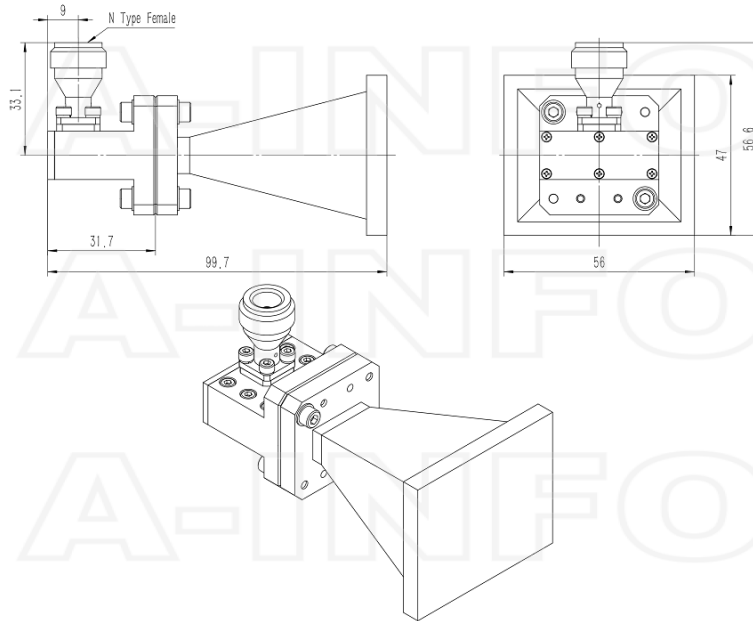

N-Female Output with Round Mounting Bracket & Radome (Option, P/N: LB-75180-10-C-MB & LB-75180-10-C-NFSPO, Outdoor Application)

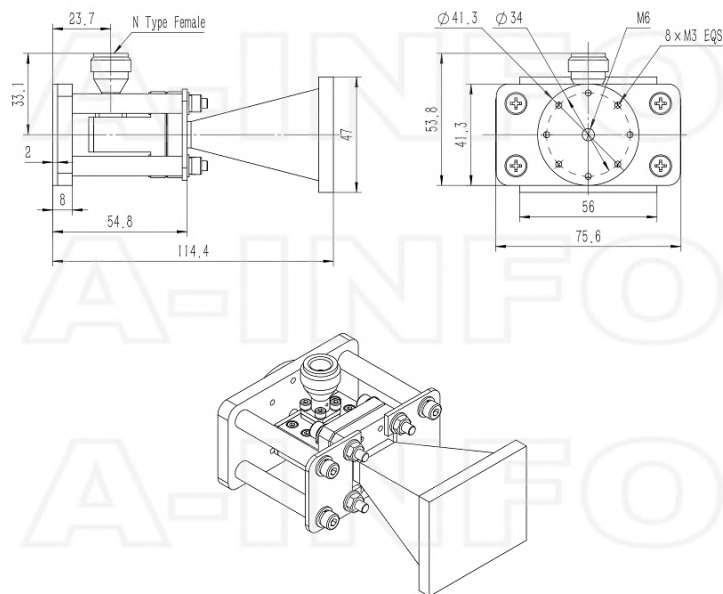

N-Female Output with L Type Mounting Bracket & Radome (Option, P/N: LB-75180-10-C-MBL & LB-75180-10-C-NFSPO, Outdoor Application)

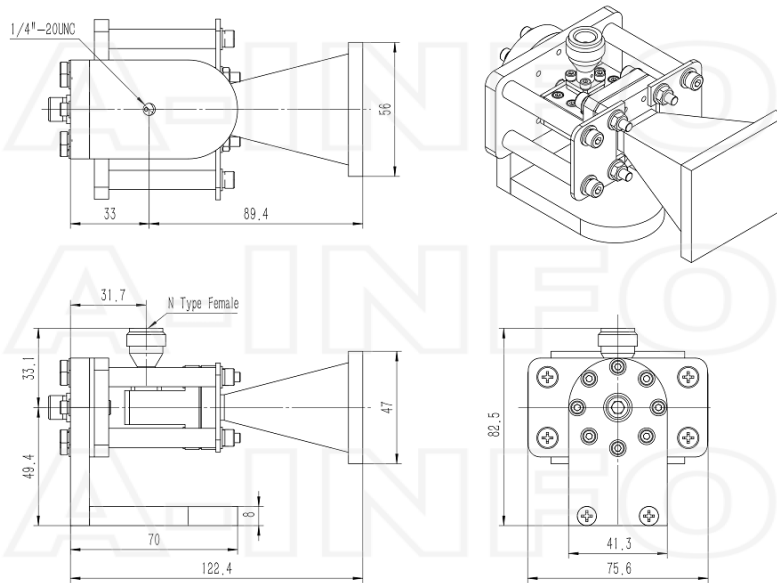

Typical Test Results

Gain

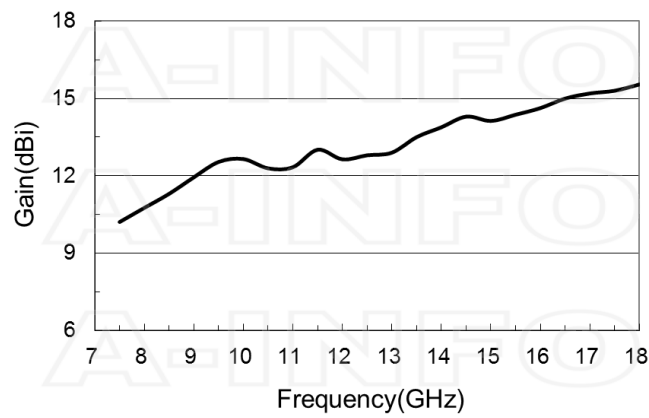

Antenna Factor

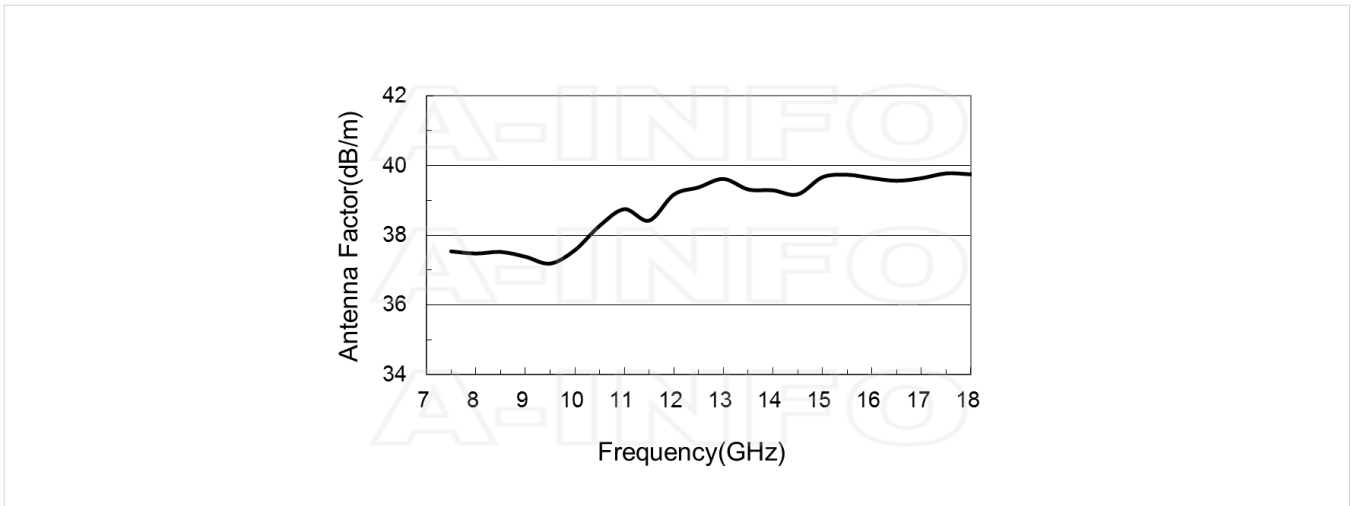

Antenna Factor (Table)

Frequency(GHz)	Gain(dBi)	AF(dB/m)
7.5	10.21	37.50
8.0	10.76	37.51
9.0	11.95	37.35
10.0	12.65	37.56
11.0	12.34	38.70
12.0	12.64	39.15
13.0	12.90	39.59
14.0	13.89	39.25
15.0	14.13	39.60
16.0	14.63	39.66
17.0	15.20	39.62
18.0	15.55	39.77

Cross Polarization Isolation

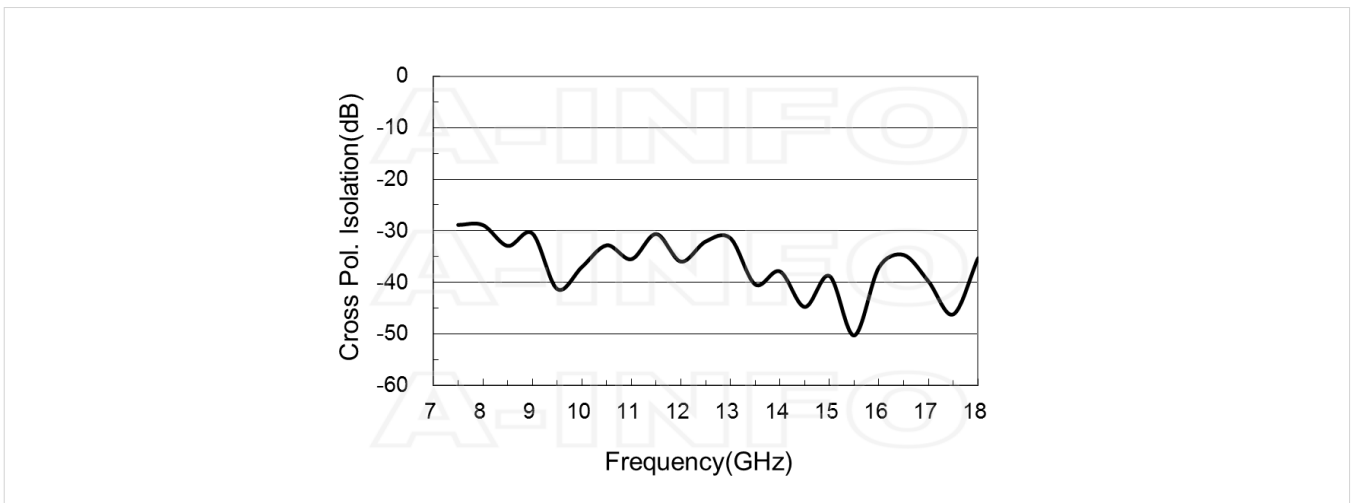

VSWR

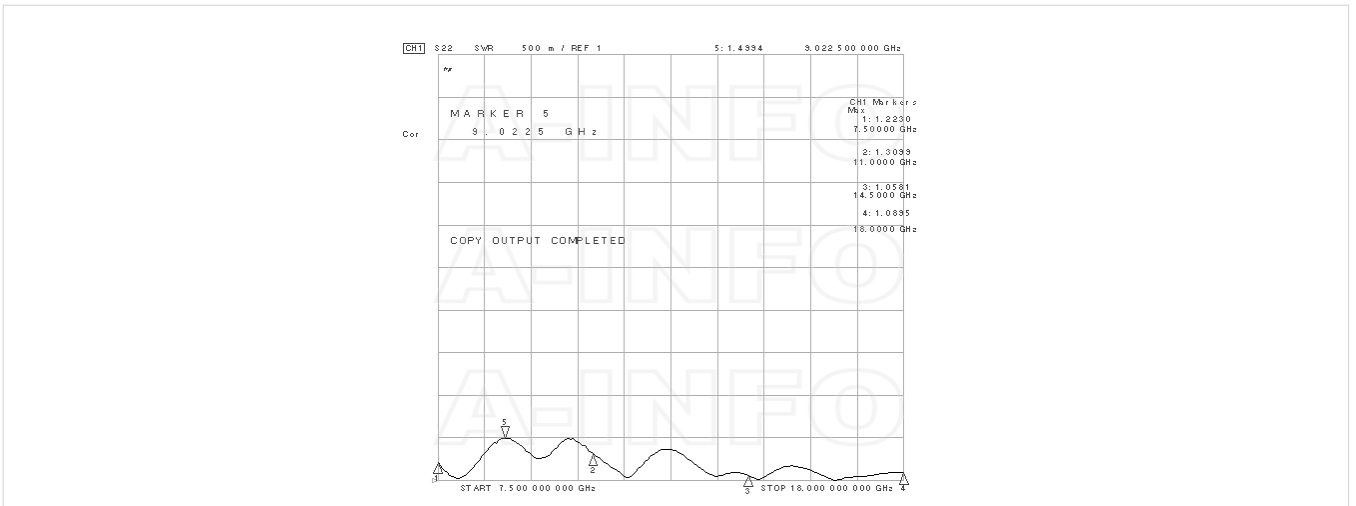

Beamwidth

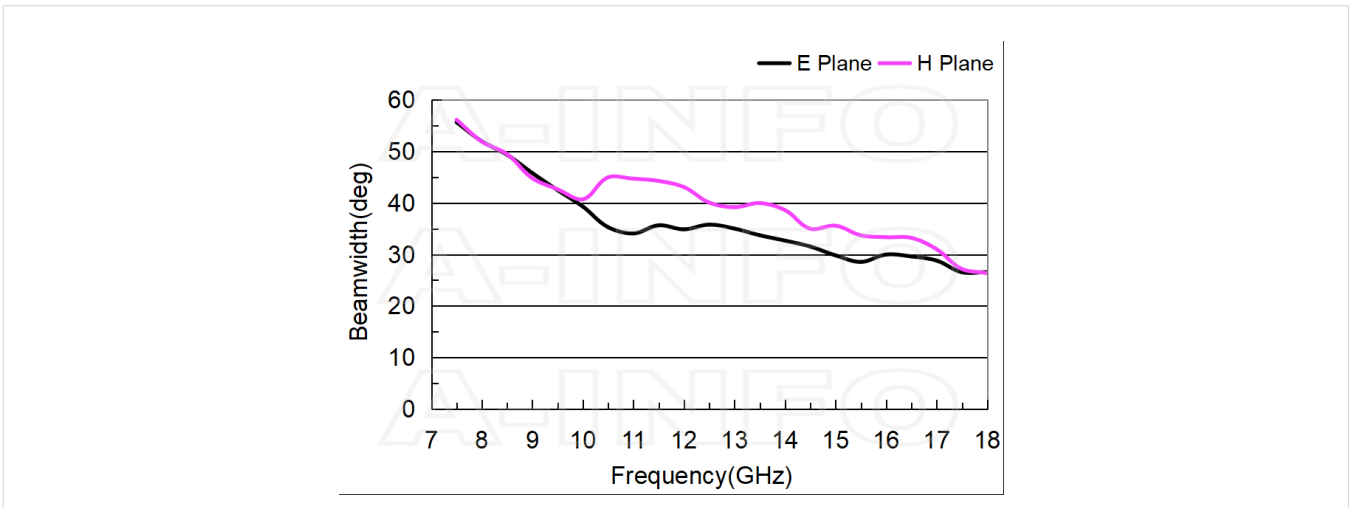

Pattern

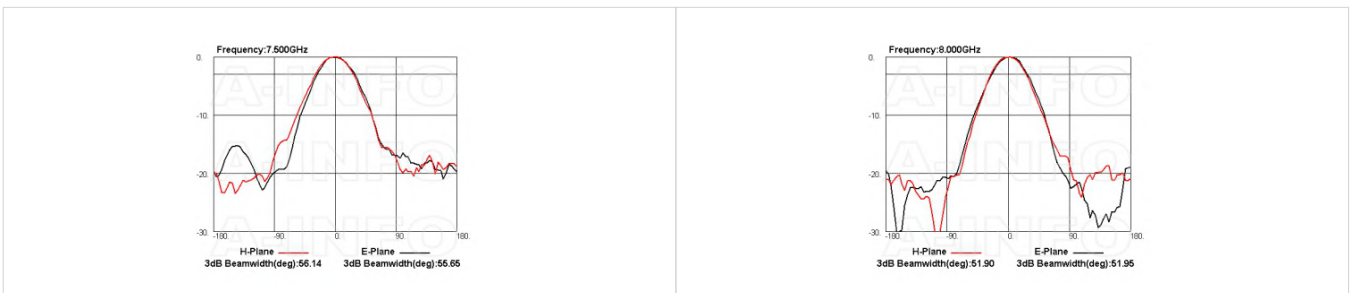

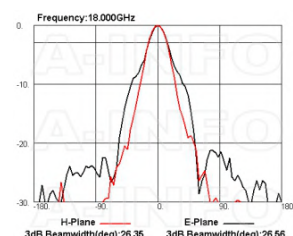
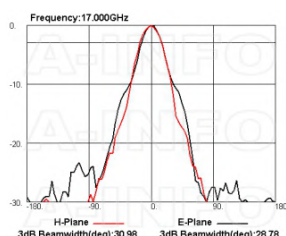
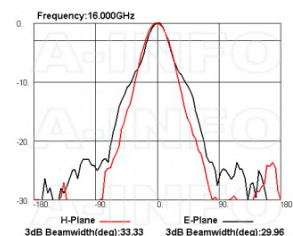
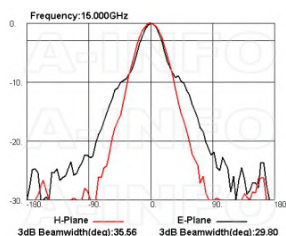
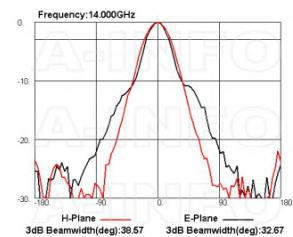
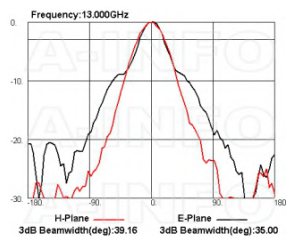
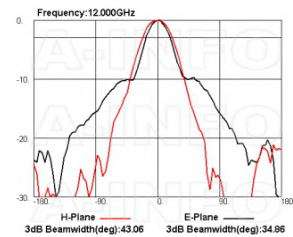
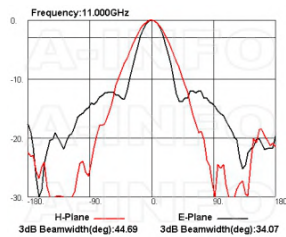
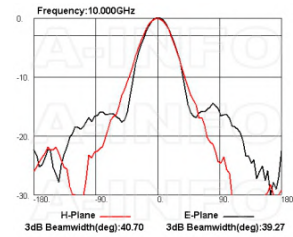
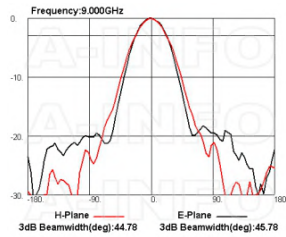

Related Products



LB-75180-10-C-MB Round Type Mounting Bracket



LB-75180-10-C-MBL L Type Mounting Bracket



Tripod_15Kg Al Alloy Tripod



3033HL Wooden Tripod



3033QM Wooden Tripod Metalfree



Carrying Case_LB-75180-10 Al Alloy Carrying Case



NM-NM-A050-500 Flexible Cable Assembly 500mm DC- 18GHz N Male to N Male



NM-NM-A050-1000 Flexible Cable Assembly 1000mm DC- 18GHz N Male to N Male



NM-NM-A050-1500 Flexible Cable Assembly 1500mm DC- 18GHz N Male to N Male



NM-NM-A050-2000 Flexible Cable Assembly 2000mm DC- 18GHz N Male to N Male



NM-NM-A050-3000 Flexible Cable Assembly 3000mm DC- 18GHz N Male to N Male



NM-NM-A050-5000 Flexible Cable Assembly 5000mm DC- 18GHz N Male to N Male



NM-NM-A050-10000 Flexible Cable Assembly 10000mm DC- 18GHz N Male to N Male



NM-NM-A050-20000 Flexible Cable Assembly 20000mm DC- 18GHz N Male to N Male



NM-NM-A100-500 Flexible Cable Assembly 500mm DC- 18GHz N Male to N Male



NM-NM-A100-1000 Flexible Cable Assembly 1000mm DC- 18GHz N Male to N Male



NM-NM-A100-1500 Flexible Cable Assembly 1500mm DC-18GHz N Male to N Male



NM-NM-A100-2000 Flexible Cable Assembly 2000mm DC-18GHz N Male to N Male



NM-NM-A100-3000 Flexible Cable Assembly 3000mm DC-18GHz N Male to N Male



NM-NM-A100-5000 Flexible Cable Assembly 5000mm DC-18GHz N Male to N Male



NM-NM-A100-10000 Flexible Cable Assembly 10000mm DC-18GHz N Male to N Male



NM-NM-A100-20000 Flexible Cable Assembly 20000mm DC-18GHz N Male to N Male

Similar Products

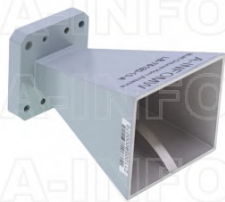

LB-75180-10-A Multi Octave Horn Antenna 7.5-18GHz 10dB Gain Double Ridge Waveguide Interface

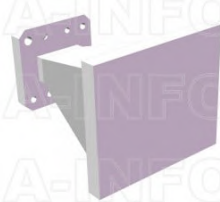

LB-75180-10-ASPO Multi Octave Horn Antenna 7.5-18GHz 10dB Gain Double Ridge Waveguide Interface



LB-75180-10-C-SF Multi Octave Horn Antenna 7.5-18GHz 10dB Gain SMA Female

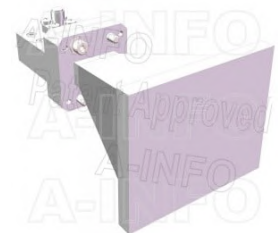

LB-75180-10-C-SFSP0 Multi Octave Horn Antenna 7.5-18GHz 10dB Gain SMA Female



LB-75180-10-C-NF Multi Octave Horn Antenna 7.5-18GHz 10dB Gain N Type Female



LB-75180-10-C-HNF Multi Octave Horn Antenna 7.5-18GHz 10dB Gain High Power N Type Female



LB-75180-10-C-HNFSP0 Multi Octave Horn Antenna 7.5-18GHz 10dB Gain High Power N Type Female

About this Datasheet

<ul style="list-style-type: none"> ● Product Information <p>Product Link: https://www.ainfoinc.com/lb-75180-10-c-nfspo-multi-octave-horn-antenna-7-5-18-ghz-10db-gain-n-type-female Data subject to change without notice. © A-INFO INC. 2024. All Rights Reserved</p>	<ul style="list-style-type: none"> ● Contact Us <p>Address: 60 Tesla, Irvine, CA 92618, USA</p> <p>Website: www.ainfoinc.com</p> <p>Email: sales@ainfoinc.com</p>	<ul style="list-style-type: none"> ● Phone & Fax <p>Phone: +1-949-639-9688 +1-949-639-9608</p> <p>Fax: +1-949-639-9670</p>
---	--	---