

LB-75180-10-C-HNFSPO Multi Octave Horn Antenna 7.5-18GHz 10dB Gain High Power N Type Female

Multi Octave Horn Antenna Operating From 7.5GHz to 18GHz With a Nominal 10dB Gain With High Power N Type Female Connector

### Product Information

SKU	LB-75180-10-C-HNFSPO
-----	----------------------

### Description

Multi octave horn antenna LB-75180-10-C-HNFSPO, operating from 7.5 to 18GHz with a nominal 10dB gain and low VSWR 1.5:1 with High Power N Type Female output connector. The model LB-75180-10-C-HNFSPO has uniform gain through its frequency span, providing efficient performance characteristics and directionality. It can handle 500W continuously and 3000W peak power. Constructed of lightweight corrosion-resistant aluminum, the horn comes with a specially designed weatherproof radome which provides excellent protection against the rain and dust but has very little loss across the full operating frequency band. This multi octave horn antenna is linearly polarized and ideally suited for EMI testing, direction finding, surveillance, antenna gain and pattern measurements and other applications.

## Technical Specification

Electrical Specification		Interface	
Frequency, Min (GHz)	7.5	Output Type	Coaxial
Frequency, Max (GHz)	18	Connector	N Type
Waveguide Type	Double Ridge	Connector Gender	Female
Waveguide Size EIA WRD	WRD750	Mechanical Specification	
Gain, Typ (dBi)	10	Figure	C Type
Polarization	Linear	Body Material	Al
3dB Beamwidth, E-Plane, Min (Deg.)	26	Finish	Gold Plated and Nickel Plated, Gray Paint
3dB Beamwidth, E-Plane, Max (Deg.)	56	Size, W (mm)	56
3dB Beamwidth, H-Plane, Min (Deg.)	26	Size, H (mm)	51.6
3dB Beamwidth, H-Plane, Max (Deg.)	57	Size, L (mm)	99.7
Cross Pol. Isolation, Typ (dB)	35	Weight, (kg)	0.3
VSWR, Typ	1.5:1		
Impedance, (Ohm)	50		
Power Handling, CW, (W)	500		
Power Handling, Peak, (W)	3000		

## Additional Information

Application	Outdoor, Waterproof and Dustproof, Fixed	Solution for	Gain Reference Antenna Measurement Far-field Measurement System Intergration
-------------	--	--------------	---

## Outline Drawing

High Power N-Female Output with Radome (Option, P/N: LB-75180-10-C-HNFSP0, Application Outdoor)

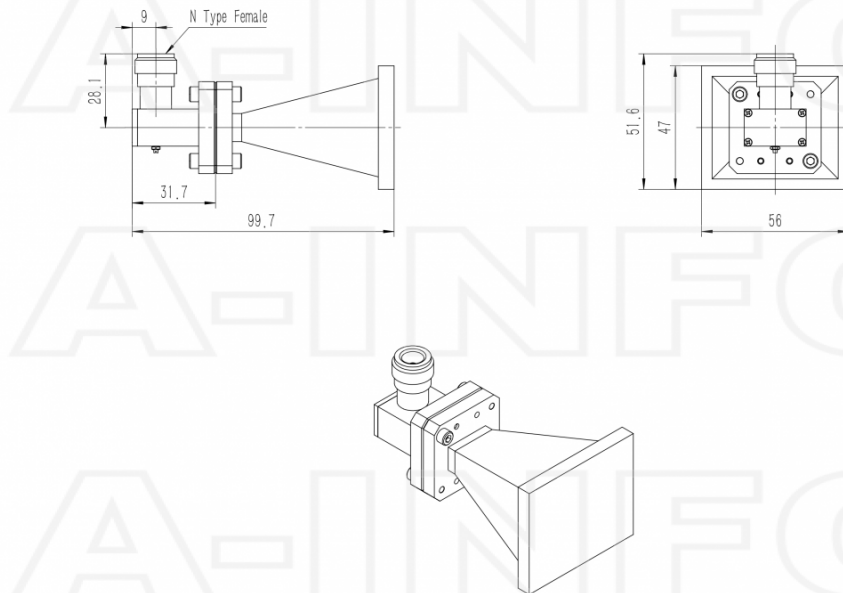

## Typical Test Results

Gain

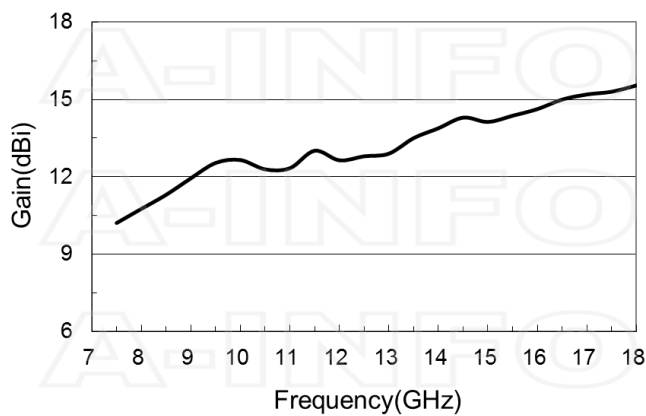

## Antenna Factor

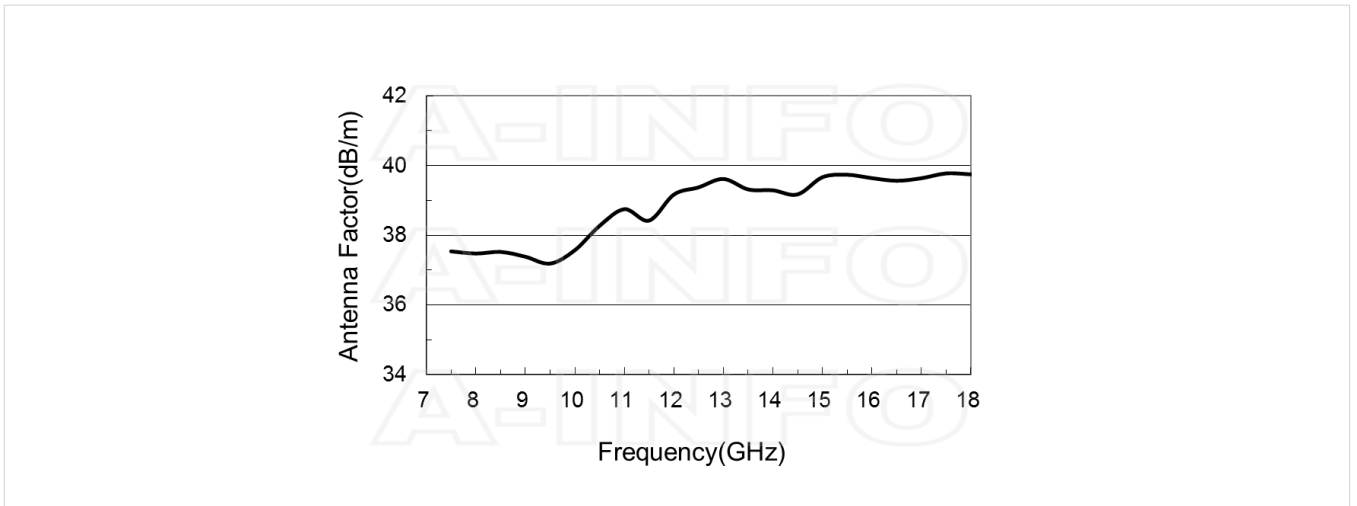

## Antenna Factor (Table)

Frequency(GHz)	Gain(dBi)	AF(dB/m)
7.5	10.21	37.50
8.0	10.76	37.51
9.0	11.95	37.35
10.0	12.65	37.56
11.0	12.34	38.70
12.0	12.64	39.15
13.0	12.90	39.59
14.0	13.89	39.25
15.0	14.13	39.60
16.0	14.63	39.66
17.0	15.20	39.62
18.0	15.55	39.77

## Cross Polarization Isolation

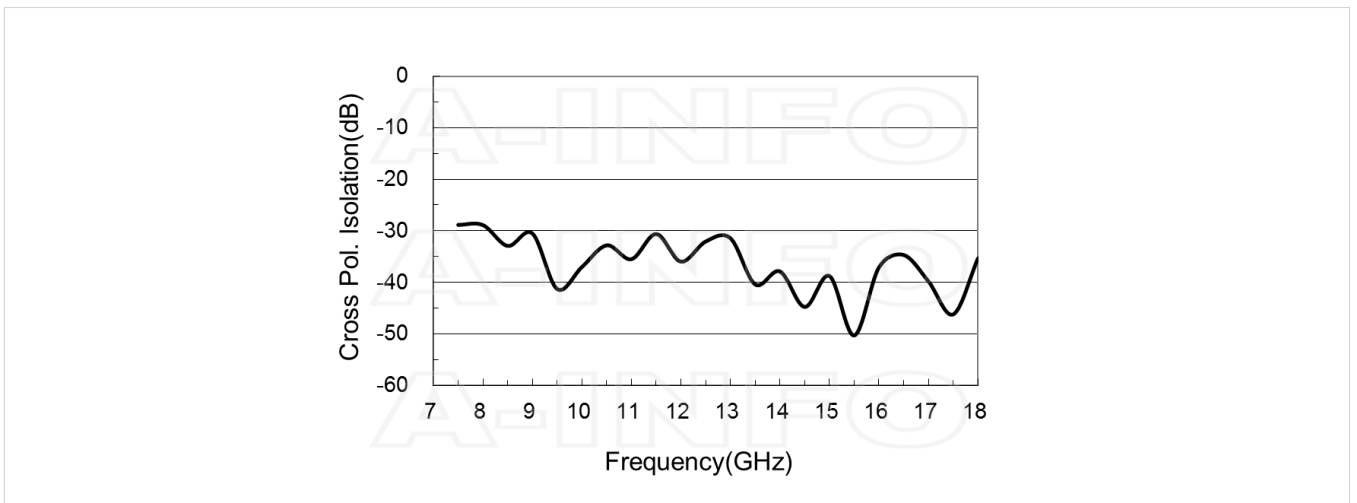

### VSWR

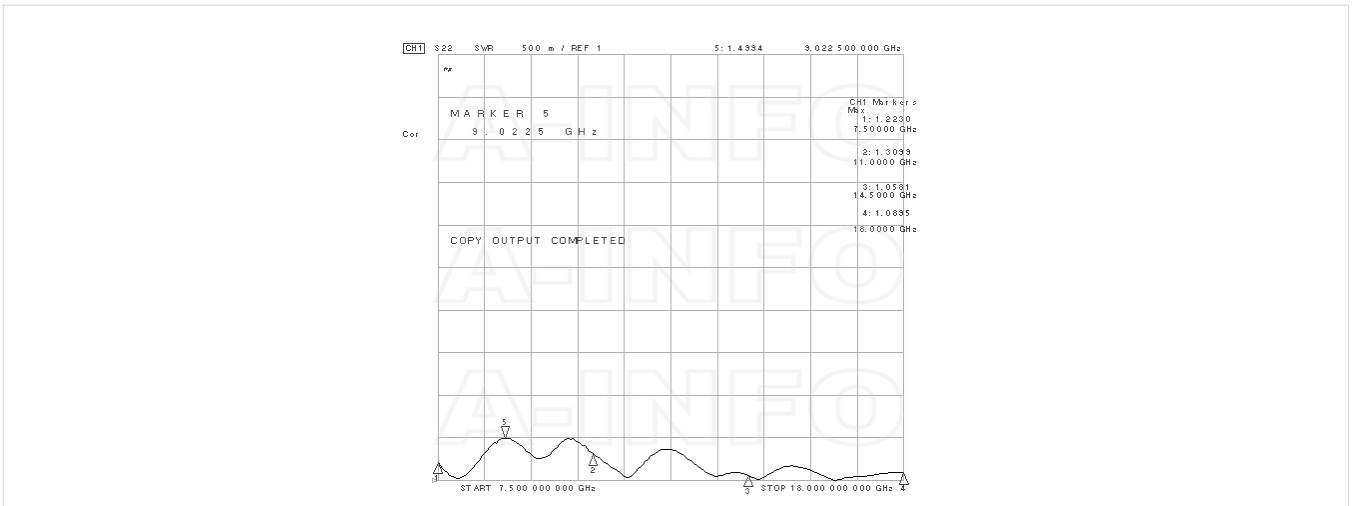

### Beamwidth

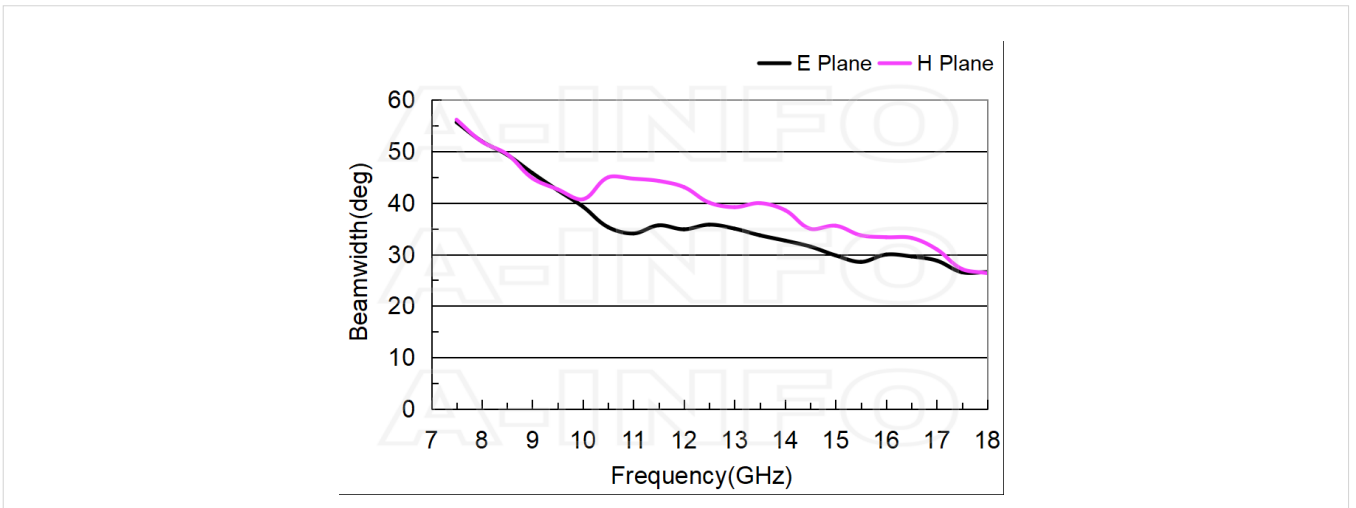

### Pattern

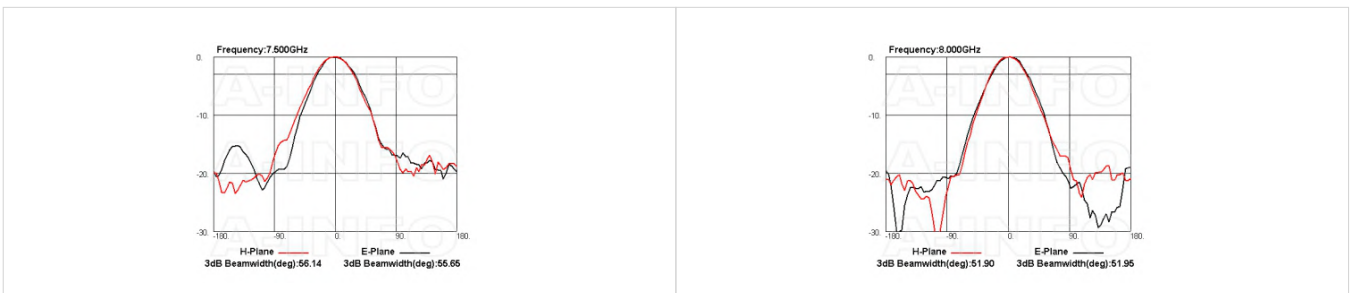

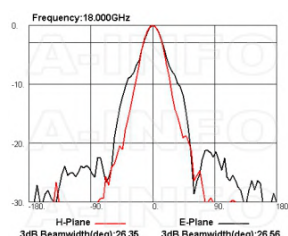
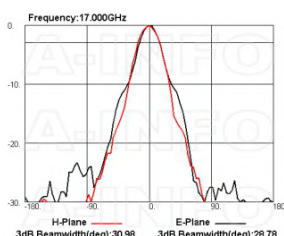
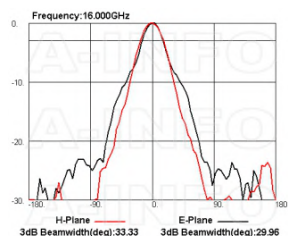
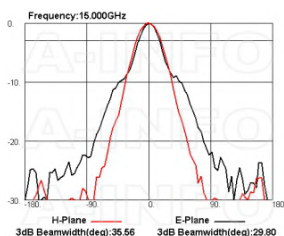
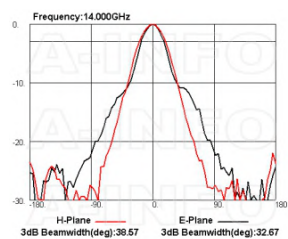
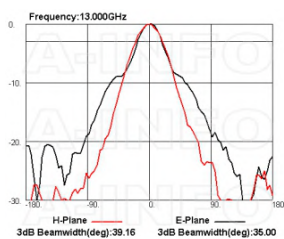
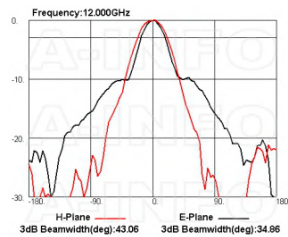
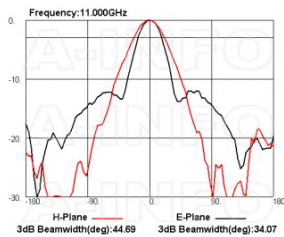
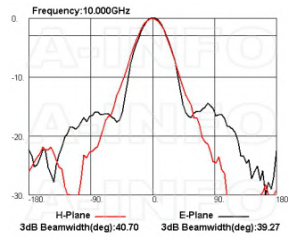
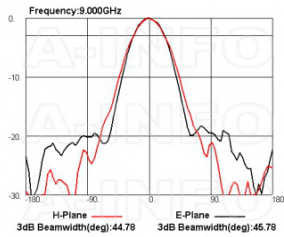

## Related Products



LB-75180-10-C-MB Round Type Mounting Bracket



LB-75180-10-C-MBL L Type Mounting Bracket



Tripod\_15Kg Al Alloy Tripod



3033HL Wooden Tripod



3033QM Wooden Tripod Metalfree



Carrying Case\_LB-75180-10 Al Alloy Carrying Case



NM-NM-A100-500 Flexible Cable Assembly 500mm DC- 18GHz N Male to N Male



NM-NM-A100-1000 Flexible Cable Assembly 1000mm DC- 18GHz N Male to N Male



NM-NM-A100-1500 Flexible Cable Assembly 1500mm DC- 18GHz N Male to N Male



NM-NM-A100-2000 Flexible Cable Assembly 2000mm DC- 18GHz N Male to N Male



NM-NM-A100-3000 Flexible Cable Assembly 3000mm DC- 18GHz N Male to N Male



NM-NM-A100-5000 Flexible Cable Assembly 5000mm DC- 18GHz N Male to N Male



NM-NM-A100-10000 Flexible Cable Assembly 10000mm DC- 18GHz N Male to N Male



NM-NM-A100-20000 Flexible Cable Assembly 20000mm DC- 18GHz N Male to N Male

### Similar Products



LB-75180-10-A Multi Octave Horn Antenna 7.5-18GHz 10dB Gain Double Ridge Waveguide Interface



LB-75180-10-ASPO Multi Octave Horn Antenna 7.5-18GHz 10dB Gain Double Ridge Waveguide Interface



LB-75180-10-C-SF Multi Octave Horn Antenna 7.5-18GHz 10dB Gain SMA Female

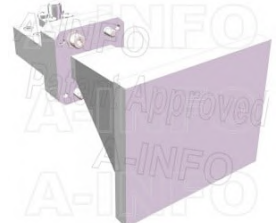

LB-75180-10-C-SFSPO Multi Octave Horn Antenna 7.5-18GHz 10dB Gain SMA Female



LB-75180-10-C-NF Multi Octave Horn Antenna 7.5-18GHz 10dB Gain N Type Female

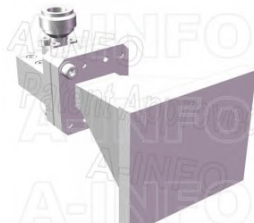

LB-75180-10-C-NFSPO Multi Octave Horn Antenna 7.5-18GHz 10dB Gain N Type Female



LB-75180-10-C-HNF Multi Octave Horn Antenna 7.5-18GHz 10dB Gain High Power N Type Female

### About this Datasheet

- Product Information

Product Link:

<https://www.ainfoinc.com/lb-75180-10-c-hnfspo-multi-octave-horn-antenna-7-5-18-ghz-10db-gain-high-power-n-type-female>

Data subject to change without notice.  
© A-INFO INC. 2024. All Rights Reserved

- Contact Us

Address:

60 Tesla, Irvine, CA 92618, USA

Website:

[www.ainfoinc.com](http://www.ainfoinc.com)

Email:

[sales@ainfoinc.com](mailto:sales@ainfoinc.com)

- Phone & Fax

Phone:

+1-949-639-9688

+1-949-639-9608

Fax:

+1-949-639-9670