

LB-65180-25-ASPO Multi Octave Horn Antenna 6.5-18GHz 25dB Gain
Double Ridge Waveguide Interface

Multi Octave Horn Antenna From 6.5GHz to 18GHz With a Nominal 25dB
Gain With Double Ridge Waveguide Interface

Product Information

SKU	LB-65180-25-ASPO
-----	------------------

Description

Multi octave horn antenna LB-65180-25-ASPO, operating from 6.5 to 18GHz with a nominal 25dB gain and low VSWR 1.5:1 with FPWRD650D28 output. The model LB-65180-25-ASPO has uniform gain through its frequency span, providing efficient performance characteristics and directionality. Constructed of lightweight corrosion-resistant aluminum, the horn comes with a specially designed weatherproof radome which provides excellent protection against the rain and dust but has very little loss across the full operating frequency band. This multi octave horn antenna is linearly polarized and ideally suited for EMI testing, direction finding, surveillance, antenna gain and pattern measurements and other applications.

Technical Specification

Electrical Specification		Interface	
Frequency, Min (GHz)	6.5	Output Type	Waveguide
Frequency, Max (GHz)	18	Flange Designation, WRD	FPWRD650D28
Waveguide Type	Double Ridge	Connector Gender	N/A
Waveguide Size EIA WRD	WRD650	Mechanical Specification	
Gain, Typ (dBi)	25	Figure	A Type
Polarization	Linear	Body Material	Al
3dB Beamwidth, E-Plane, Min (Deg.)	5	Finish	Chemical Conversion Coating, Gray Paint
3dB Beamwidth, E-Plane, Max (Deg.)	13	Size, W (mm)	241
3dB Beamwidth, H-Plane, Min (Deg.)	6	Size, H (mm)	200
3dB Beamwidth, H-Plane, Max (Deg.)	14	Size, L (mm)	716
Cross Pol. Isolation, Typ (dB)	30		
VSWR, Typ	1.5:1		

Additional Information

Application	Outdoor, Waterproof and Dustproof, Fixed	Solution for	Gain Reference Antenna Measurement Far-field Measurement System Intergration
-------------	------------------------------------------	--------------	------------------------------------------------------------------------------------

Outline Drawing

FPWRD650D28 Output with Radome (Option, P/N: LB-65180-25-ASPO, Application Outdoor)

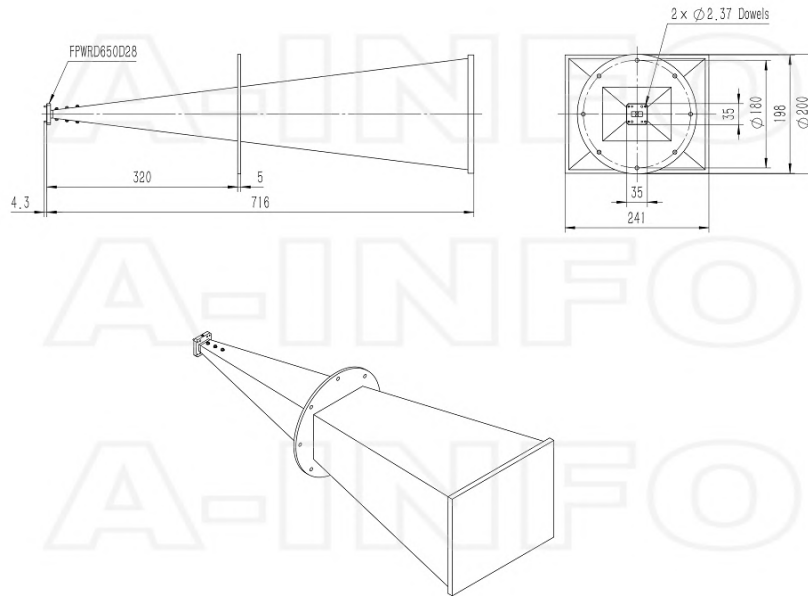

Flange Drawing

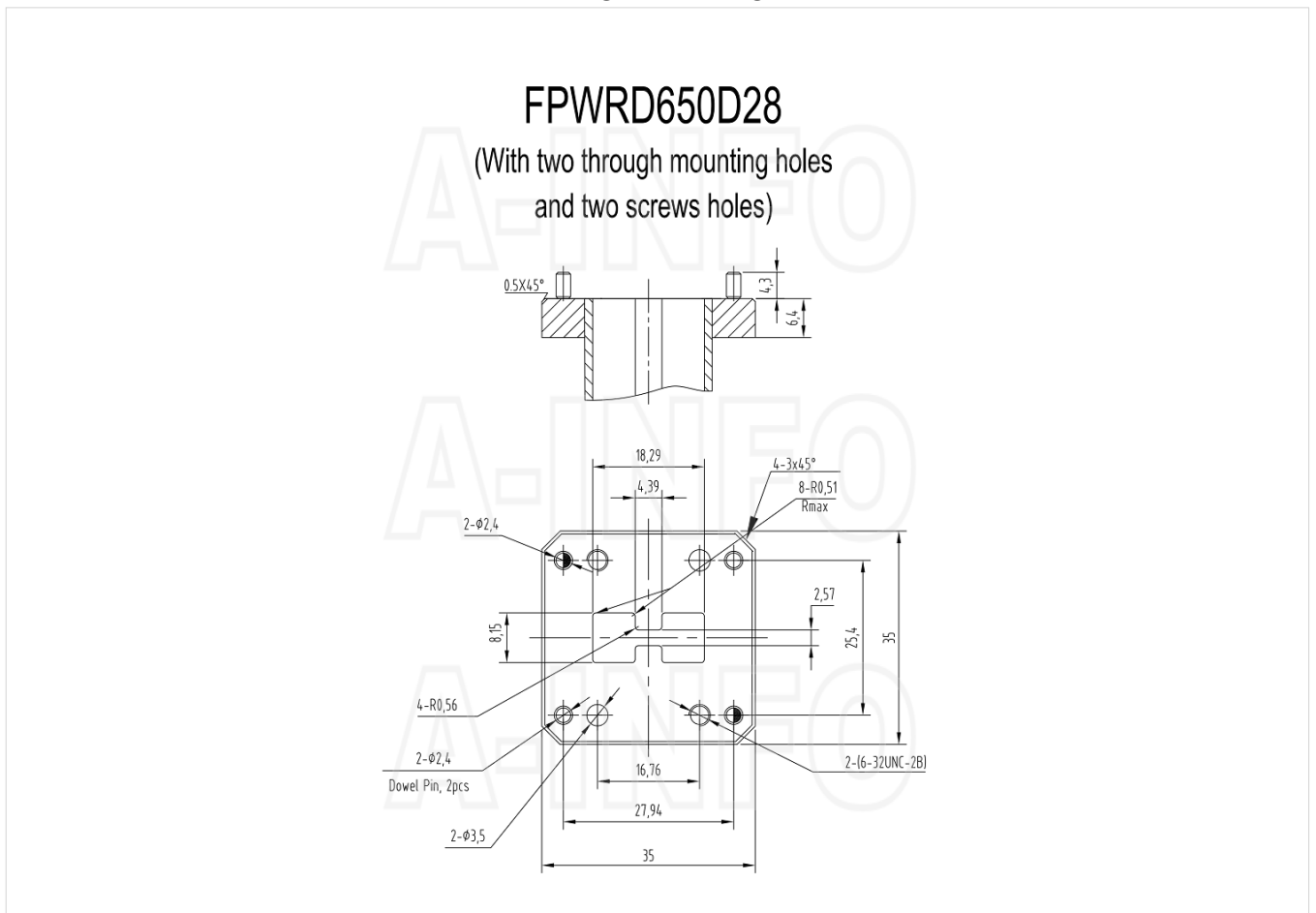

Typical Test Results

Gain

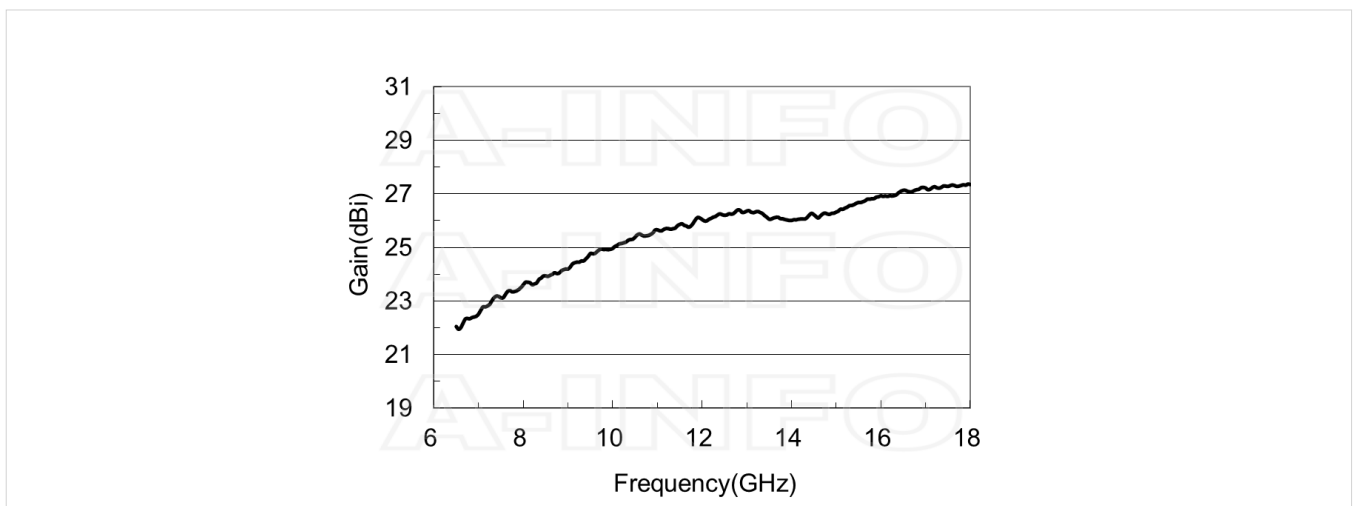

Antenna Factor

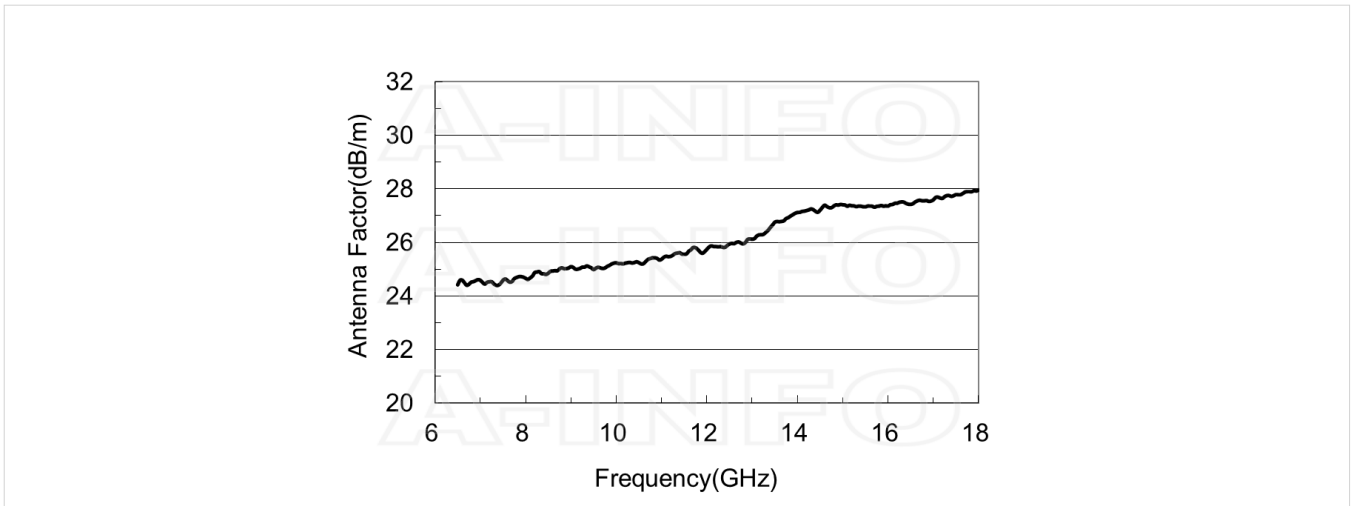

Antenna Factor (Table)

Frequency(GHz)	Gain(dBi)	AF(dB/m)
6.5	22.05	24.42
7.0	22.52	24.59
8.0	23.61	24.66
9.0	24.20	25.10
10.0	24.97	25.24
11.0	25.66	25.38
12.0	26.05	25.75
13.0	26.36	26.13
14.0	26.01	27.12
15.0	26.32	27.41
16.0	26.93	27.36
17.0	27.22	27.59
18.0	27.35	27.96

Cross Polarization Isolation

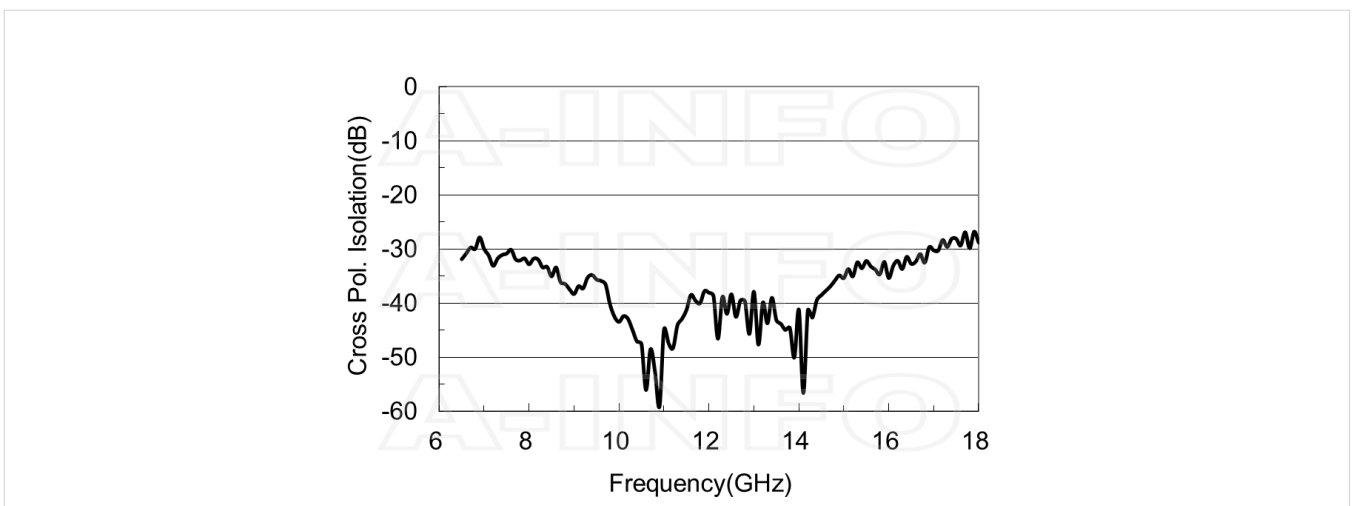

VSWR

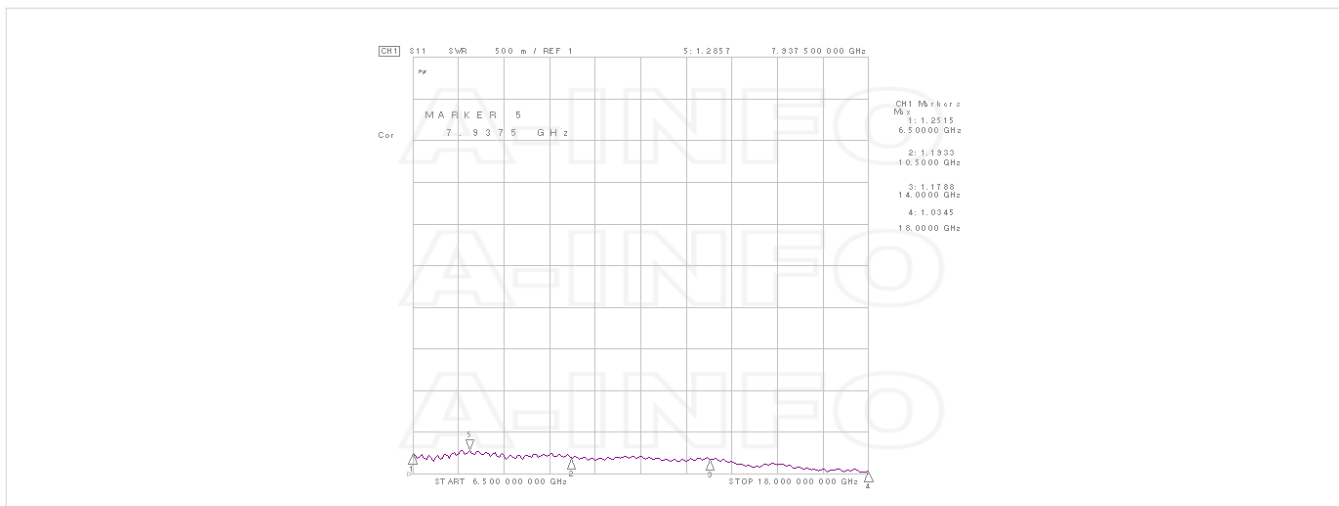

Beamwidth

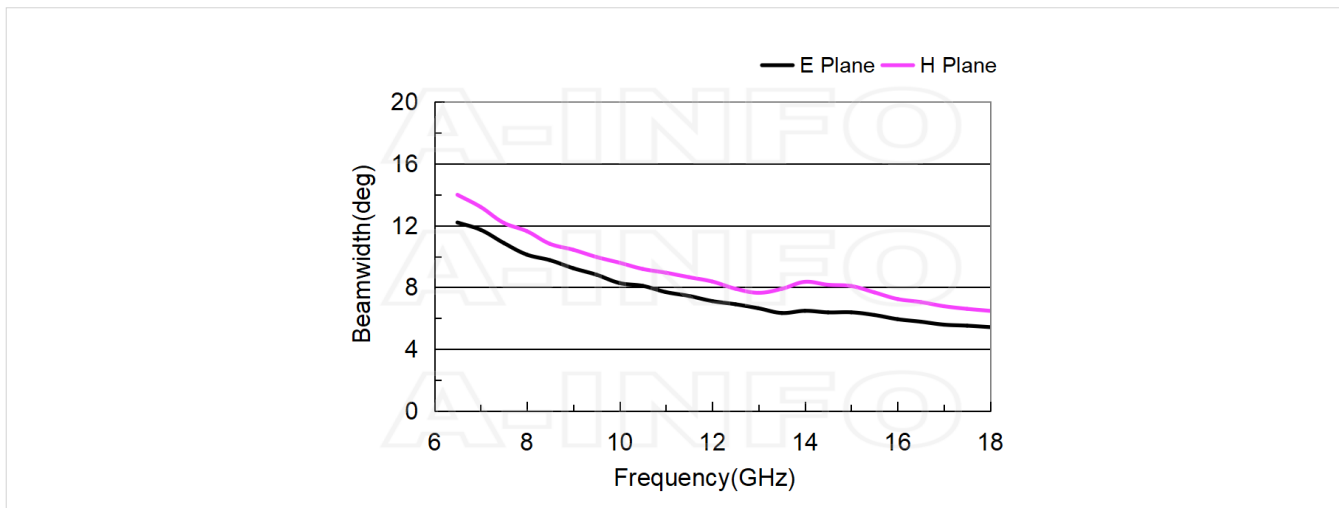

Pattern

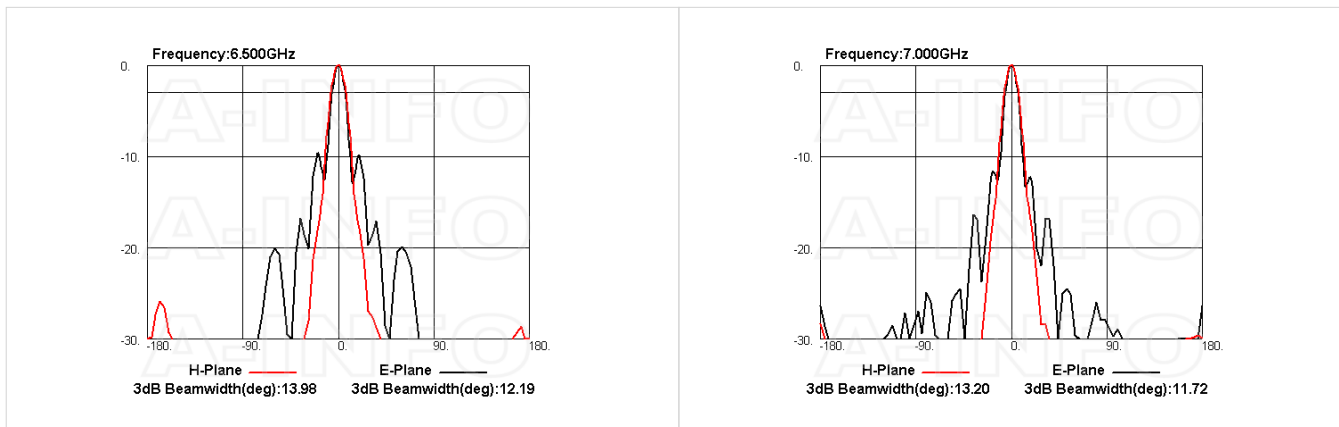

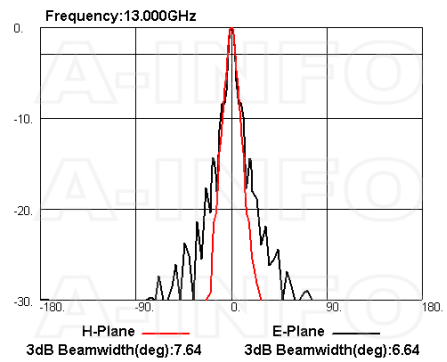
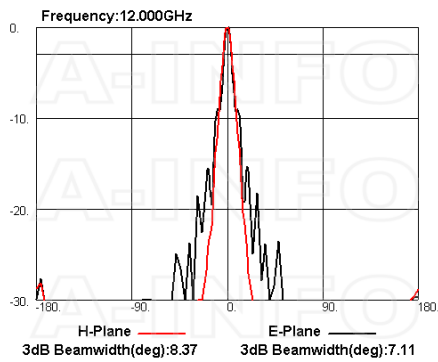
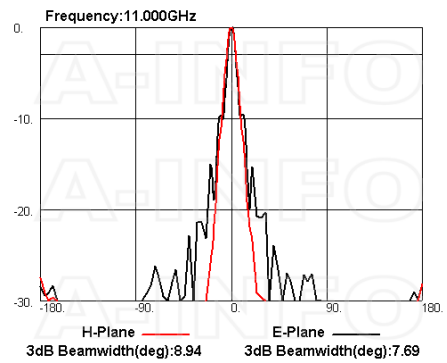
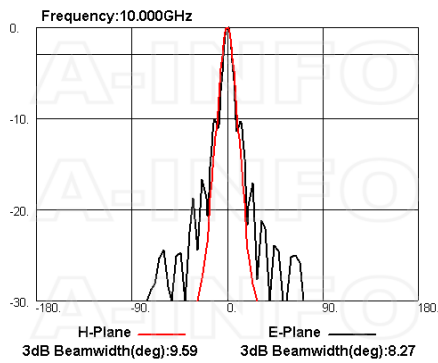
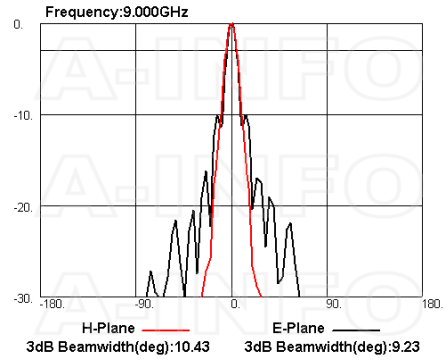
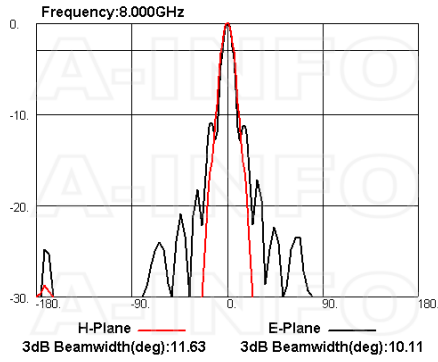

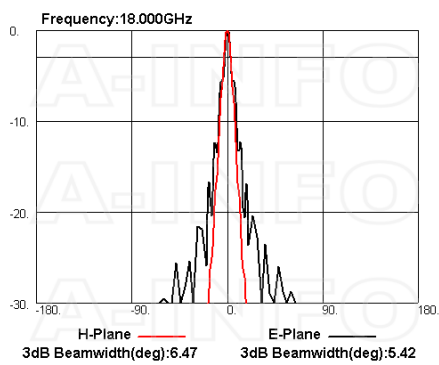
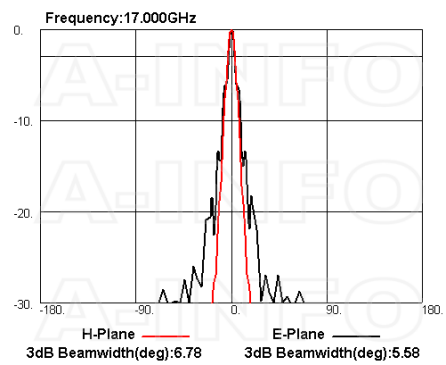
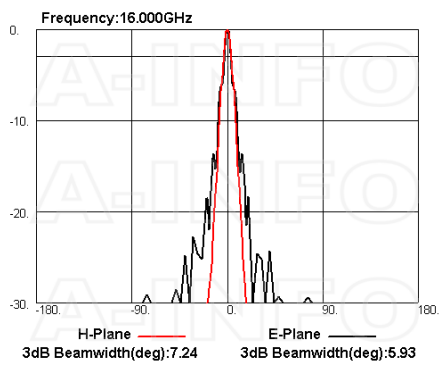
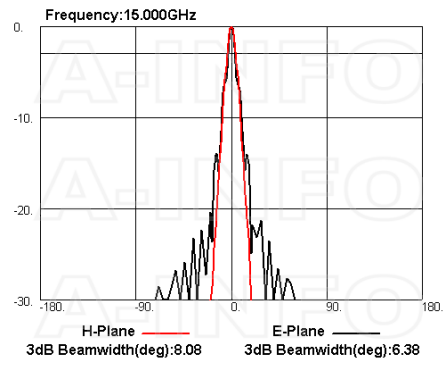
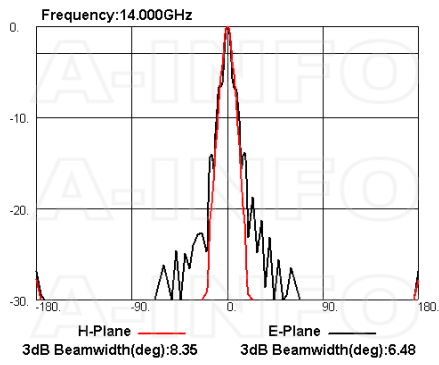

Related Products



650DRWCAN_Cu Right Angle Double Ridge Waveguide to Coaxial Adapter 6.5-18GHz WRD650 to N Type Female



650DRWCAS_Cu Right Angle Double Ridge Waveguide to Coaxial Adapter 6.5-18GHz WRD650 to SMA Female



650DRWECAN_Cu Endlaunch Double Ridge Waveguide to Coaxial Adapter 6.5-18GHz WRD650 to N Type Female



650DRWECANM_Cu Endlaunch Double Ridge Waveguide to Coaxial Adapter 6.5-18GHz WRD650 to N Type Male



650DRWECAS_Cu Endlaunch Double Ridge Waveguide to Coaxial Adapter 6.5-18GHz WRD650 to SMA Female



650DRWHCAN_Cu Right Angle High Power Double Ridge Waveguide to Coaxial Adapter 6.5-18GHz WRD650 to N Type Female



LB-90-25-MB2 Round Type Mounting Bracket



LB-90-25-L2 L Type Mounting Bracket



Tripod_15Kg Al Alloy Tripod



3033HL Wooden Tripod



3033QM Wooden Tripod Metalfree

Similar Products



LB-65180-25-A Multi Octave Horn Antenna 6.5-18GHz 25dB Gain Double Ridge Waveguide Interface



LB-65180-25-C-NF Multi Octave Horn Antenna 6.5-18GHz 25dB Gain N Type Female

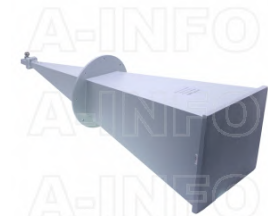

LB-65180-25-C-NFSPO Multi Octave Horn Antenna 6.5-18GHz 25dB Gain N Type Female



LB-65180-25-C-SF Multi Octave Horn Antenna 6.5-18GHz 25dB Gain SMA Female



LB-65180-25-C-SFSPO Multi Octave Horn Antenna 6.5-18GHz 25dB Gain SMA Female



LB-65180-25-C-HNF Multi Octave Horn Antenna 6.5-18GHz 25dB Gain High Power N Type Female

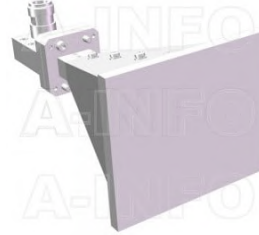

LB-65180-25-C-HNFSPO Multi Octave Horn Antenna 6.5-18GHz 25dB Gain High Power N Type Female

About this Datasheet

<ul style="list-style-type: none"> ● Product Information Product Link: https://www.ainfoinc.com/lb-65180-25-aspo-multi-octave-horn-antenna-6-5-18-ghz-25db-gain-fpwr650d28 Data subject to change without notice. © A-INFO INC. 2024. All Rights Reserved 	<ul style="list-style-type: none"> ● Contact Us Address: 60 Tesla, Irvine, CA 92618, USA Website: www.ainfoinc.com Email: sales@ainfoinc.com 	<ul style="list-style-type: none"> ● Phone & Fax Phone: +1-949-639-9688 +1-949-639-9608 Fax: +1-949-639-9670
-------------------------------------------------------------------------------------------------------------------------------------------------------------------------------------------------------------------------------------------------------------------------------------------------------------------------------------------------------------------------------------------------------------------	--------------------------------------------------------------------------------------------------------------------------------------------------------------------------------------------------------------------------------------------------------------------------	------------------------------------------------------------------------------------------------------------------------------------------------------------