

LB-65180-20-C-SFSPO Multi Octave Horn Antenna 6.5-18GHz 20dB Gain SMA Female



Multi Octave Horn Antenna Operating From 6.5GHz to 18GHz With a Nominal 20dB Gain With SMA Female Connector

Product Information

SKU	LB-65180-20-C-SFSPO
-----	---------------------

Description

Multi octave horn antenna LB-65180-20-C-SFSPO, operating from 6.5 to 18GHz with a nominal 20dB gain and low VSWR 1.5:1 with SMA Female output connector. The model LB-65180-20-C-SFSPO has uniform gain through its frequency span, providing efficient performance characteristics and directionality. It can handle 50W continuously and 1000W peak power. Constructed of lightweight corrosion-resistant aluminum, the horn comes with a specially designed weatherproof radome which provides excellent protection against the rain and dust but has very little loss across the full operating frequency band. This multi octave horn antenna is linearly polarized and ideally suited for EMI testing, direction finding, surveillance, antenna gain and pattern measurements and other applications.

Technical Specification

Electrical Specification		Interface	
Frequency, Min (GHz)	6.5	Output Type	Coaxial
Frequency, Max (GHz)	18	Connector	SMA
Waveguide Type	Double Ridge	Connector Gender	Female
Waveguide Size EIA WRD	WRD650	Mechanical Specification	
Gain, Typ (dBi)	20	Figure	C Type
Polarization	Linear	Body Material	Al
3dB Beamwidth, E-Plane, Min (Deg.)	7	Finish	Passivation and Chemical Conversion Coating, Gray Paint
3dB Beamwidth, E-Plane, Max (Deg.)	26	Size, W (mm)	132
3dB Beamwidth, H-Plane, Min (Deg.)	8	Size, H (mm)	112
3dB Beamwidth, H-Plane, Max (Deg.)	29	Size, L (mm)	265
Cross Pol. Isolation, Typ (dB)	40	Weight, (kg)	0.57
VSWR, Typ	1.5:1		
Impedance, (Ohm)	50		
Power Handling, CW, (W)	50		
Power Handling, Peak, (W)	1000		

Additional Information

Application	Outdoor, Waterproof and Dustproof, Fixed	Solution for	Gain Reference Antenna Measurement Far-field Measurement System Intergration
-------------	--	--------------	---

Outline Drawing

SMA-Female Output with Radome (Option, P/N: LB-65180-20-C-SFSPO, Application Outdoor)

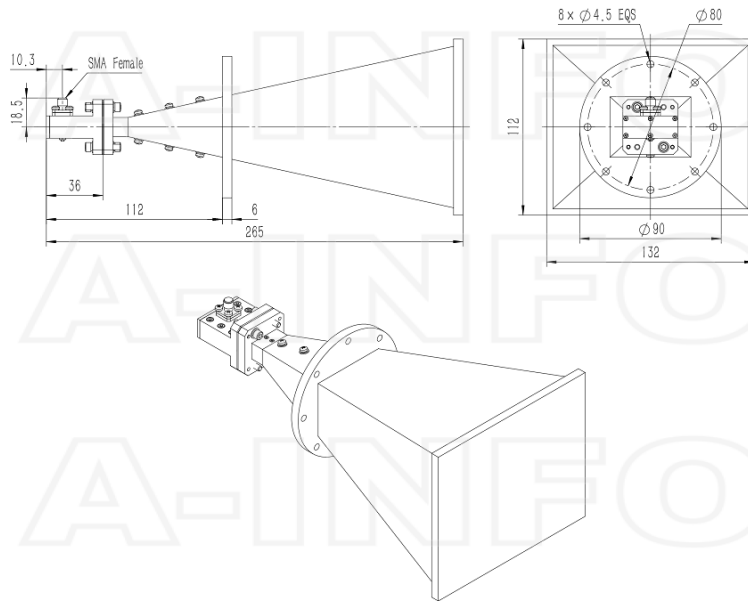

SMA-Female Output with L Type Mounting Bracket & Radome (Option, P/N: LB-65180-20-C-L & LB-65180-20-C-SFSPO, Application Outdoor)

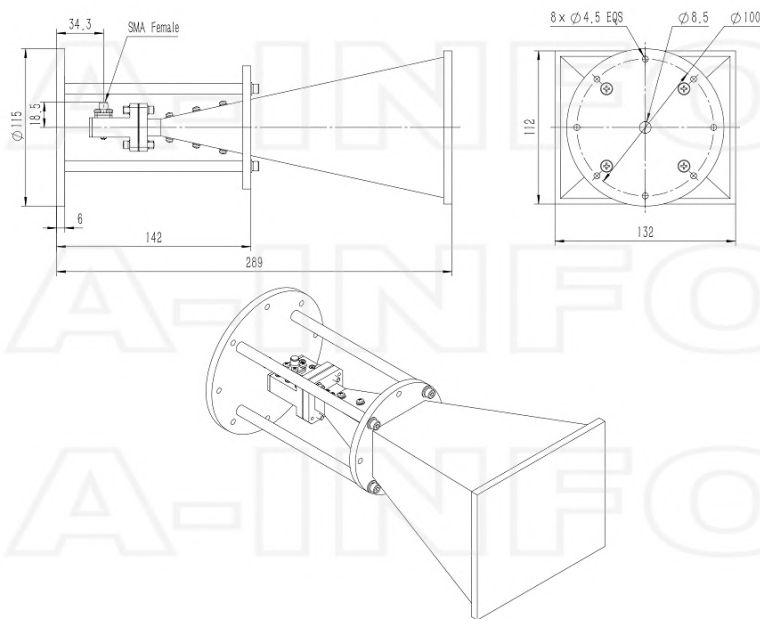

SMA-Female Output with Round Mounting Bracket & Radome (Option, P/N: LB-65180-20-C-MB & LB-65180-20-C-SFSP0, Application Outdoor)

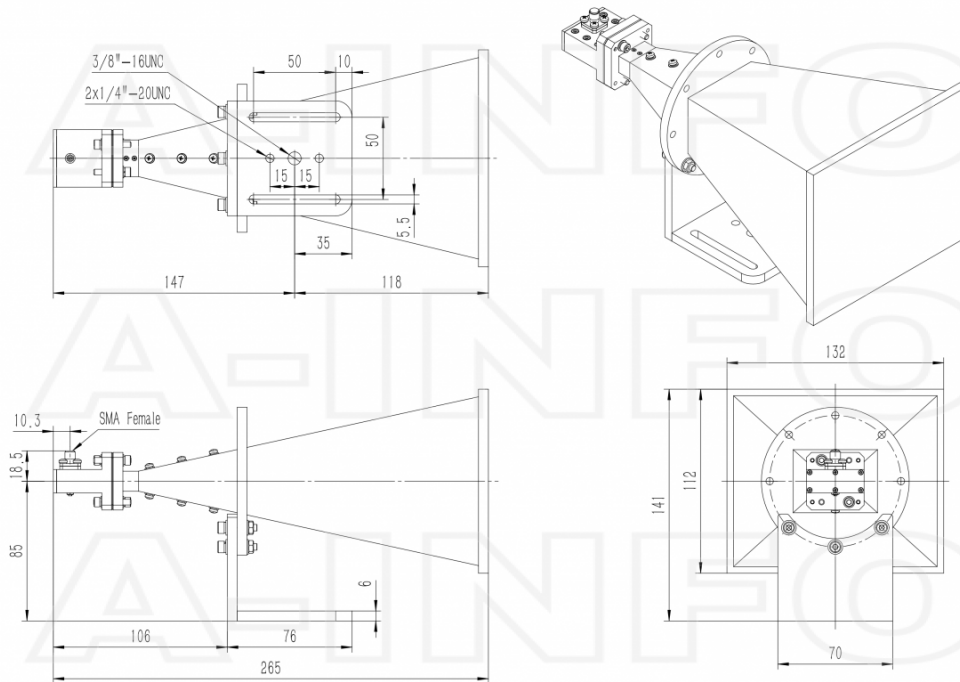

Typical Test Results

Gain

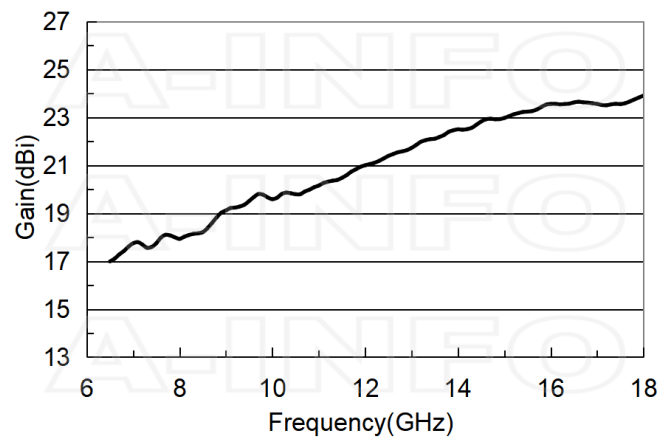

Antenna Factor

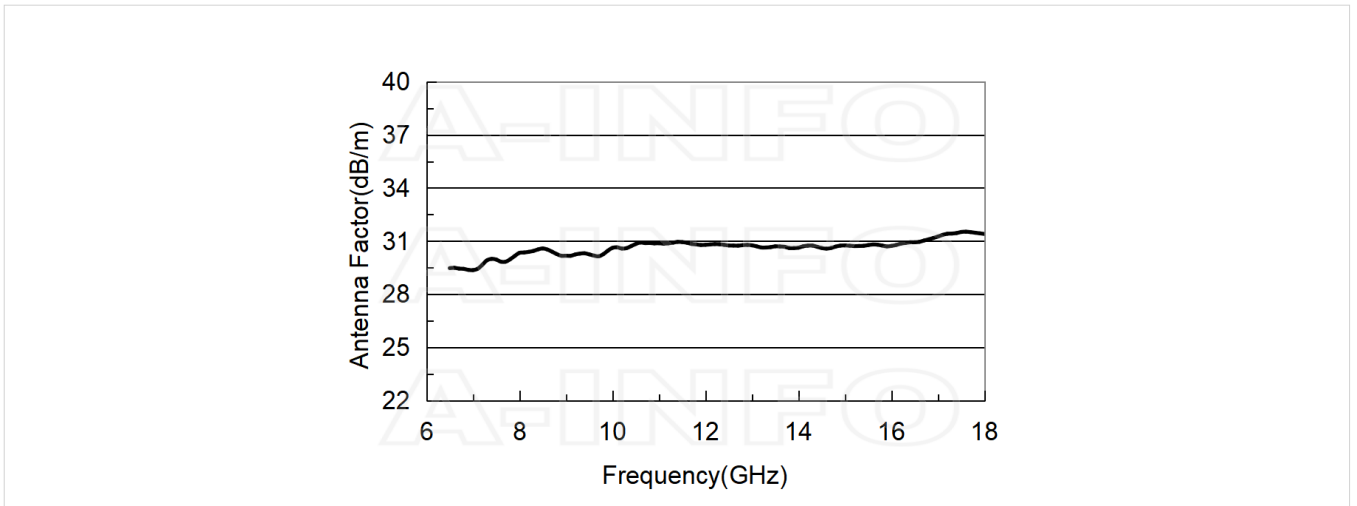

Antenna Factor (Table)

Frequency(GHz)	Gain(dBi)	AF(dB/m)
6.5	16.99	29.48
7.0	17.75	29.37
8.0	17.93	30.34
9.0	19.12	30.18
10.0	19.59	30.62
11.0	20.16	30.88
12.0	21.00	30.79
13.0	21.73	30.76
14.0	22.50	30.63
15.0	22.97	30.76
16.0	23.56	30.73
17.0	23.56	31.26
18.0	23.91	31.41

Cross Polarization Isolation

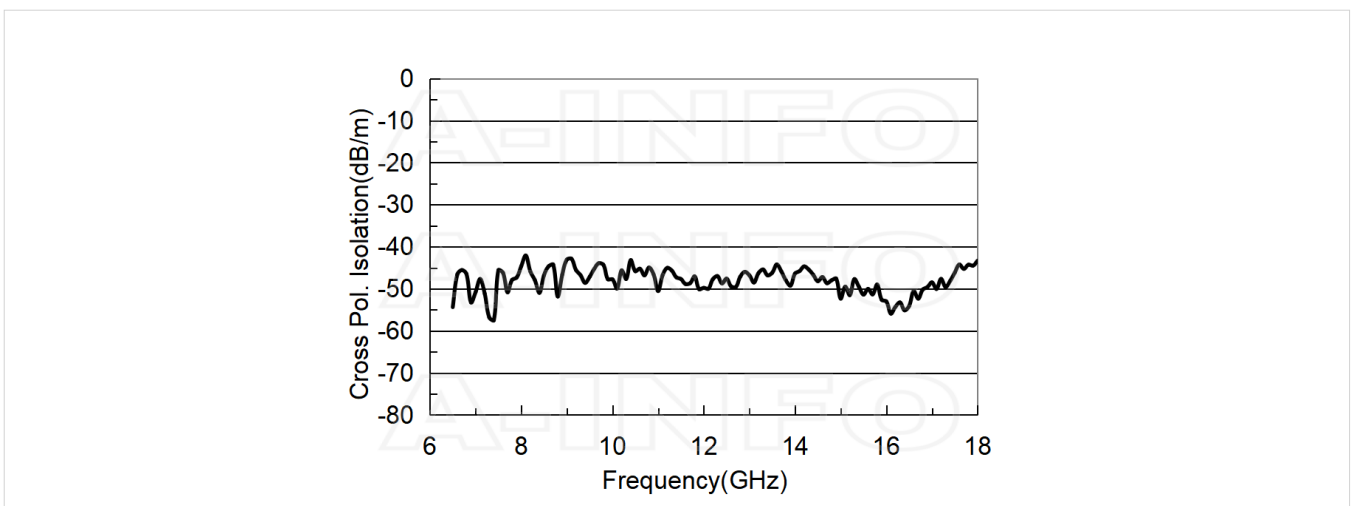

VSWR

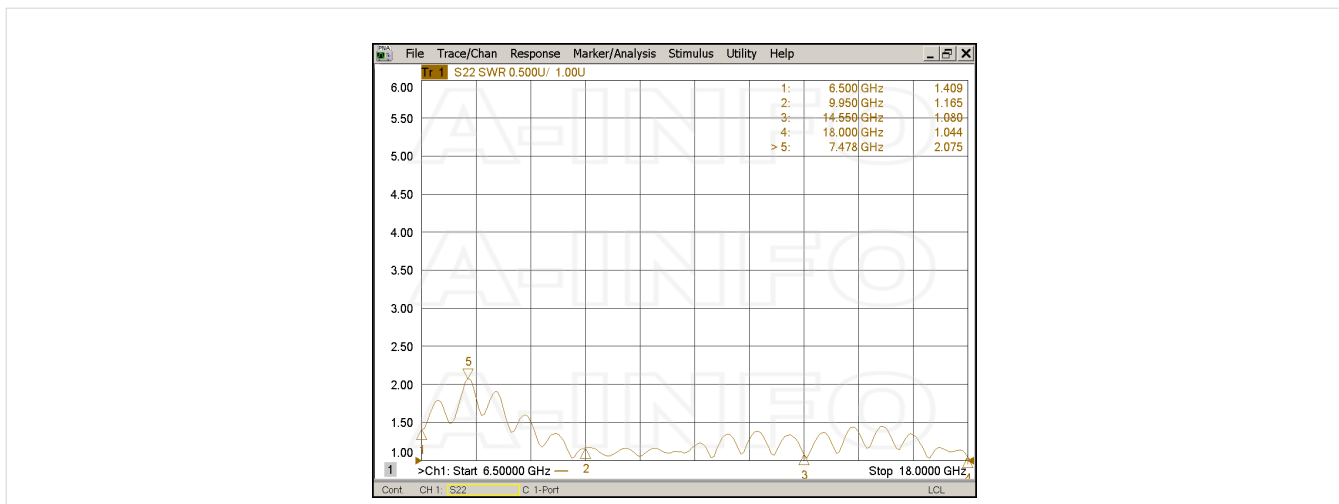

Beamwidth

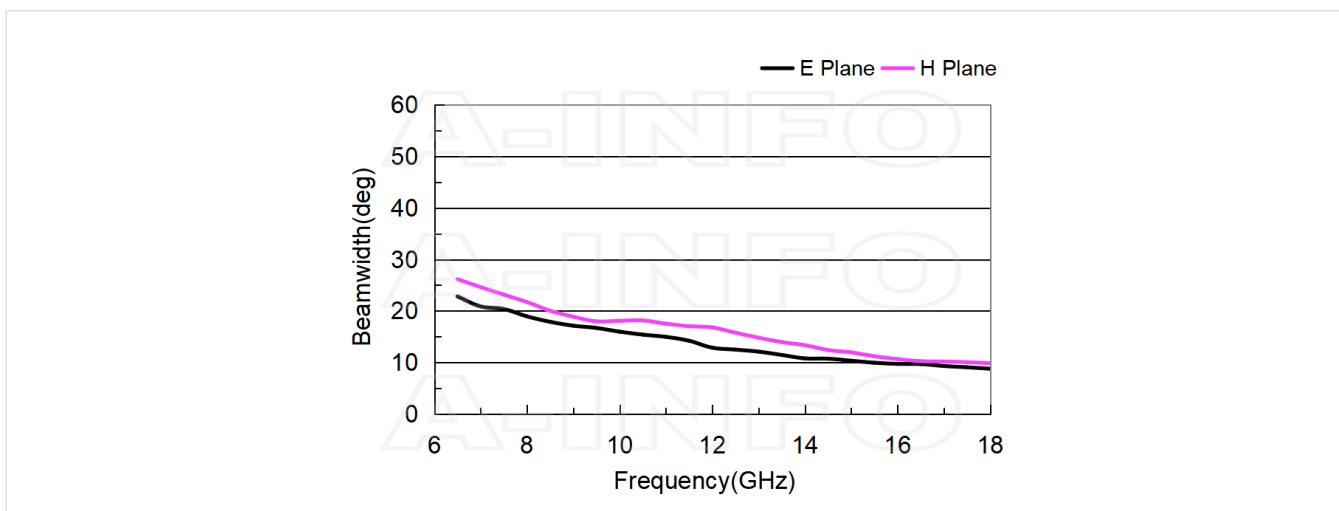

Pattern

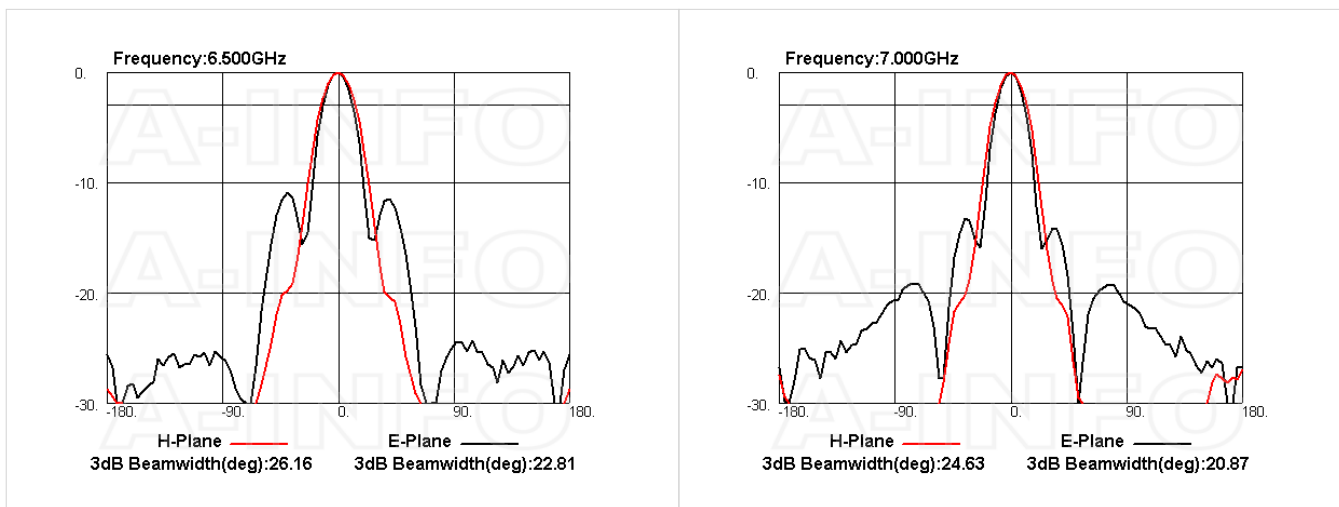

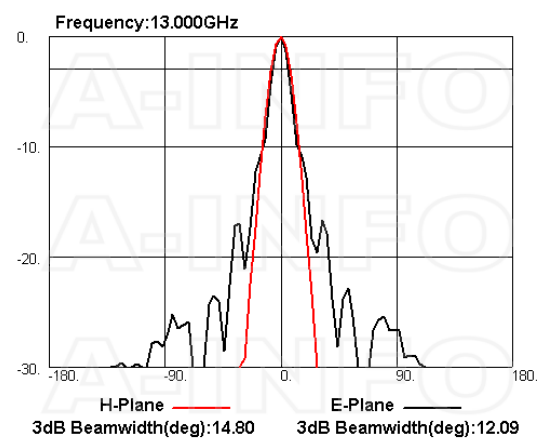
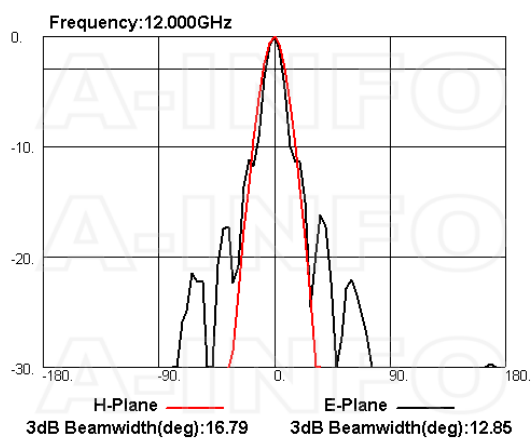
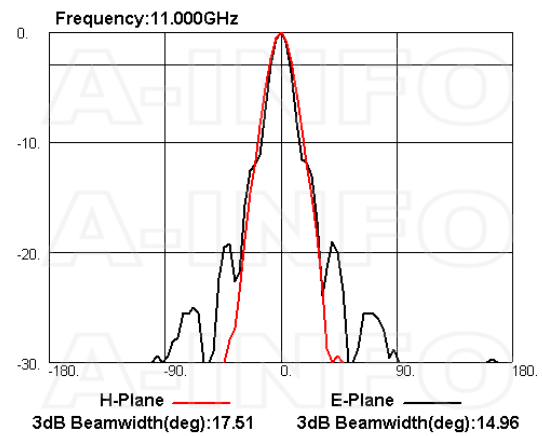
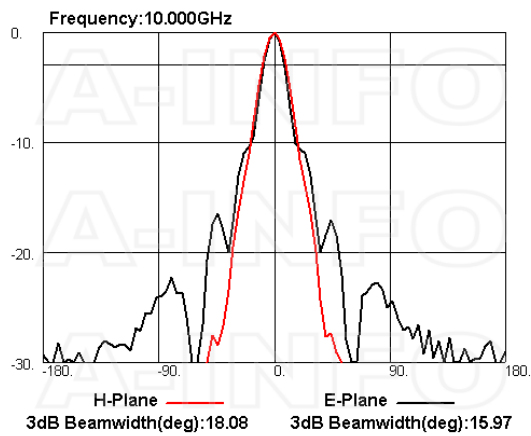
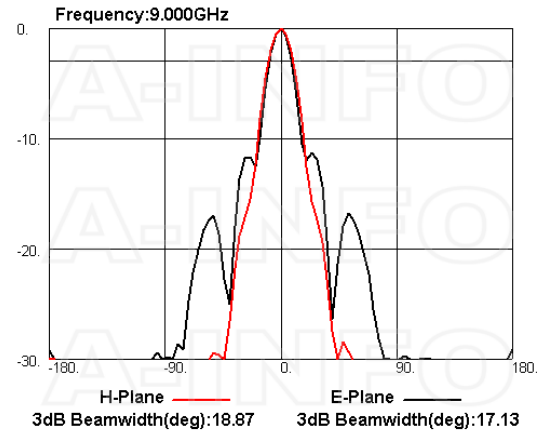
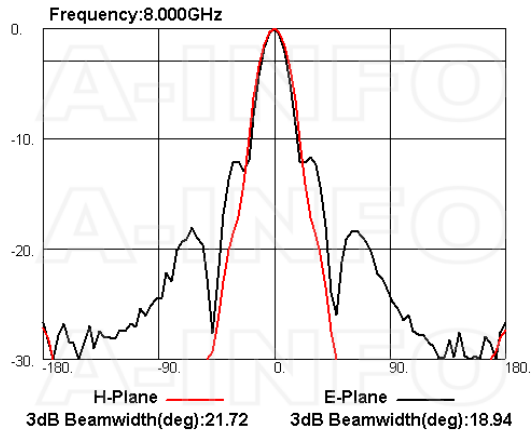

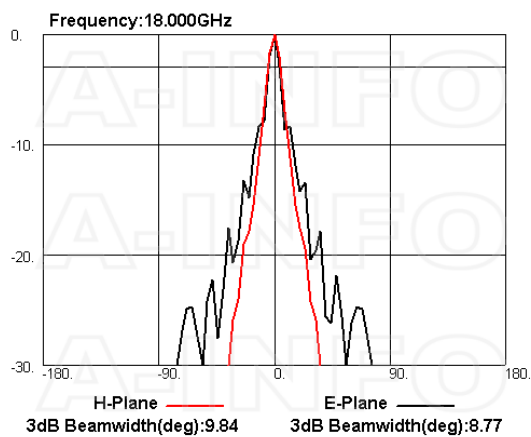
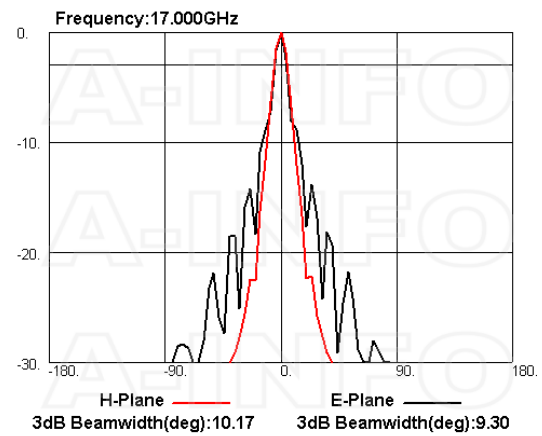
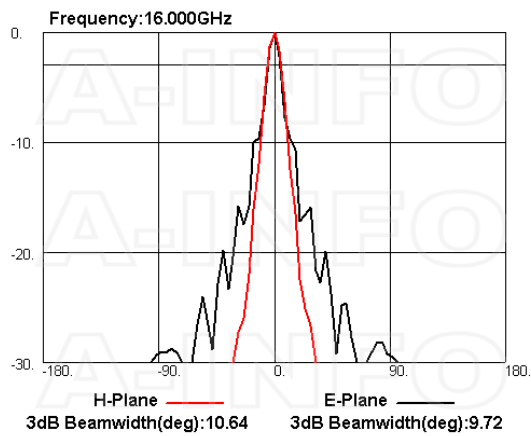
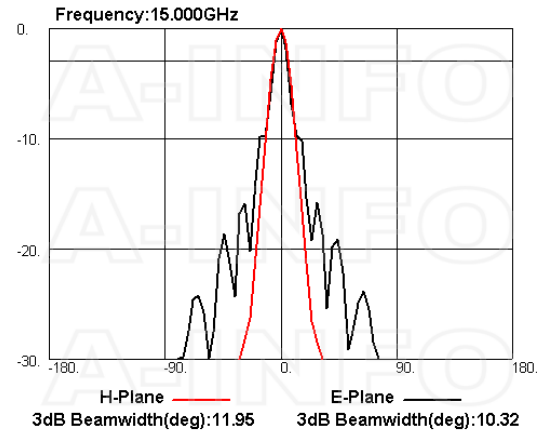
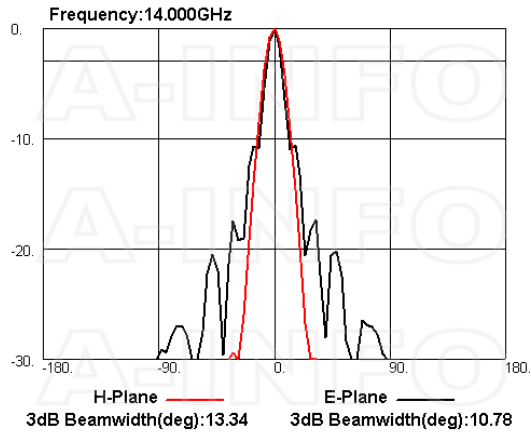

Related Products



LB-65180-20-C-MB Round Type Mounting Bracket



LB-65180-20-C-L L type mounting bracket



LB-65180-20-C-MA Stinger Type Mounting Bracket



Tripod_15Kg Al Alloy Tripod



3033HL Wooden Tripod



3033QM Wooden Tripod Metalfree



Carrying Case_LB-65180-20-C Al Alloy Carrying Case



SM-SM-A050-1000 Flexible Cable Assembly 1000mm DC- 26.5GHz SMA Male to SMA Male



SM-SM-A050-1500 Flexible Cable Assembly 1500mm DC- 26.5GHz SMA Male to SMA Male



SM-SM-A050-2000 Flexible Cable Assembly 2000mm DC- 26.5GHz SMA Male to SMA Male



SM-SM-A050-3000 Flexible Cable Assembly 3000mm DC- 26.5GHz SMA Male to SMA Male



SM-SM-A050-5000 Flexible Cable Assembly 5000mm DC- 26.5GHz SMA Male to SMA Male



SM-SM-A050-10000 Flexible Cable Assembly 10000mm DC- 26.5GHz SMA Male to SMA Male



SM-SM-A080-500 Flexible Cable Assembly 500mm DC- 26.5GHz SMA Male to SMA Male



SM-SM-A080-1000 Flexible Cable Assembly 1000mm DC- 26.5GHz SMA Male to SMA Male



SM-SM-A080-1500 Flexible Cable Assembly 1500mm DC- 26.5GHz SMA Male to SMA Male



SM-SM-A080-2000 Flexible Cable Assembly 2000mm DC- 26.5GHz SMA Male to SMA Male



SM-SM-A080-3000 Flexible Cable Assembly 3000mm DC- 26.5GHz SMA Male to SMA Male



SM-SM-A080-5000 Flexible Cable Assembly 5000mm DC- 26.5GHz SMA Male to SMA Male



SM-SM-A080-10000 Flexible Cable Assembly 10000mm DC- 26.5GHz SMA Male to SMA Male



SM-SM-A080-20000 Flexible Cable Assembly 20000mm DC- 26.5GHz SMA Male to SMA Male



SM-SM-A100-100 Flexible Cable Assembly 100mm DC- 18GHz SMA Male to SMA Male



SM-SM-A100-200 Flexible Cable Assembly 200mm DC- 18GHz SMA Male to SMA Male



SM-SM-A100-300 Flexible Cable Assembly 300mm DC- 18GHz SMA Male to SMA Male



SM-SM-A100-500 Flexible Cable Assembly 500mm DC- 18GHz SMA Male to SMA Male



SM-SM-A100-1000 Flexible Cable Assembly 1000mm DC- 18GHz SMA Male to SMA Male



SM-SM-A100-1500 Flexible Cable Assembly 1500mm DC- 18GHz SMA Male to SMA Male



SM-SM-A100-2000 Flexible Cable Assembly 2000mm DC- 18GHz SMA Male to SMA Male



SM-SM-A100-3000 Flexible Cable Assembly 3000mm DC- 18GHz SMA Male to SMA Male



SM-SM-A100-5000 Flexible Cable Assembly 5000mm DC- 18GHz SMA Male to SMA Male



SM-SM-A100-10000 Flexible Cable Assembly 10000mm DC- 18GHz SMA Male to SMA Male

Similar Products



LB-65180-20-A Multi Octave Horn Antenna 6.5-18GHz 20dB Gain Double Ridge Waveguide Interface

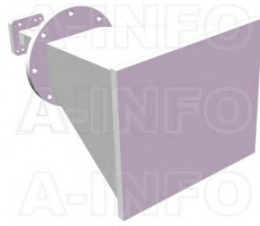

LB-65180-20-ASPO Multi Octave Horn Antenna 6.5-18GHz 20dB Gain Double Ridge Waveguide Interface



LB-65180-20-C-NF Multi Octave Horn Antenna 6.5-18GHz 20dB Gain N Type Female



LB-65180-20-C-NFSPO Multi Octave Horn Antenna 6.5-18GHz 20dB Gain N Type Female



LB-65180-20-C-SF Multi Octave Horn Antenna 6.5-18GHz 20dB Gain SMA Female



LB-65180-20-C-HNF Multi Octave Horn Antenna 6.5-18GHz 20dB Gain High Power N Type Female



LB-65180-20-C-HNFSPO Multi Octave Horn Antenna 6.5-18GHz 20dB Gain High Power N Type Female

About this Datasheet

● **Product Information**

Product Link:
<https://www.ainfoinc.com/lb-65180-20-c-sfspo-multi-octave-horn-antenna-6-5-18-ghz-20db-gain-sma-female>
 Data subject to change without notice.
 © A-INFO INC. 2024. All Rights Reserved

● **Contact Us**

Address:
 60 Tesla, Irvine, CA 92618, USA
 Website:
www.ainfoinc.com
 Email:
sales@ainfoinc.com

● **Phone & Fax**

Phone:
 +1-949-639-9688
 +1-949-639-9608
 Fax:
 +1-949-639-9670