

LB-65180-15-C-ENF Multi Octave Horn Antenna 6.5-18GHz 15dB Gain  
Endlaunch N Type Female

Multi Octave Horn Antenna Operating From 6.5GHz to 18GHz With a  
Nominal 15dB Gain With Endlaunch N Type Female Connector

### Product Information

SKU	LB-65180-15-C-ENF
-----	-------------------

### Description

Multi octave horn antenna LB-65180-15-C-ENF, operating from 6.5 to 18GHz with a nominal 15dB gain and low VSWR 1.5:1 with Endlaunch N Type Female output connector. The model LB-65180-15-C-ENF has uniform gain through its frequency span, providing efficient performance characteristics and directionality. It can handle 150W continuously and 3000W peak power. Constructed of lightweight corrosion-resistant aluminum, the antenna will provide years of trouble-free indoor and outdoor service. This multi octave horn antenna is linearly polarized and ideally suited for EMI testing, direction finding, surveillance, antenna gain and pattern measurements and other applications.

## Technical Specification

Electrical Specification		Interface	
Frequency, Min (GHz)	6.5	Output Type	Coaxial
Frequency, Max (GHz)	18	Connector	N Type
Waveguide Type	Double Ridge	Connector Gender	Female
Waveguide Size EIA WRD	WRD650	Mechanical Specification	
Gain, Typ (dBi)	15	Figure	C Type
Polarization	Linear	Body Material	Al
3dB Beamwidth, E-Plane, Min (Deg.)	18	Finish	Passivation and Chemical Conversion Coating, Gray Paint
3dB Beamwidth, E-Plane, Max (Deg.)	40	Size, W (mm)	78
3dB Beamwidth, H-Plane, Min (Deg.)	16	Size, H (mm)	65.5
3dB Beamwidth, H-Plane, Max (Deg.)	51	Size, L (mm)	172.5
Cross Pol. Isolation, Typ (dB)	40	Weight, (kg)	0.28
VSWR, Typ	1.5:1		
Impedance, (Ohm)	50		
Power Handling, CW, (W)	150		
Power Handling, Peak, (W)	3000		

## Additional Information

Application	General Purpose Indoor & Outdoor, Fixed	Solution for	Gain Reference Antenna Measurement Far-field Measurement System Intergration
-------------	---	--------------	---

## Outline Drawing

Endlaunch N-Female Output (P/N: LB-65180-15-C-ENF)

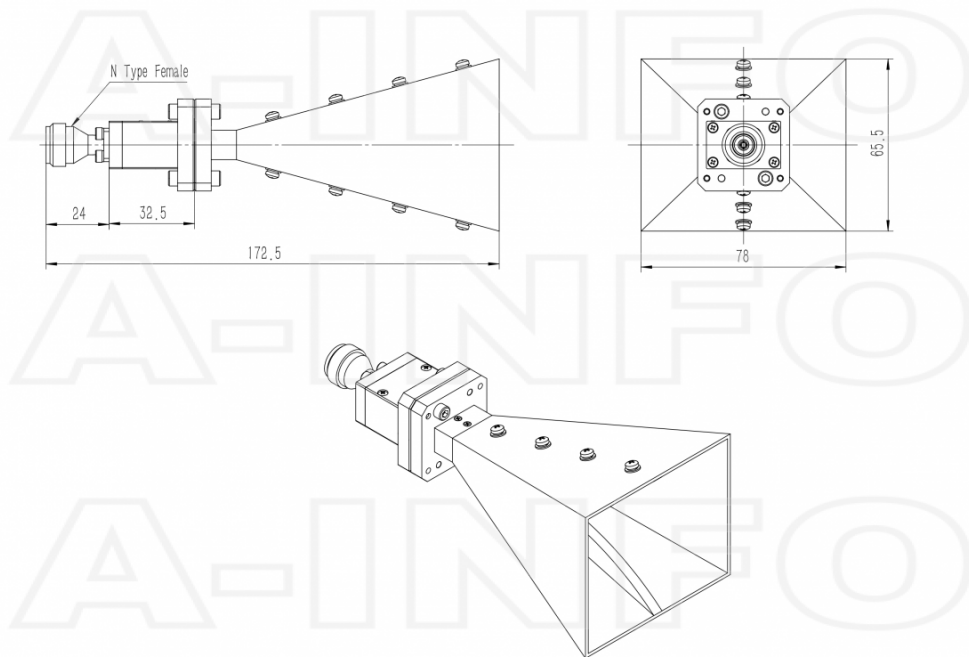

## Typical Test Results

Gain

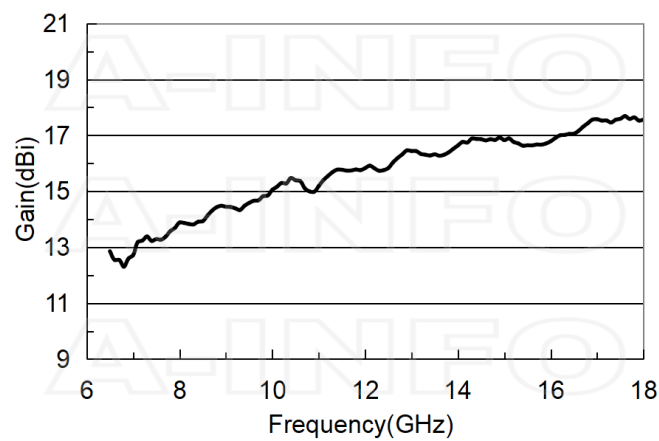

## Antenna Factor

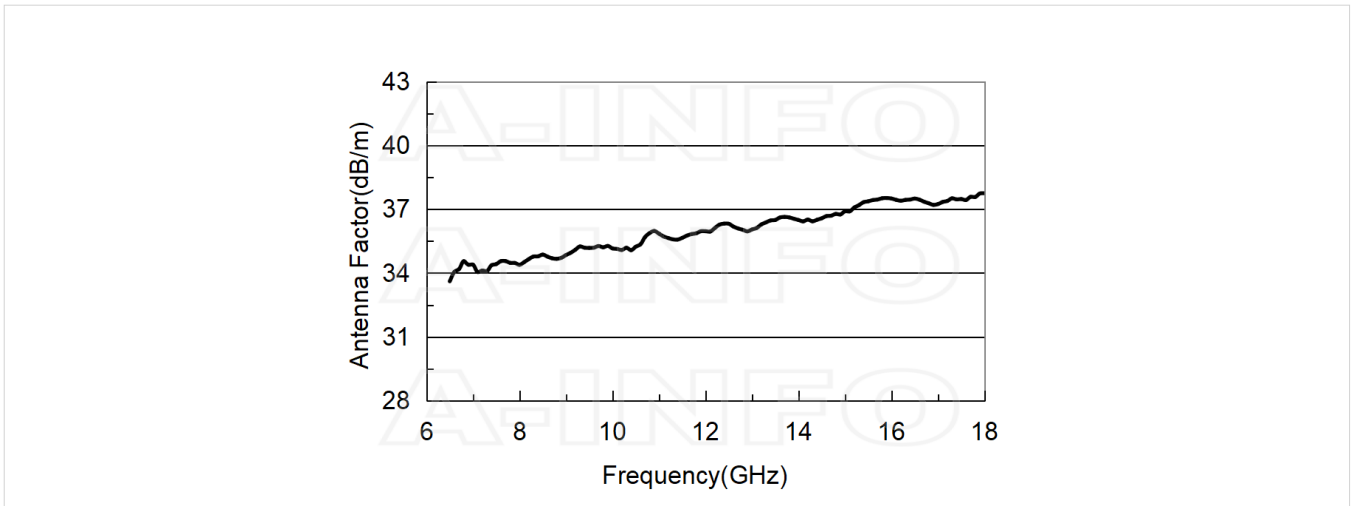

## Antenna Factor (Table)

Frequency(GHz)	Gain(dBi )	Antenna Factor(dB/m)
6.5	12.86	33.61
7.0	12.72	34.39
8.0	13.88	34.39
9.0	14.45	34.85
10.0	15.05	35.16
11.0	15.19	35.85
12.0	15.83	35.97
13.0	16.44	36.05
14.0	16.64	36.49
15.0	16.83	36.90
16.0	16.79	37.50
17.0	17.57	37.24
18.0	17.56	37.75

## Cross Polarization Isolation

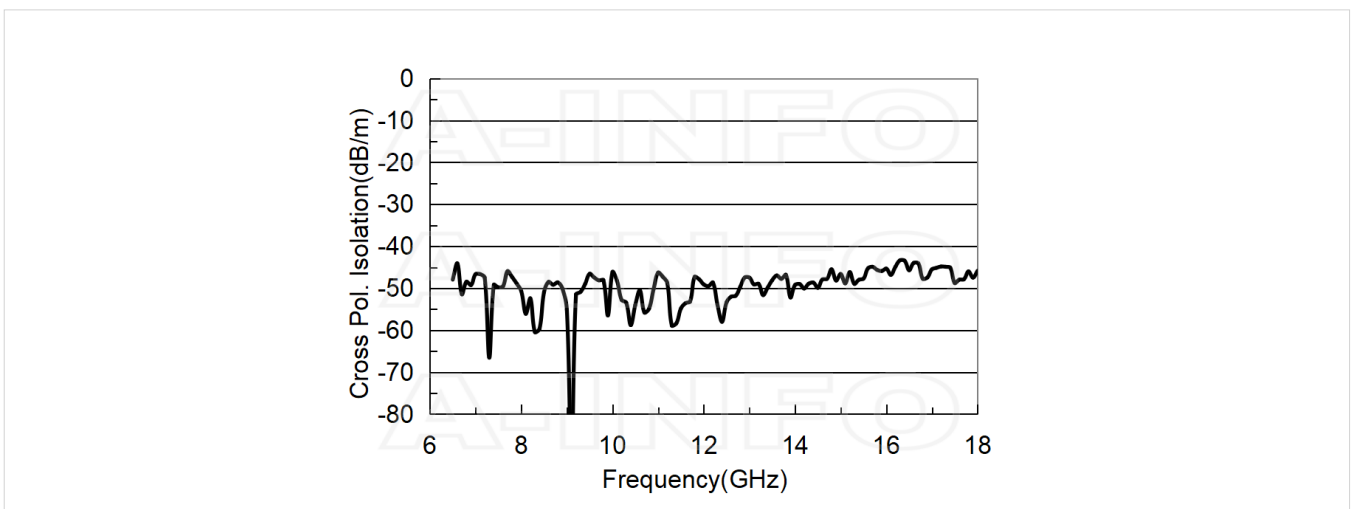

## VSWR

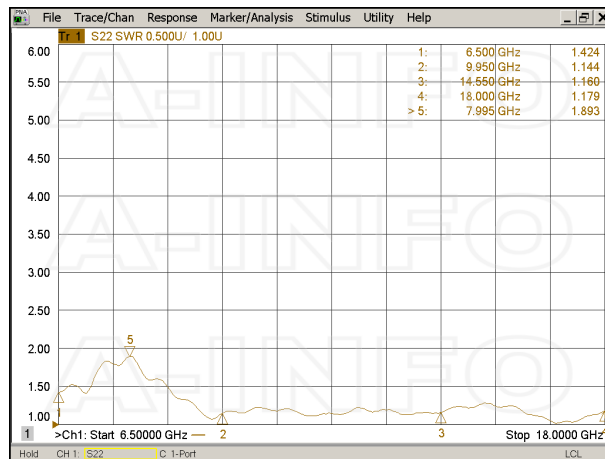

## Beamwidth

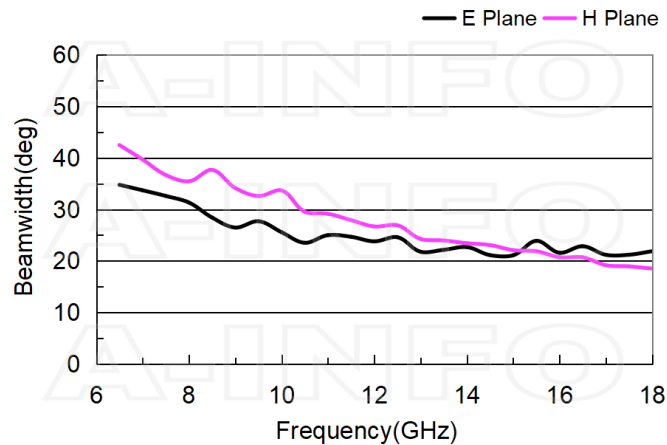

## Pattern

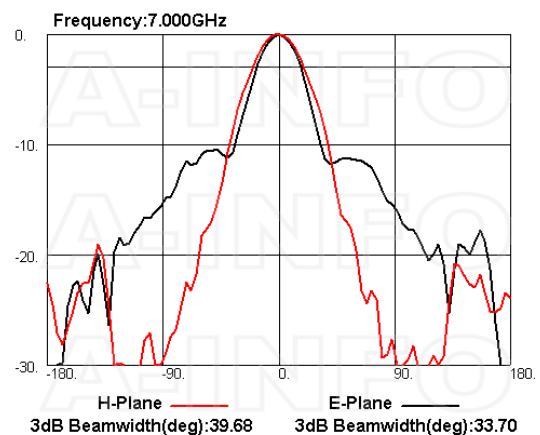
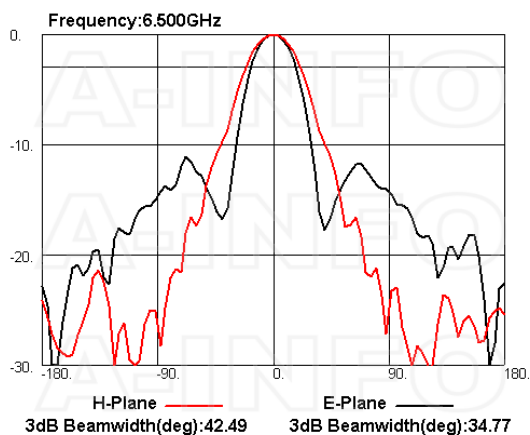

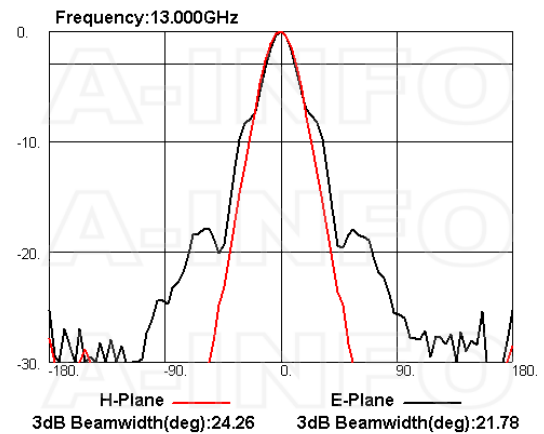
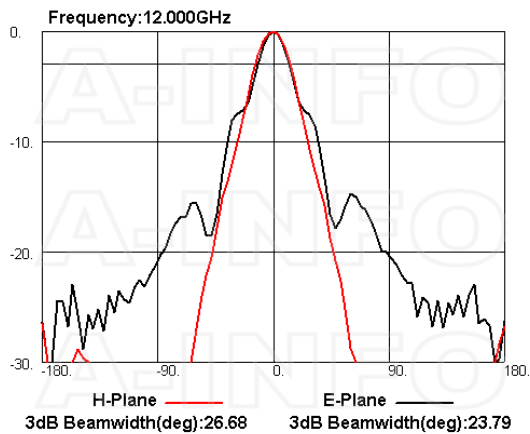
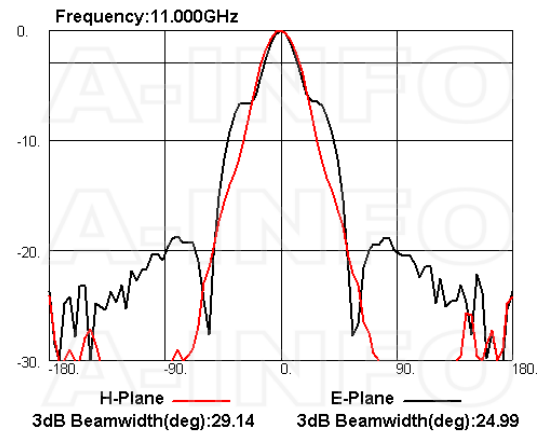
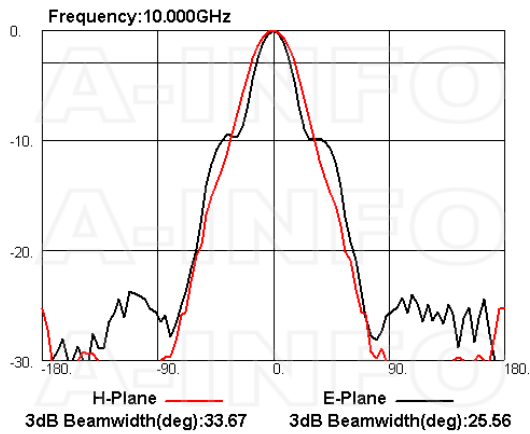
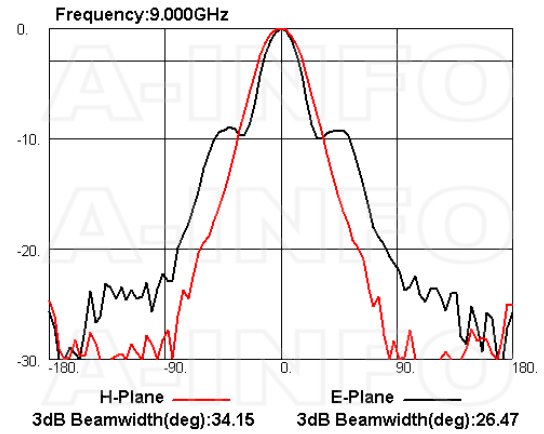
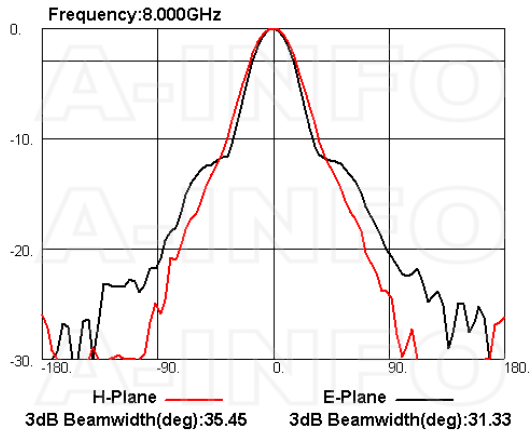

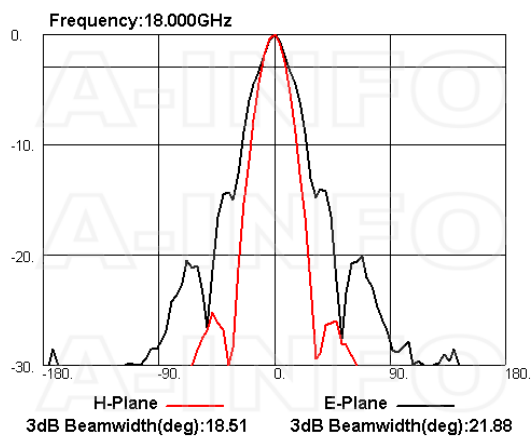
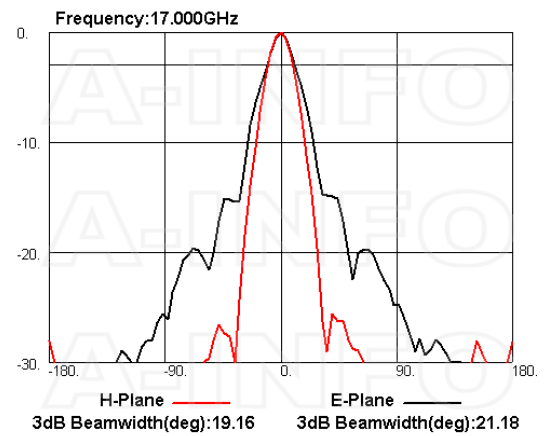
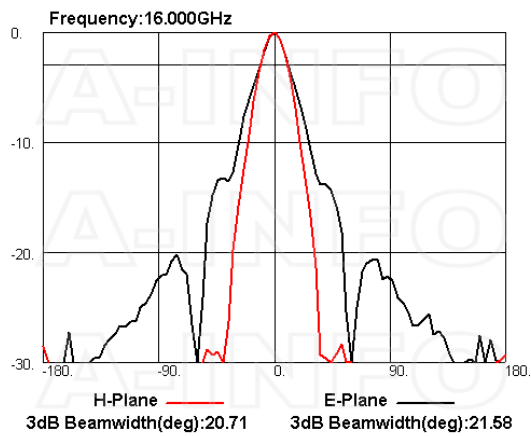
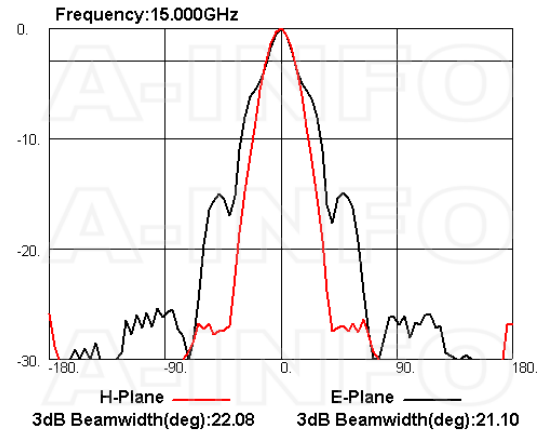
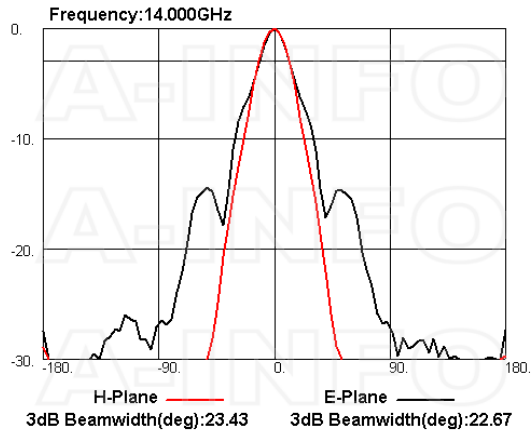

## Related Products



LB-65180-10-C-MB Round Type Mounting Bracket



LB-65180-10-C-MBL L type mounting bracket



Tripod\_15Kg Al Alloy Tripod



3033HL Wooden Tripod



3033QM Wooden Tripod Metalfree



Carrying Case\_LB-65180-15-C Al Alloy Carrying Case



NM-NM-A050-500 Flexible Cable Assembly 500mm DC- 18GHz N Male to N Male



NM-NM-A050-1000 Flexible Cable Assembly 1000mm DC- 18GHz N Male to N Male



NM-NM-A050-1500 Flexible Cable Assembly 1500mm DC- 18GHz N Male to N Male



NM-NM-A050-2000 Flexible Cable Assembly 2000mm DC- 18GHz N Male to N Male



NM-NM-A050-3000 Flexible Cable Assembly 3000mm DC- 18GHz N Male to N Male



NM-NM-A050-5000 Flexible Cable Assembly 5000mm DC- 18GHz N Male to N Male



NM-NM-A050-10000 Flexible Cable Assembly 10000mm DC- 18GHz N Male to N Male



NM-NM-A050-20000 Flexible Cable Assembly 20000mm DC- 18GHz N Male to N Male



NM-NM-A100-500 Flexible Cable Assembly 500mm DC- 18GHz N Male to N Male



NM-NM-A100-1000 Flexible Cable Assembly 1000mm DC- 18GHz N Male to N Male



NM-NM-A100-1500 Flexible Cable Assembly 1500mm DC-18GHz N Male to N Male



NM-NM-A100-2000 Flexible Cable Assembly 2000mm DC-18GHz N Male to N Male



NM-NM-A100-3000 Flexible Cable Assembly 3000mm DC-18GHz N Male to N Male



NM-NM-A100-5000 Flexible Cable Assembly 5000mm DC-18GHz N Male to N Male



NM-NM-A100-10000 Flexible Cable Assembly 10000mm DC-18GHz N Male to N Male



NM-NM-A100-20000 Flexible Cable Assembly 20000mm DC-18GHz N Male to N Male

## About this Datasheet

<ul style="list-style-type: none"> <li>● <b>Product Information</b> Product Link: <a href="https://www.ainfoinc.com/lb-65180-15-c-enf-multi-octave-horn-antenna-6-5-18-ghz-15db-gain-endlaunch-n-type-female">https://www.ainfoinc.com/lb-65180-15-c-enf-multi-octave-horn-antenna-6-5-18-ghz-15db-gain-endlaunch-n-type-female</a> Data subject to change without notice. © A-INFO INC. 2024. All Rights Reserved</li> </ul>	<ul style="list-style-type: none"> <li>● <b>Contact Us</b> Address: 60 Tesla, Irvine, CA 92618, USA Website: <a href="http://www.ainfoinc.com">www.ainfoinc.com</a> Email: <a href="mailto:sales@ainfoinc.com">sales@ainfoinc.com</a></li> </ul>	<ul style="list-style-type: none"> <li>● <b>Phone &amp; Fax</b> Phone: +1-949-639-9688 +1-949-639-9608 Fax: +1-949-639-9670</li> </ul>
---	--	--