

### LB-60180-20-A Multi Octave Horn Antenna 6-18GHz 20dB Gain Double Ridge Waveguide Interface



Multi Octave Horn Antenna From 6GHz to 18GHz With a Nominal 20dB Gain With Double Ridge Waveguide Interface

## Product Information

SKU	LB-60180-20-A
-----	---------------

## Description

Multi octave horn antenna LB-60180-20-A, operating from 6 to 18GHz with a nominal 20dB gain and low VSWR 1.5:1 with FPWRD650D28 output. The model LB-60180-20-A has uniform gain through its frequency span, providing efficient performance characteristics and directionality. Constructed of lightweight corrosion-resistant aluminum, the antenna will provide years of trouble-free indoor and outdoor service. This multi octave horn antenna is linearly polarized and ideally suited for EMI testing, direction finding, surveillance, antenna gain and pattern measurements and other applications.

## Technical Specification

Electrical Specification		Interface	
Frequency, Min (GHz)	6	Output Type	Waveguide
Frequency, Max (GHz)	18	Flange Designation, WRD	FPWRD650D28
Waveguide Type	Double Ridge	Connector Gender	N/A
Waveguide Size EIA WRD	WRD650	Mechanical Specification	
Gain, Typ (dBi)	20	Figure	A Type
Polarization	Linear	Body Material	Al
3dB Beamwidth, E-Plane, Min (Deg.)	7	Finish	Chemical Conversion Coating, Gray Paint
3dB Beamwidth, E-Plane, Max (Deg.)	29	Size, W (mm)	124
3dB Beamwidth, H-Plane, Min (Deg.)	8	Size, H (mm)	104
3dB Beamwidth, H-Plane, Max (Deg.)	32	Size, L (mm)	226
Cross Pol. Isolation, Typ (dB)	40	Weight, (kg)	0.4
VSWR, Typ	1.5:1		

## Additional Information

Application	General Purpose Indoor & Outdoor, Fixed	Solution for	Gain Reference Antenna Measurement Far-field Measurement System Intergration
-------------	---	--------------	---

## Outline Drawing

FPWRD650D28 Output (P/N: LB-60180-20-A)

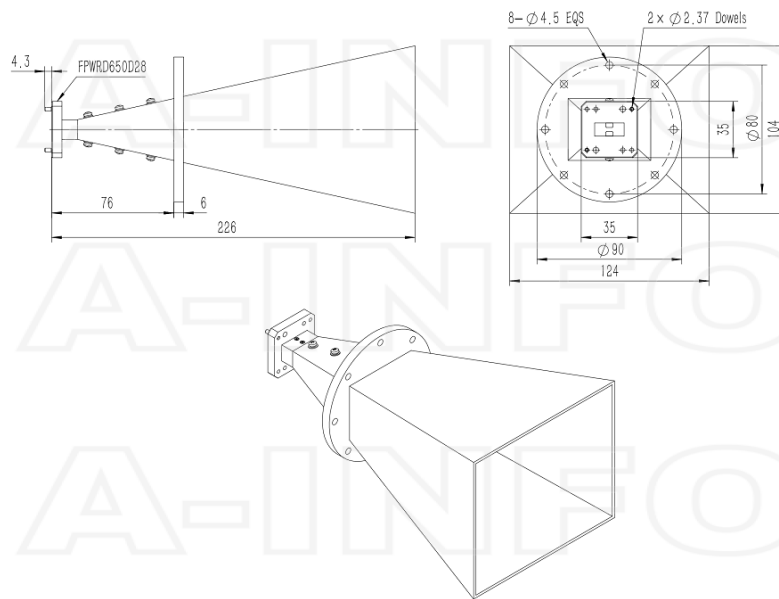

Flange Drawing

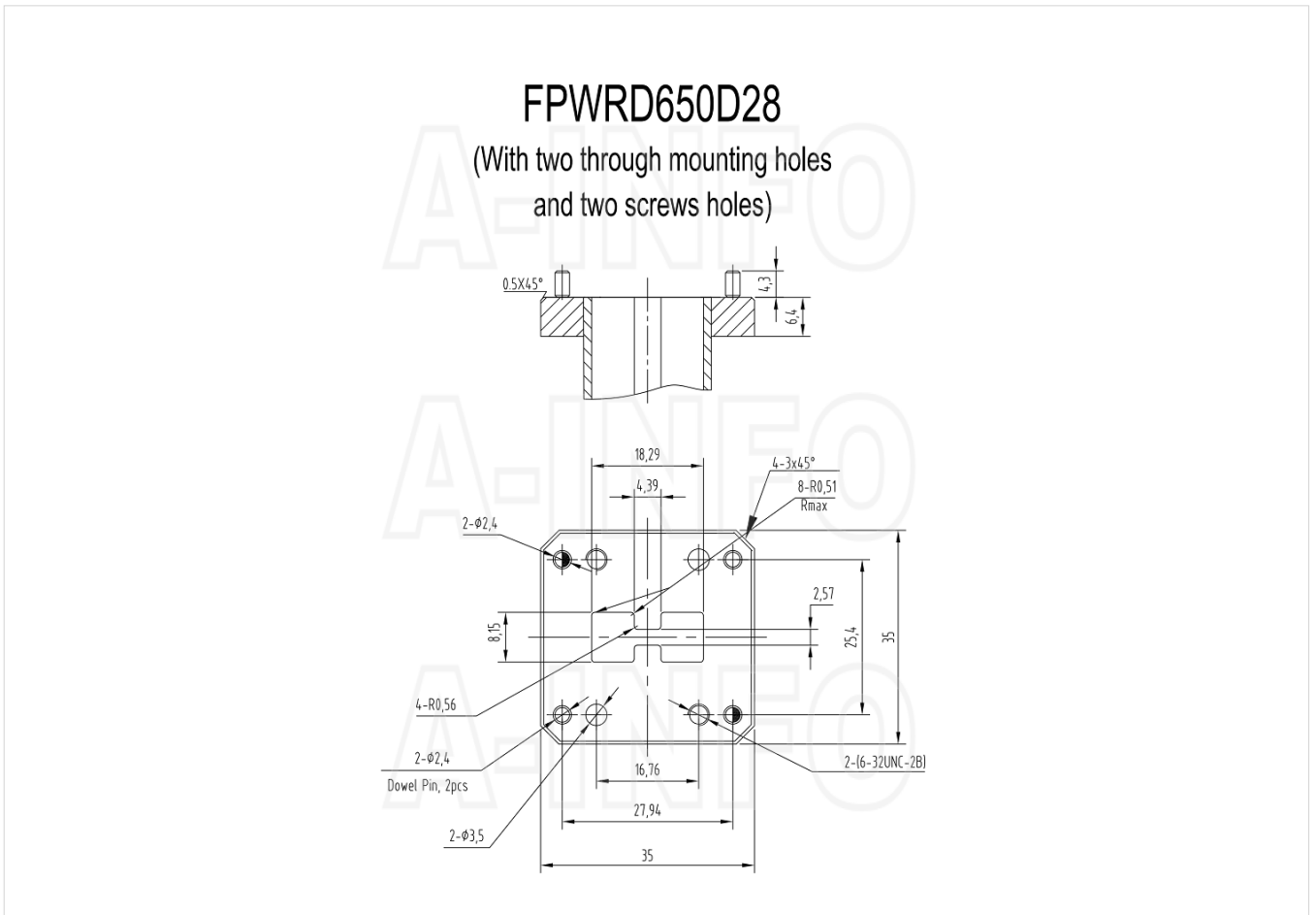

Typical Test Results

Gain

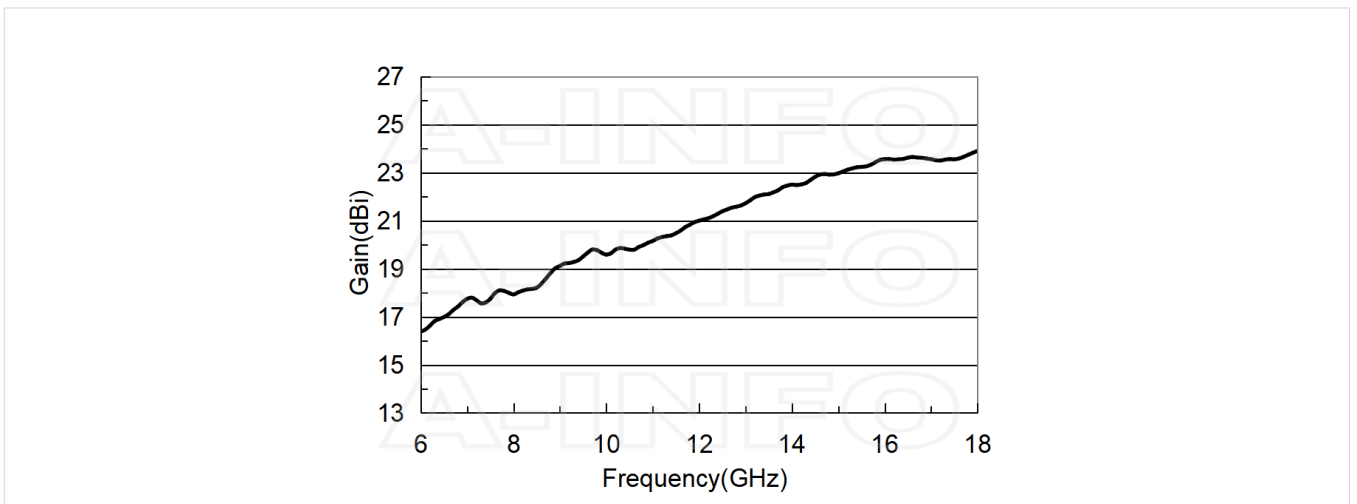

## Antenna Factor

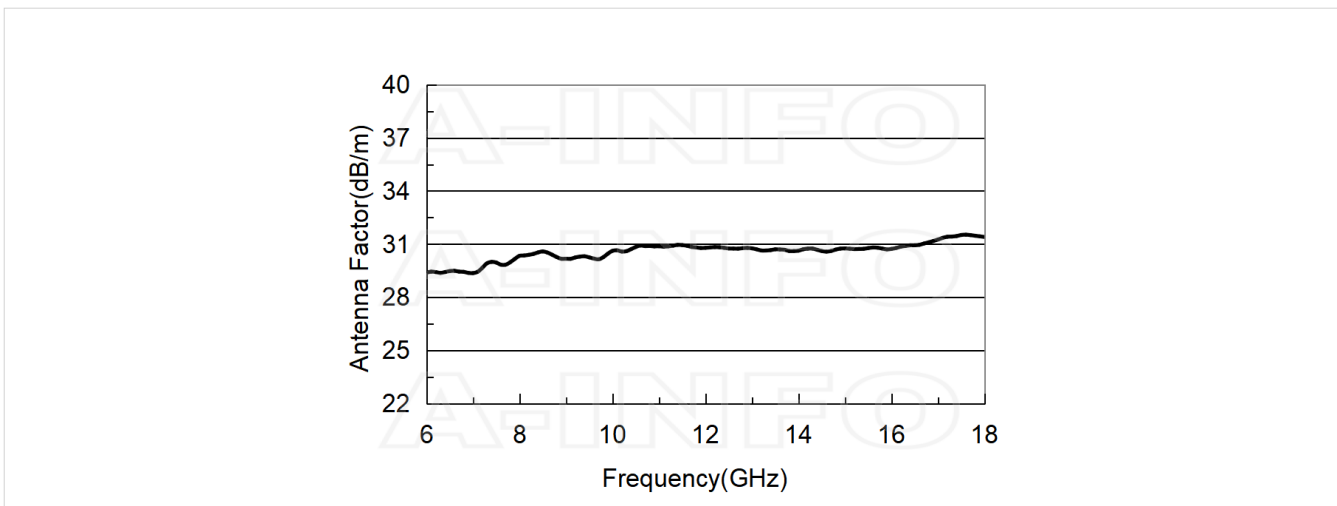

## Antenna Factor (Table)

Frequency(GHz)	Gain(dBi)	AF(dB/m)
6.0	16.38	29.39
7.0	17.75	29.37
8.0	17.93	30.34
9.0	19.12	30.18
10.0	19.59	30.62
11.0	20.16	30.88
12.0	21.00	30.79
13.0	21.73	30.76
14.0	22.50	30.63
15.0	22.97	30.76
16.0	23.56	30.73
17.0	23.56	31.26
18.0	23.91	31.41

## Cross Polarization Isolation

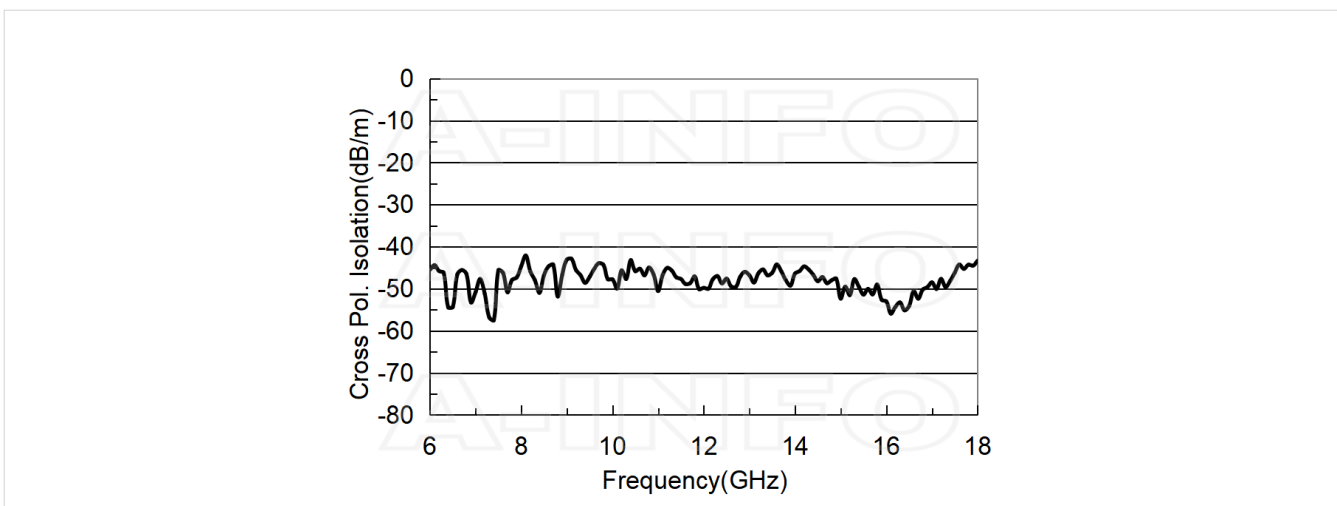

## VSWR

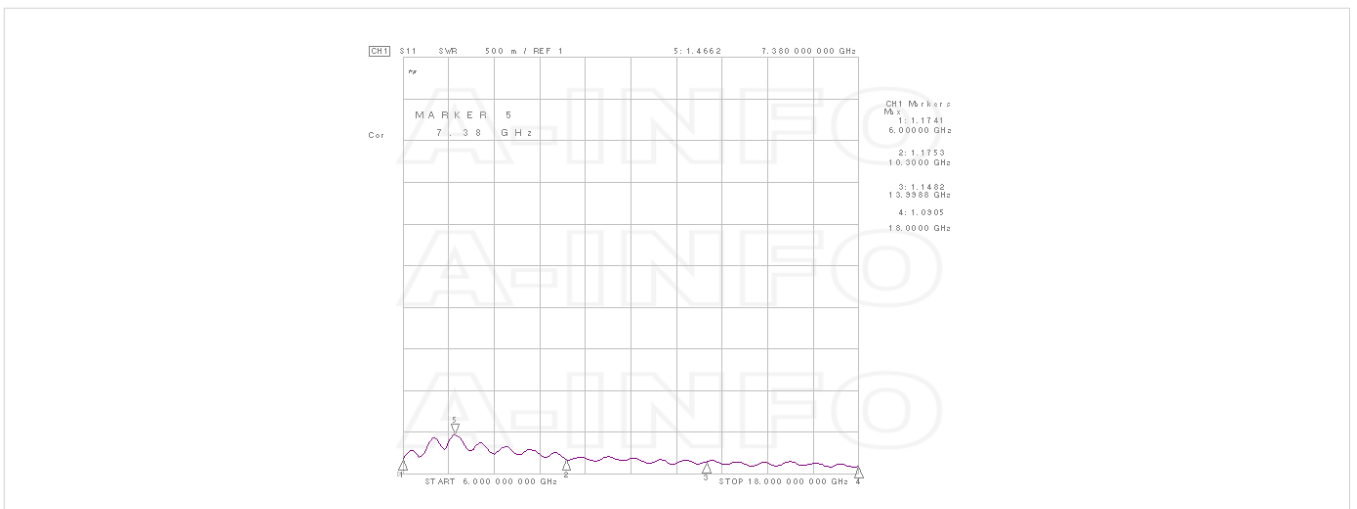

## Beamwidth

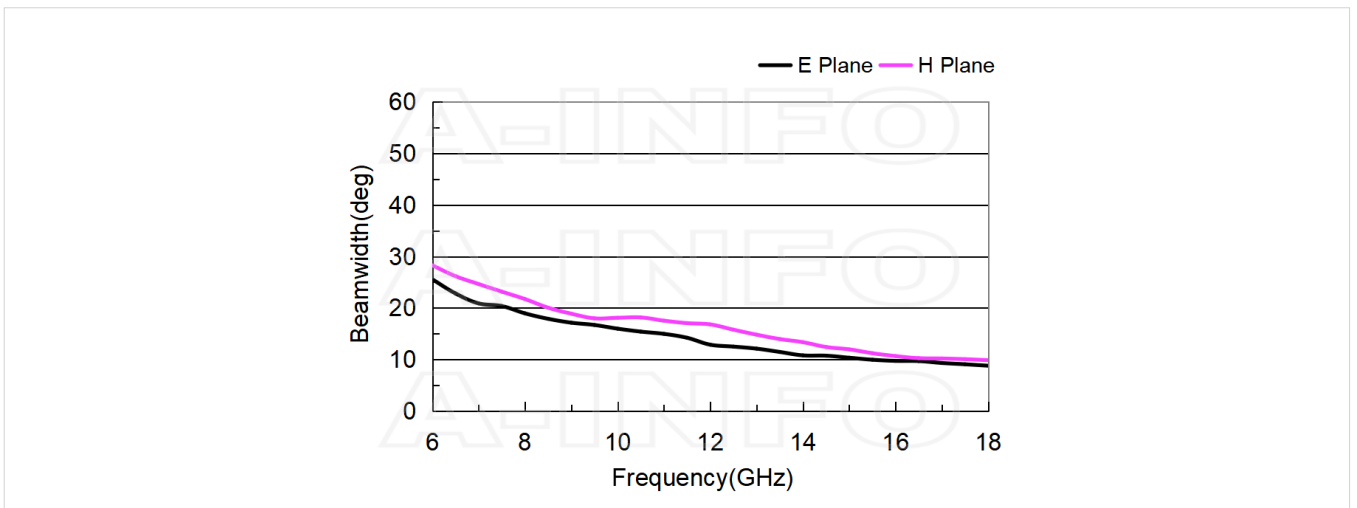

## Pattern

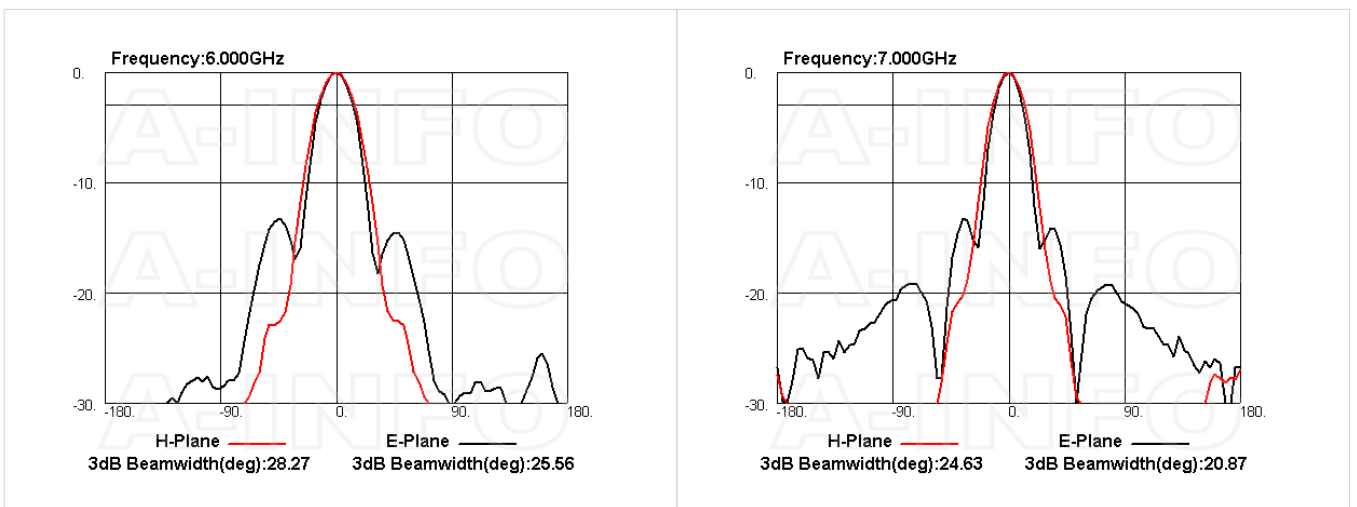

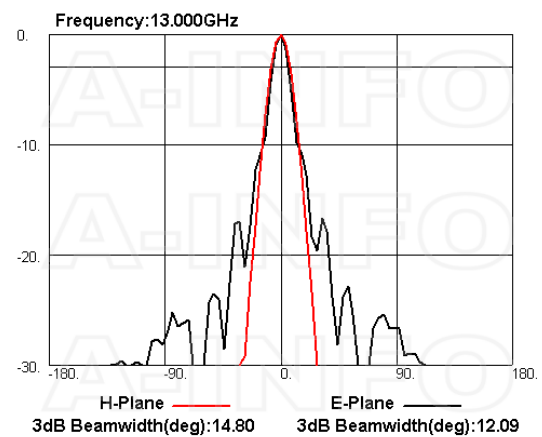
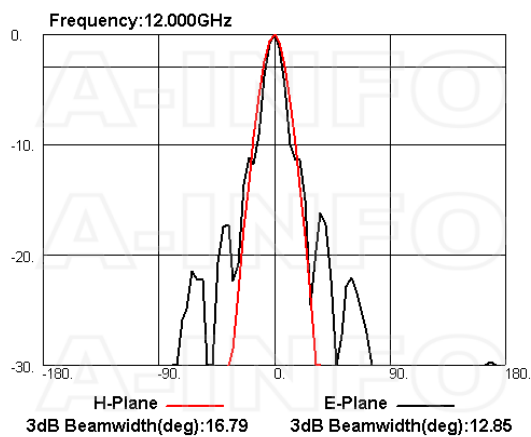
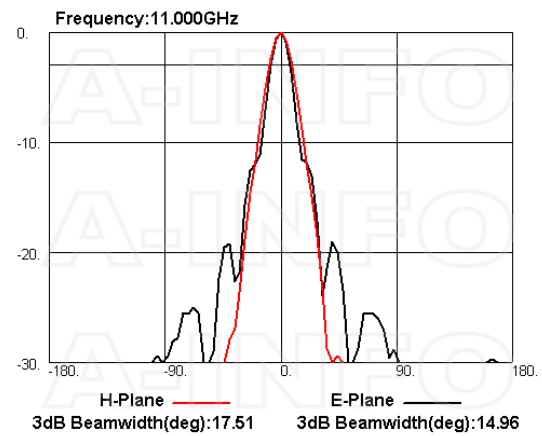
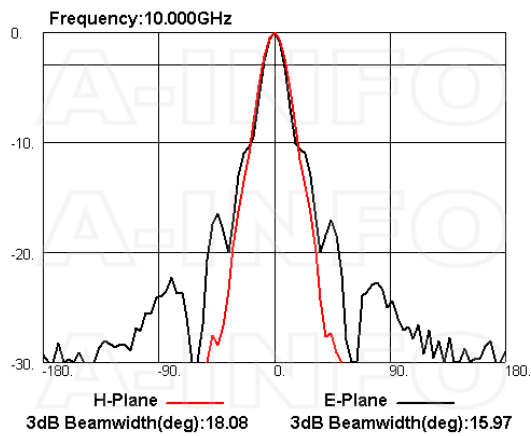
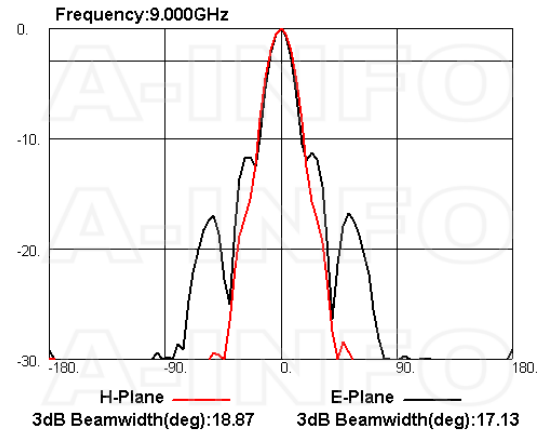
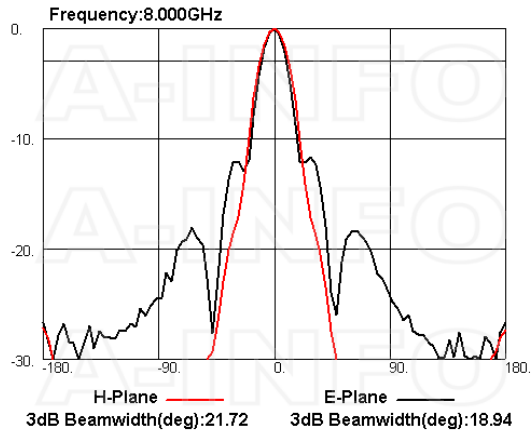

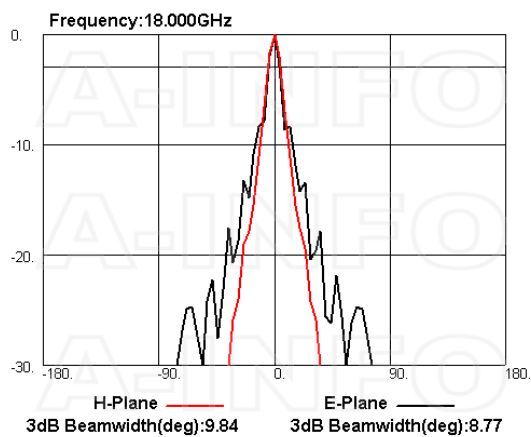
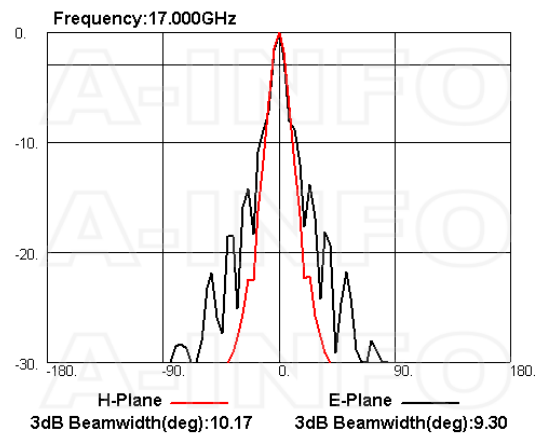
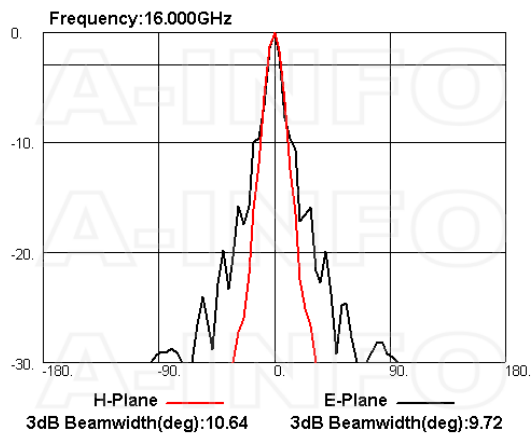
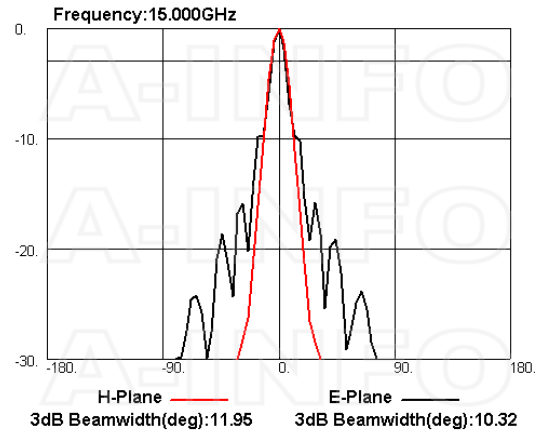
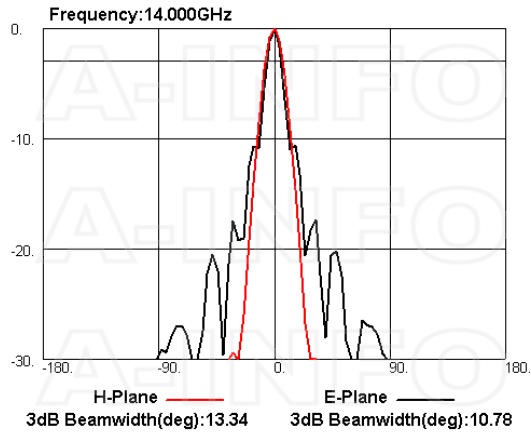

## Related Products



650DRWCAN\_Cu Right Angle Double Ridge Waveguide to Coaxial Adapter 6.5-18GHz WRD650 to N Type Female



650DRWCAS\_Cu Right Angle Double Ridge Waveguide to Coaxial Adapter 6.5-18GHz WRD650 to SMA Female



650DRWECAN\_Cu Endlaunch Double Ridge Waveguide to Coaxial Adapter 6.5-18GHz WRD650 to N Type Female



650DRWECANM\_Cu Endlaunch Double Ridge Waveguide to Coaxial Adapter 6.5-18GHz WRD650 to N Type Male



650DRWECAS\_Cu Endlaunch Double Ridge Waveguide to Coaxial Adapter 6.5-18GHz WRD650 to SMA Female



650DRWHCAN\_Cu Right Angle High Power Double Ridge Waveguide to Coaxial Adapter 6.5-18GHz WRD650 to N Type Female



LB-65180-20-C-MB Round Type Mounting Bracket



LB-65180-20-C-L L type mounting bracket



Tripod\_15Kg Al Alloy Tripod



3033HL Wooden Tripod



3033QM Wooden Tripod Metalfree



Carrying Case\_LB-65180-20-C Al Alloy Carrying Case

## Similar Products

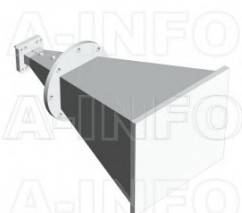

LB-60180-20-ASPO Multi Octave Horn Antenna 6-18GHz 20dB Gain Double Ridge Waveguide Interface



LB-60180-20-C-NF Multi Octave Horn Antenna 6-18GHz 20dB Gain N Type Female



LB-60180-20-C-NFSPO Multi Octave Horn Antenna 6-18GHz 20dB Gain N Type Female



LB-60180-20-C-SF Multi Octave Horn Antenna 6-18GHz 20dB Gain SMA Female



LB-60180-20-C-SFSPO Multi Octave Horn Antenna 6-18GHz 20dB Gain SMA Female



LB-60180-20-C-HNF Multi Octave Horn Antenna 6-18GHz 20dB Gain High Power N Type Female



LB-60180-20-C-HNFSPO Multi Octave Horn Antenna 6-18GHz 20dB Gain High Power N Type Female

## About this Datasheet

<ul style="list-style-type: none"> <li>• <b>Product Information</b> Product Link: <a href="https://www.ainfoinc.com/lb-60180-20-a-multi-octave-horn-antenna-6-18-ghz-20db-gain-fpwr650d28">https://www.ainfoinc.com/lb-60180-20-a-multi-octave-horn-antenna-6-18-ghz-20db-gain-fpwr650d28</a> Data subject to change without notice. © A-INFO INC. 2024. All Rights Reserved</li> </ul>	<ul style="list-style-type: none"> <li>• <b>Contact Us</b> Address: 60 Tesla, Irvine, CA 92618, USA Website: <a href="http://www.ainfoinc.com">www.ainfoinc.com</a> Email: <a href="mailto:sales@ainfoinc.com">sales@ainfoinc.com</a></li> </ul>	<ul style="list-style-type: none"> <li>• <b>Phone &amp; Fax</b> Phone: +1-949-639-9688 +1-949-639-9608 Fax: +1-949-639-9670</li> </ul>
---	--	--