

LB-60180-10-A Multi Octave Horn Antenna 6.0-18.0GHz 10dB Gain Double Ridge Waveguide Interface



Multi Octave Horn Antenna From 6.0GHz to 18.0GHz With a Nominal 10dB Gain With Double Ridge Waveguide Interface

Product Information

SKU	LB-60180-10-A
-----	---------------

Description

Multi octave horn antenna LB-60180-10-A, operating from 6.0 to 18.0GHz with a nominal 10dB gain and low VSWR 1.5:1 with FPWRD650D28 output. The model LB-60180-10-A has uniform gain through its frequency span, providing efficient performance characteristics and directionality. Constructed of lightweight corrosion-resistant aluminum, the antenna will provide years of trouble-free indoor and outdoor service. This multi octave horn antenna is linearly polarized and ideally suited for EMI testing, direction finding, surveillance, antenna gain and pattern measurements and other applications.

Technical Specification

Electrical Specification		Interface	
Frequency, Min (GHz)	6	Output Type	Waveguide
Frequency, Max (GHz)	18	Flange Designation, WRD	FPWRD650D28
Waveguide Type	Double Ridge	Connector Gender	N/A
Waveguide Size EIA WRD	WRD650	Mechanical Specification	
Gain, Typ (dBi)	10	Figure	A Type
Polarization	Linear	Body Material	Al
3dB Beamwidth, E-Plane, Min (Deg.)	21	Finish	Nickel Plated, Gray Paint
3dB Beamwidth, E-Plane, Max (Deg.)	67	Size, W (mm)	55
3dB Beamwidth, H-Plane, Min (Deg.)	22	Size, H (mm)	44
3dB Beamwidth, H-Plane, Max (Deg.)	64	Size, L (mm)	73
Cross Pol. Isolation, Typ (dB)	40	Weight, (kg)	0.06
VSWR, Typ	1.5:1		

Additional Information

Application	General Purpose Indoor & Outdoor, Fixed	Solution for	Gain Reference Antenna Measurement Far-field Measurement System Intergration
-------------	---	--------------	---

Outline Drawing

FPWRD650D28 Output (P/N: LB-60180-10-A)

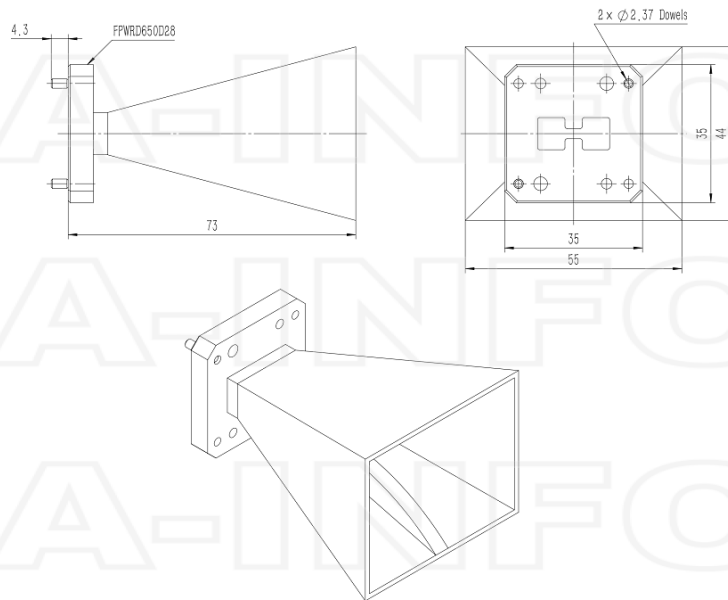

Flange Drawing

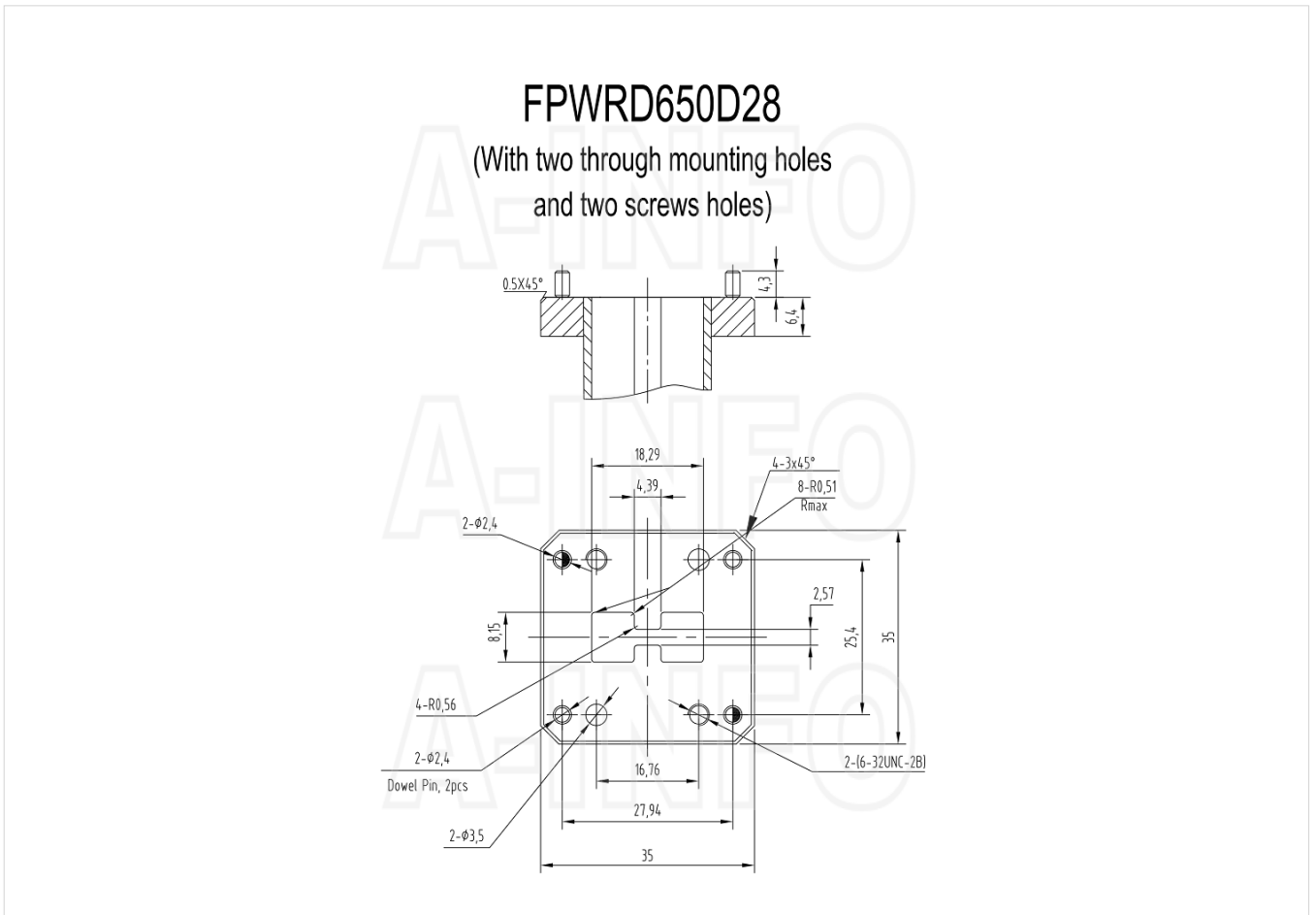

Typical Test Results

Gain

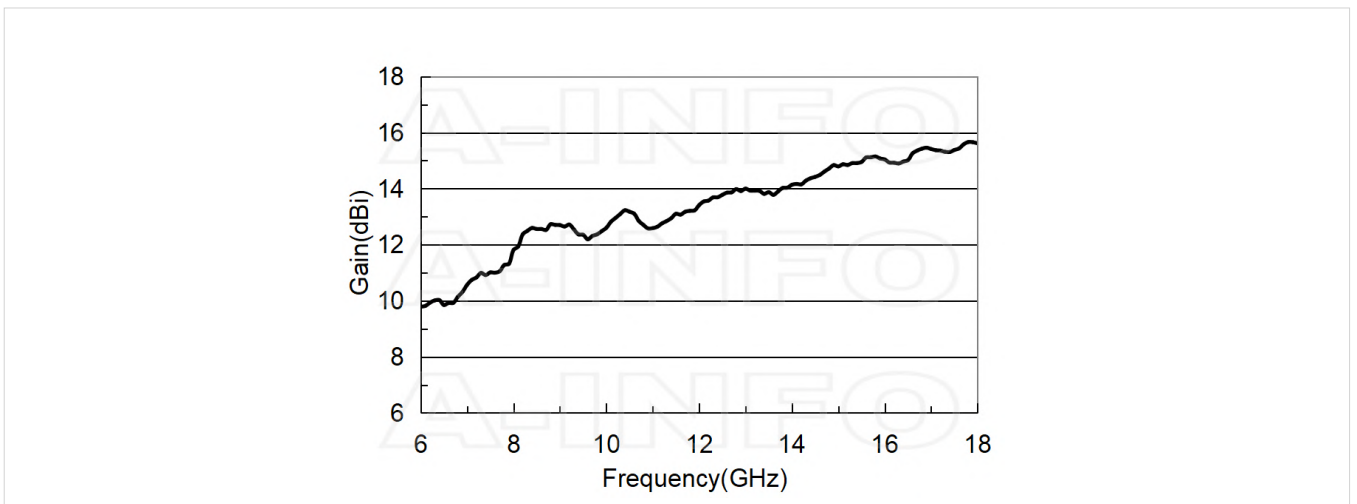

Antenna Factor

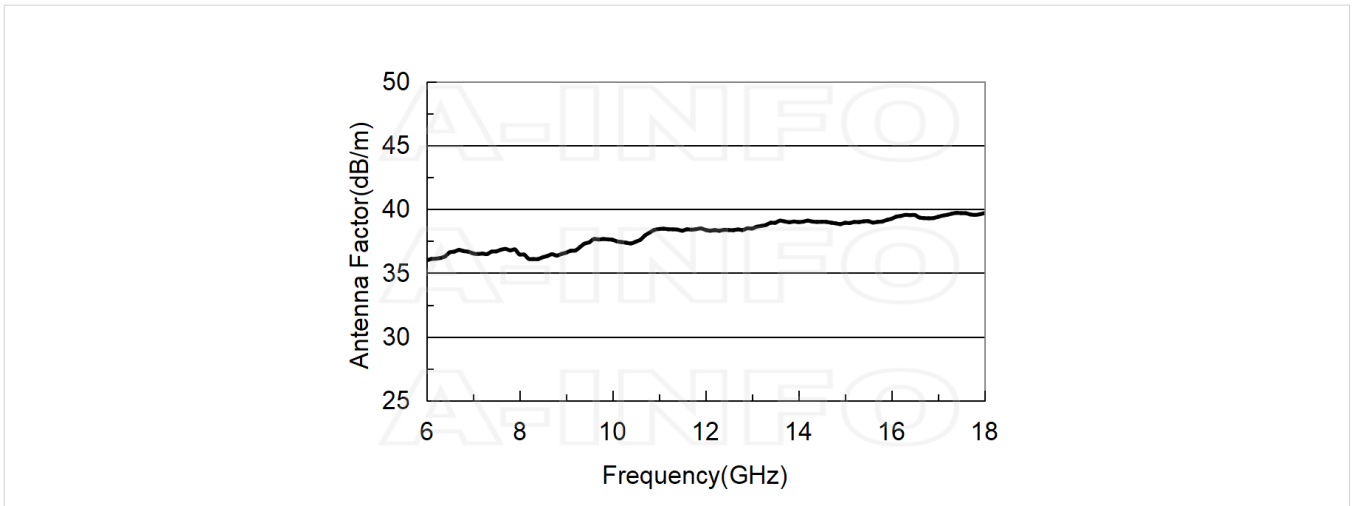

Antenna Factor (Table)

Frequency(GHz)	Gain(dBi)	Antenna Factor(dB/m)
6.0	9.79	35.99
7.0	10.57	36.54
8.0	11.81	36.46
9.0	12.70	36.59
10.0	12.60	37.61
11.0	12.59	38.45
12.0	13.41	38.38
13.0	14.00	38.49
14.0	14.14	38.99
15.0	14.80	38.94
16.0	15.04	39.25
17.0	15.41	39.41
18.0	15.62	39.70

Cross Polarization Isolation

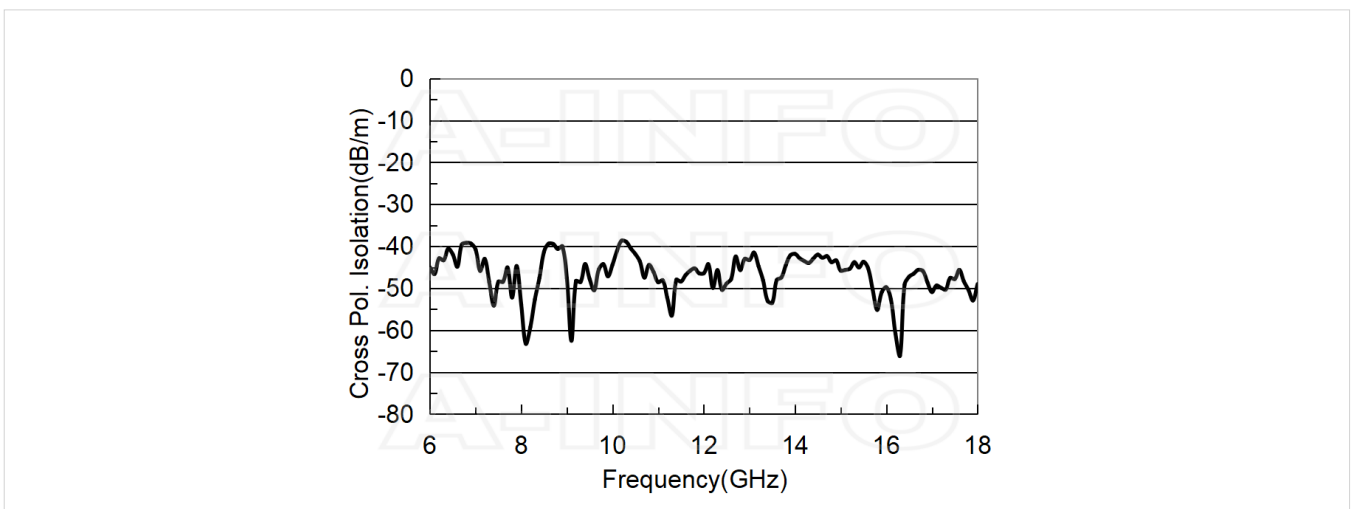

VSWR

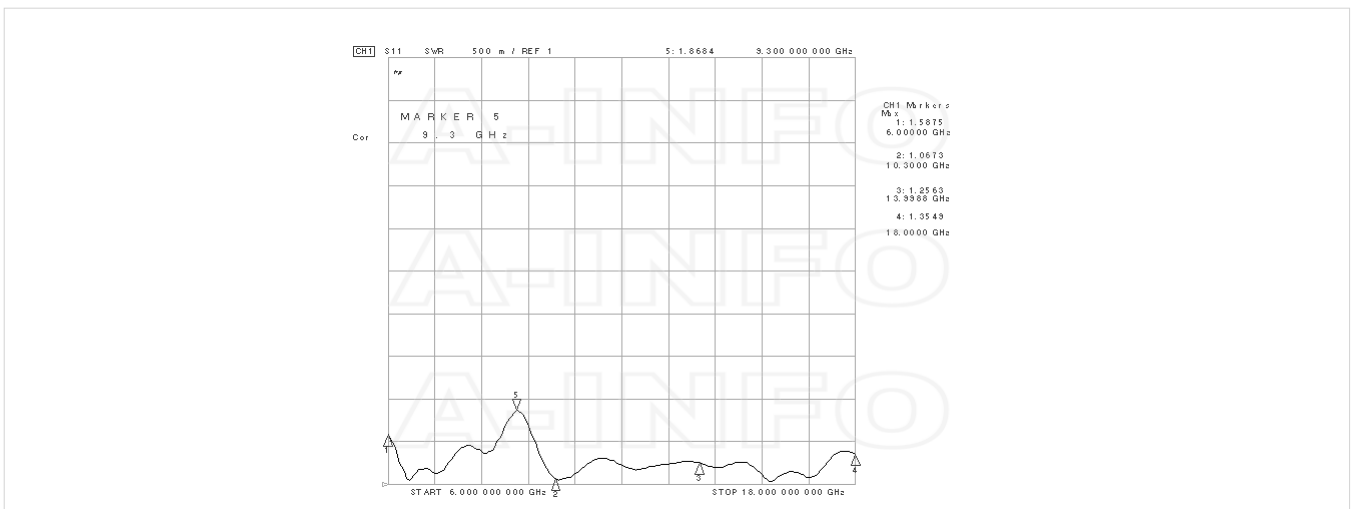

Beamwidth

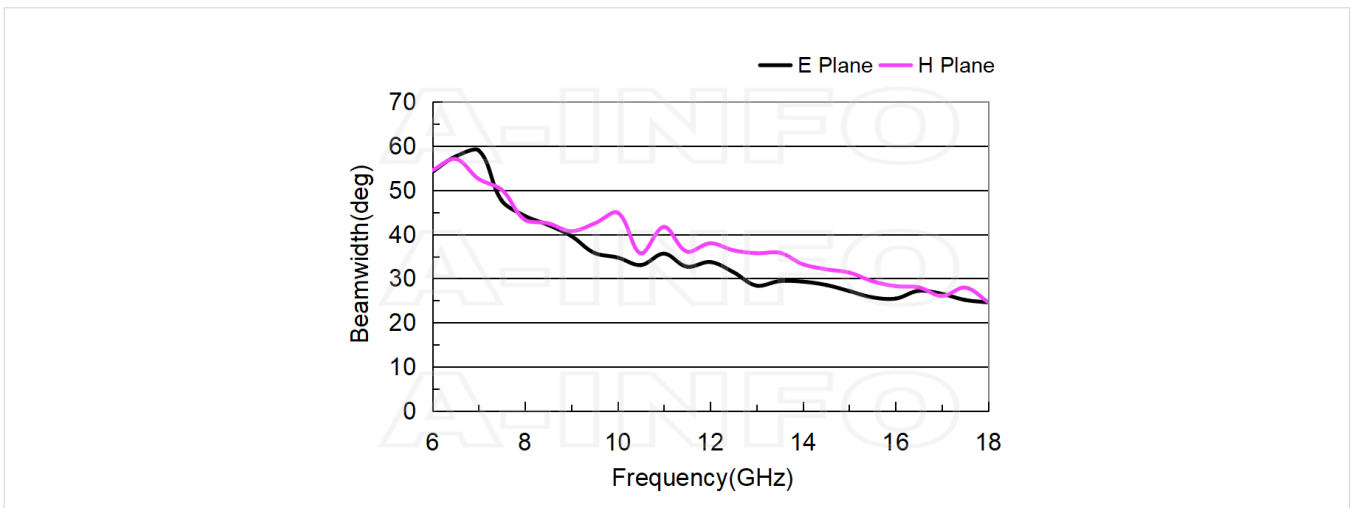

Pattern

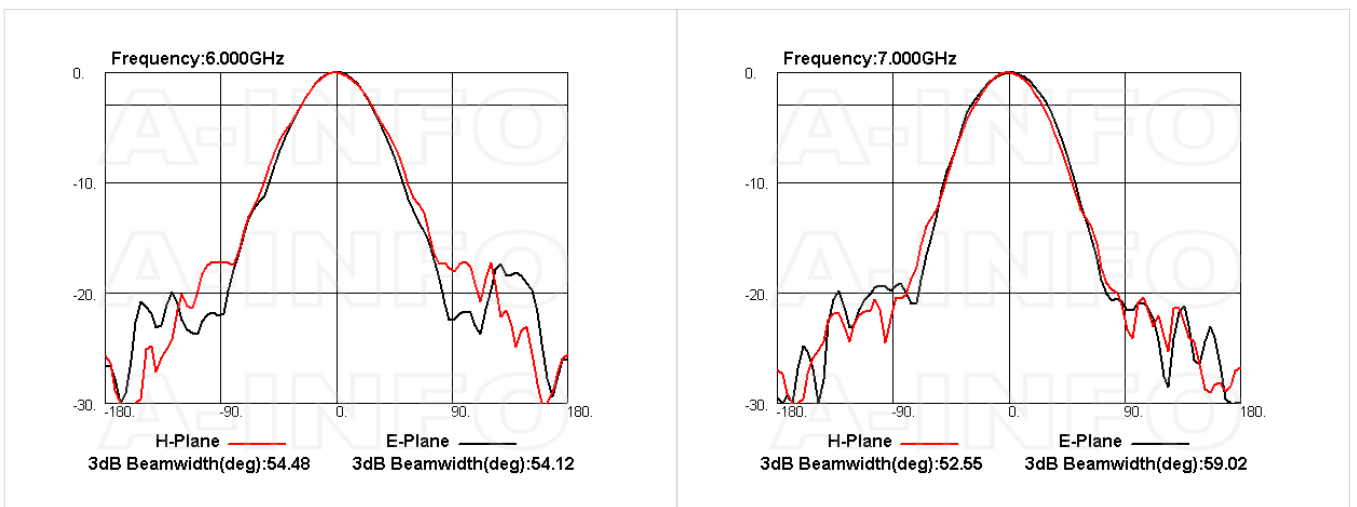

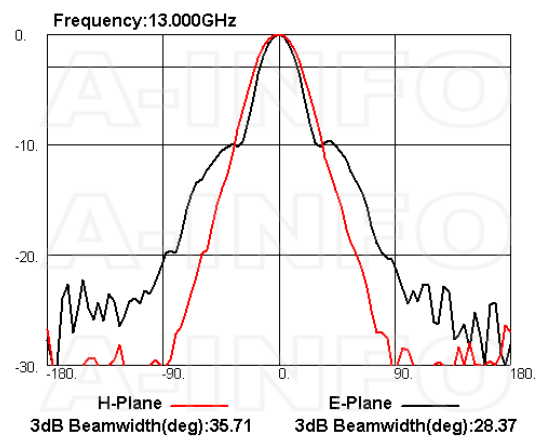
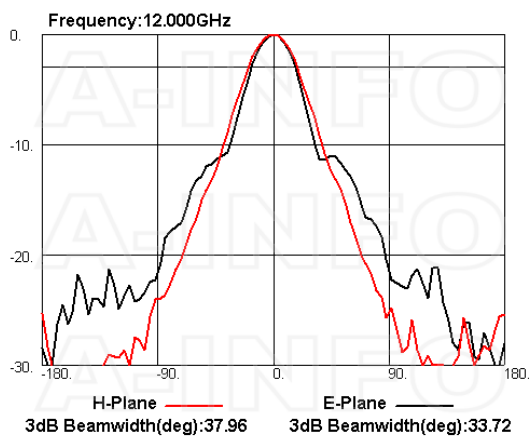
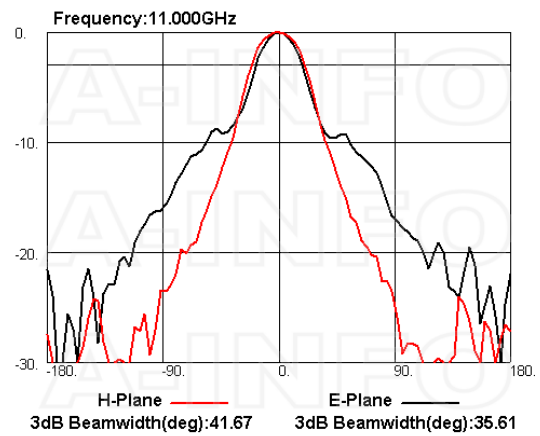
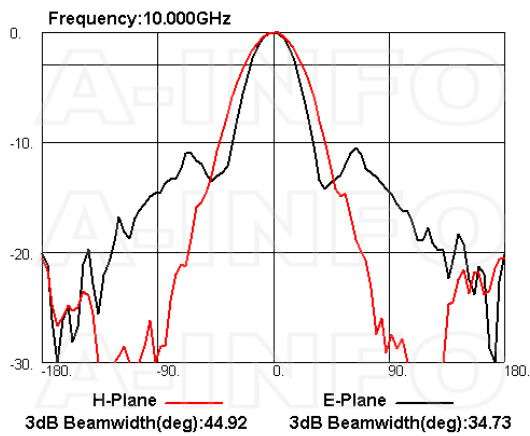
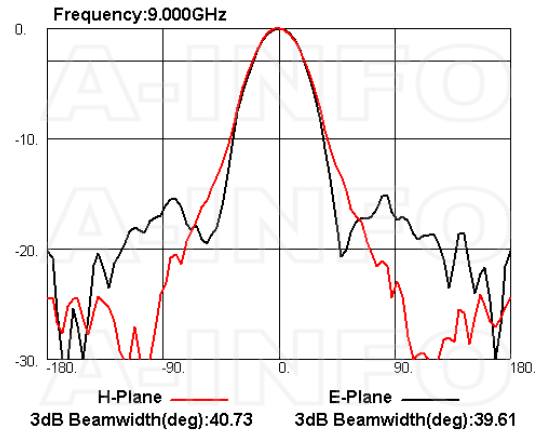
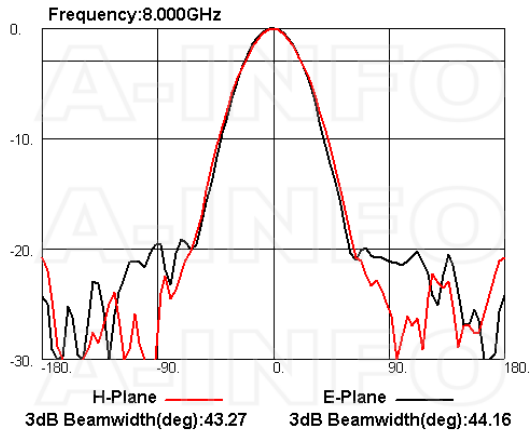

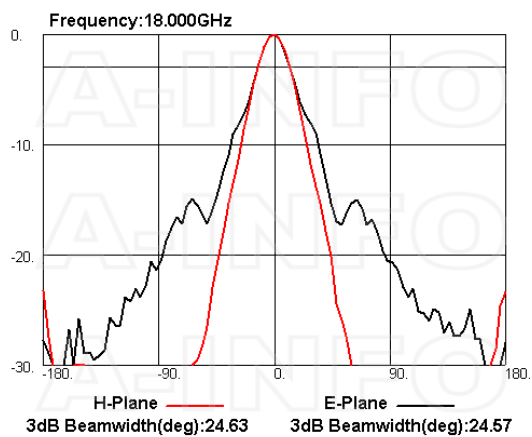
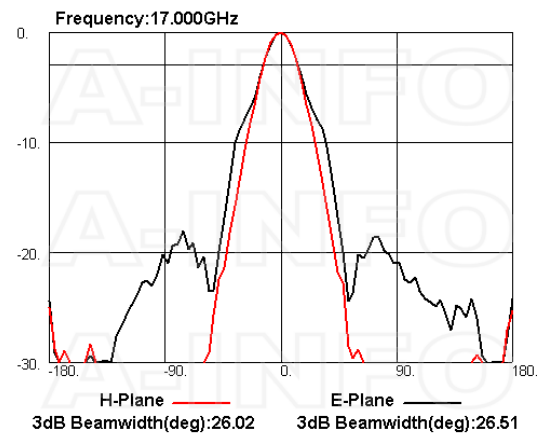
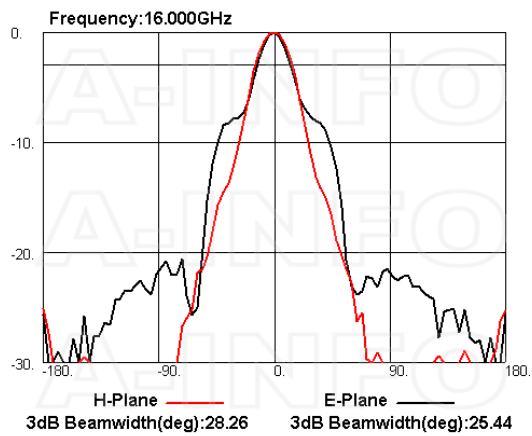
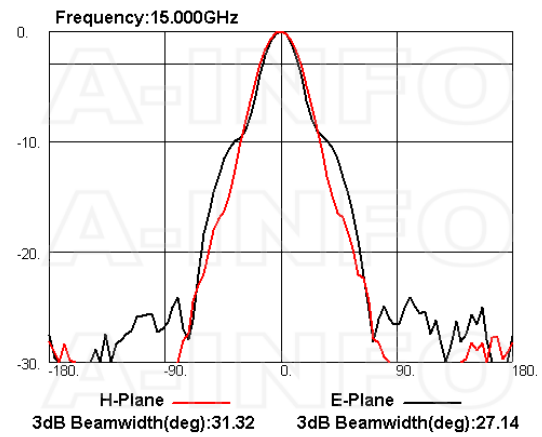
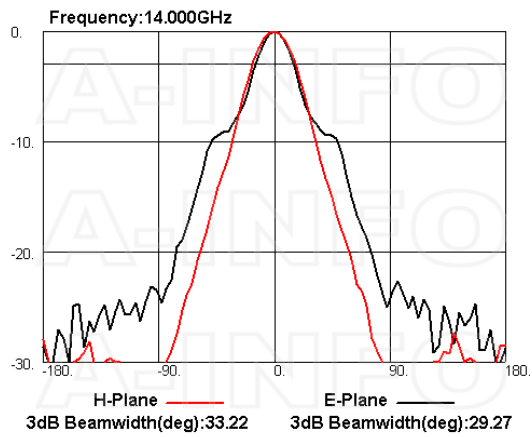

Related Products



650DRWCAN_Cu Right Angle Double Ridge Waveguide to Coaxial Adapter 6.5-18GHz WRD650 to N Type Female



650DRWCAS_Cu Right Angle Double Ridge Waveguide to Coaxial Adapter 6.5-18GHz WRD650 to SMA Female



650DRWECAN_Cu Endlaunch Double Ridge Waveguide to Coaxial Adapter 6.5-18GHz WRD650 to N Type Female



650DRWECANM_Cu Endlaunch Double Ridge Waveguide to Coaxial Adapter 6.5-18GHz WRD650 to N Type Male



650DRWECAS_Cu Endlaunch Double Ridge Waveguide to Coaxial Adapter 6.5-18GHz WRD650 to SMA Female



650DRWHCAN_Cu Right Angle High Power Double Ridge Waveguide to Coaxial Adapter 6.5-18GHz WRD650 to N Type Female



LB-65180-10-C-MB Round Type Mounting Bracket



LB-65180-10-C-MBL L type mounting bracket



Tripod_15Kg Al Alloy Tripod



3033HL Wooden Tripod



3033QM Wooden Tripod Metalfree



Carrying Case_LB-65180-10 Al Alloy Carrying Case

Similar Products

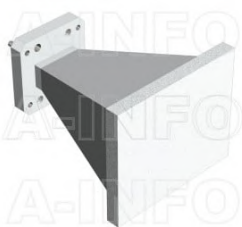

LB-60180-10-ASPO Multi Octave Horn Antenna 6.0-18.0GHz 10dB Gain Double Ridge Waveguide Interface



LB-60180-10-C-NF Multi Octave Horn Antenna 6.0-18.0GHz 10dB Gain N Type Female



LB-60180-10-C-NFSPO Multi Octave Horn Antenna 6.0-18.0GHz 10dB Gain N Type Female

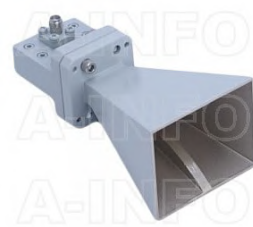

LB-60180-10-C-SF Multi Octave Horn Antenna 6.0-18.0GHz 10dB Gain SMA Female



LB-60180-10-C-SFSPO Multi Octave Horn Antenna 6.0-18GHz 10dB Gain SMA Female



LB-60180-10-C-HNF Multi Octave Horn Antenna 6.0-18.0GHz 10dB Gain High Power N Type Female



LB-60180-10-C-HNFSPO Multi Octave Horn Antenna 6.0-18.0GHz 10dB Gain High Power N Type Female

About this Datasheet

<ul style="list-style-type: none"> ● Product Information Product Link: https://www.ainfoinc.com/lb-60180-10-a-multi-octave-horn-antenna-6-0-18-0-ghz-10db-gain-fpwr650d28 Data subject to change without notice. © A-INFO INC. 2024. All Rights Reserved 	<ul style="list-style-type: none"> ● Contact Us Address: 60 Tesla, Irvine, CA 92618, USA Website: www.ainfoinc.com Email: sales@ainfoinc.com 	<ul style="list-style-type: none"> ● Phone & Fax Phone: +1-949-639-9688 +1-949-639-9608 Fax: +1-949-639-9670
---	--	--