



### LB-58160-20-ASPO Multi Octave Horn Antenna 5.8-16GHz 20dB Gain Double Ridge Waveguide Interface

Multi Octave Horn Antenna From 5.8GHz to 16GHz With a Nominal 20dB Gain With Double Ridge Waveguide Interface

## Product Information

SKU	LB-58160-20-ASPO
-----	------------------

## Description

Multi octave horn antenna LB-58160-20-ASPO, operating from 5.8 to 16GHz with a nominal 20dB gain and low VSWR 1.5:1 with FPWRD580D28 output. The model LB-58160-20-ASPO has uniform gain through its frequency span, providing efficient performance characteristics and directionality. Constructed of lightweight corrosion-resistant aluminum, the horn comes with a specially designed weatherproof radome which provides excellent protection against the rain and dust but has very little loss across the full operating frequency band. This multi octave horn antenna is linearly polarized and ideally suited for EMI testing, direction finding, surveillance, antenna gain and pattern measurements and other applications.

## Technical Specification

Electrical Specification		Interface	
Frequency, Min (GHz)	5.8	Output Type	Waveguide
Frequency, Max (GHz)	16	Flange Designation, WRD	FPWRD580D28
Waveguide Type	Double Ridge	Connector Gender	N/A
Waveguide Size EIA WRD	WRD580	Mechanical Specification	
Gain, Typ (dBi)	20	Figure	A Type
Polarization	Linear	Body Material	Al
3dB Beamwidth, E-Plane, Min (Deg.)	7	Finish	Chemical Conversion Coating, Gray Paint
3dB Beamwidth, E-Plane, Max (Deg.)	26	Size, W (mm)	134
3dB Beamwidth, H-Plane, Min (Deg.)	8	Size, H (mm)	111.9
3dB Beamwidth, H-Plane, Max (Deg.)	29	Size, L (mm)	246
Cross Pol. Isolation, Typ (dB)	40	Weight, (kg)	0.6
VSWR, Typ	1.5:1		

## Additional Information

Application	Outdoor, Waterproof and Dustproof, Fixed	Solution for	Gain Reference Antenna Measurement Far-field Measurement System Intergration
-------------	--	--------------	---

## Outline Drawing

FPWRD580D28 Output with Radome (Option, P/N: LB-58160-20-ASPO, Application Outdoor)

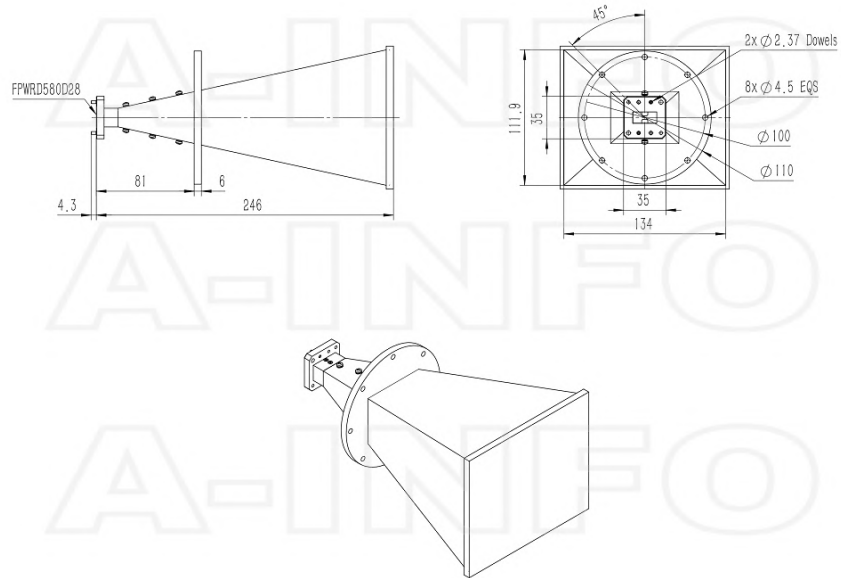

Flange Drawing

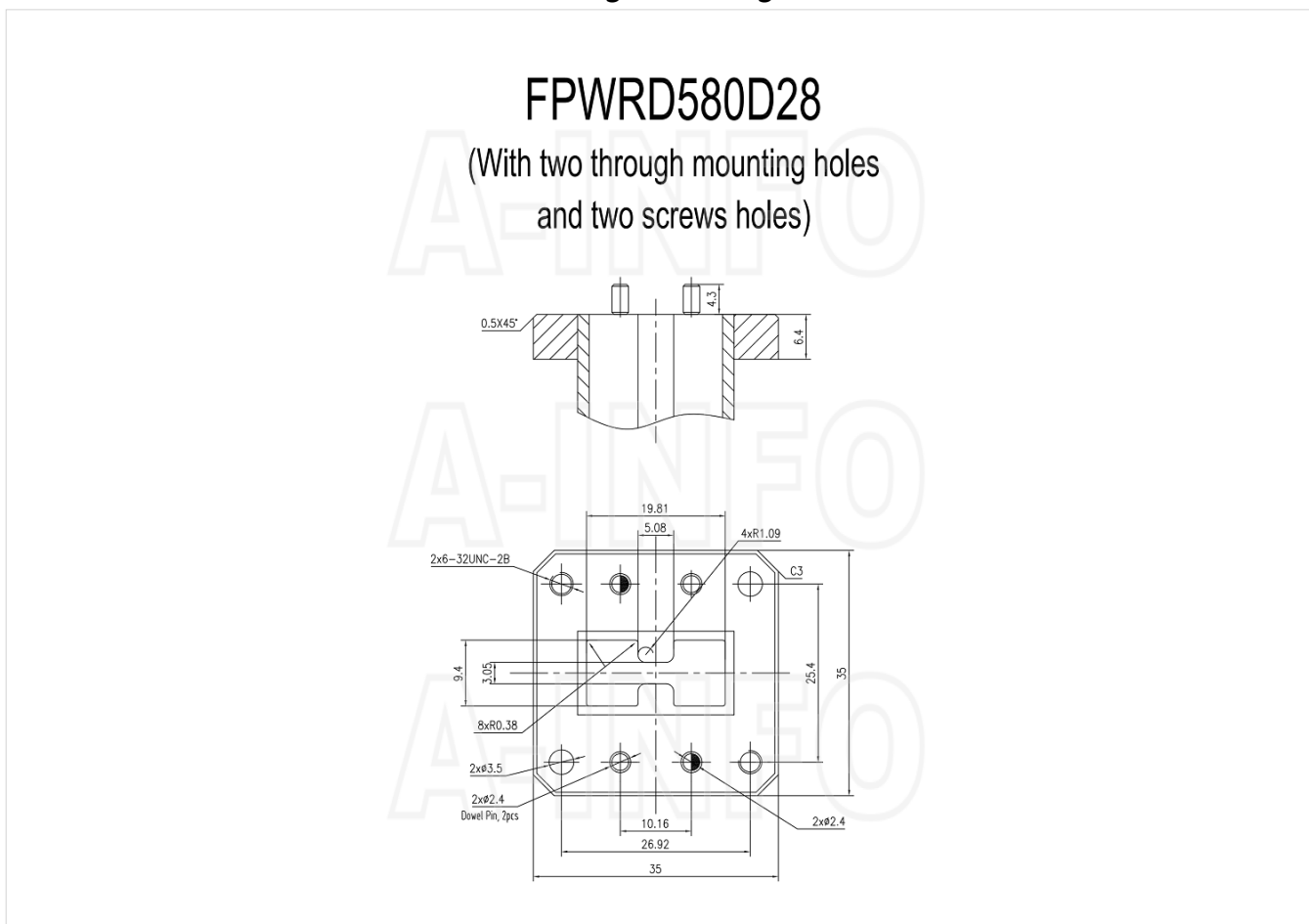

Typical Test Results

Gain

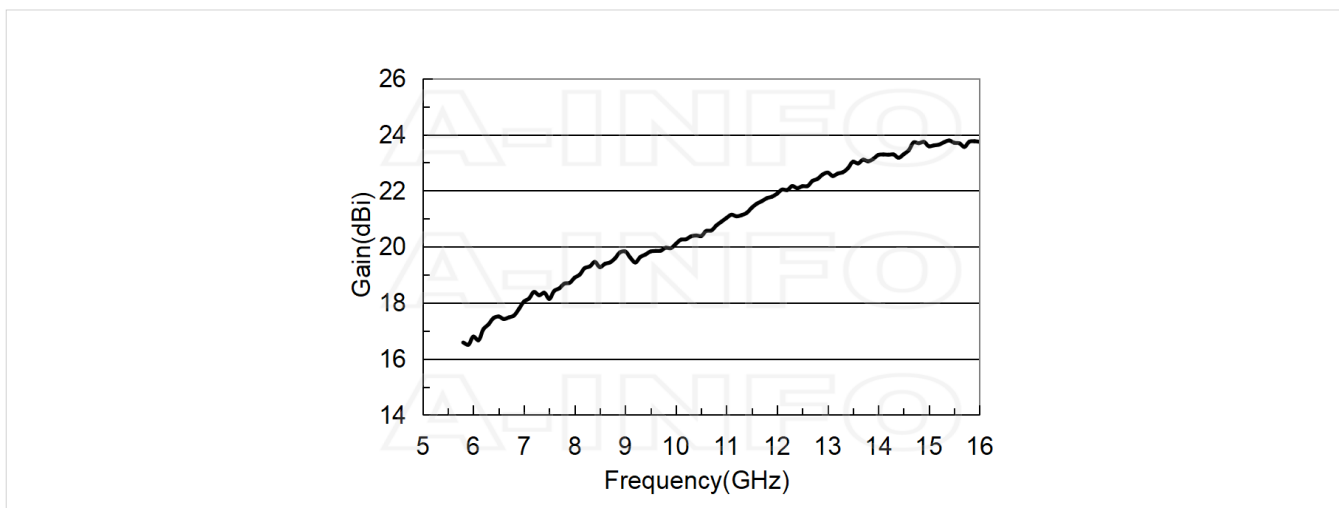

## Antenna Factor

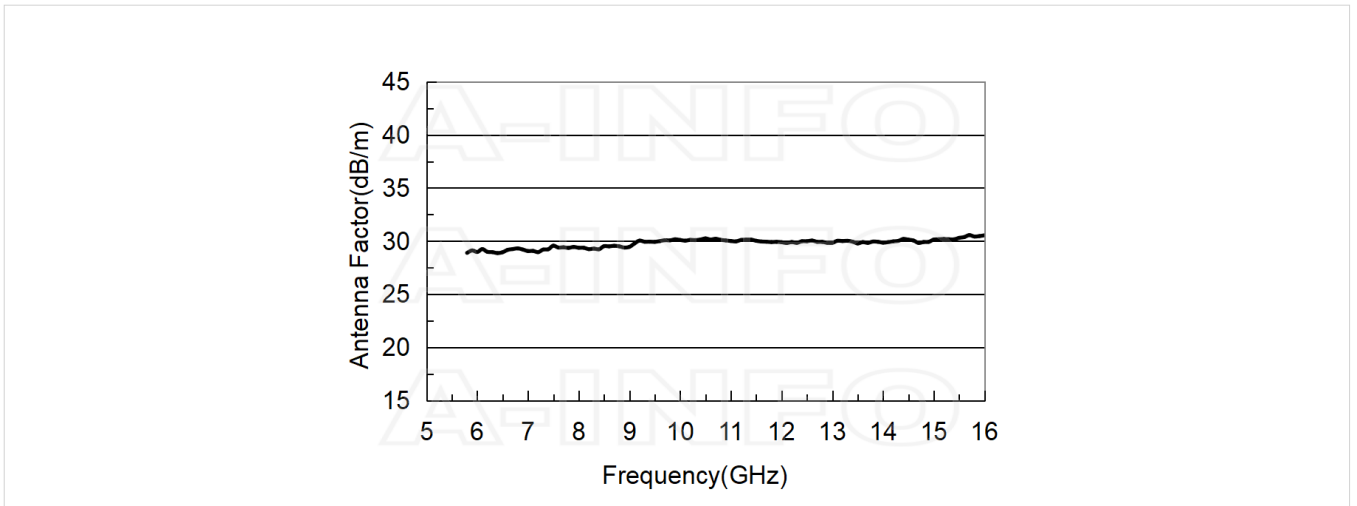

## Antenna Factor (Table)

Frequency(GHz)	Gain(dBi)	AF(dB/m)
5.8	16.58	28.90
6.0	16.79	28.98
7.0	18.04	29.07
8.0	18.89	29.38
9.0	19.83	29.46
10.0	20.10	30.11
11.0	21.02	30.01
12.0	21.89	29.90
13.0	22.64	29.85
14.0	23.27	29.86
15.0	23.58	30.15
16.0	23.74	30.55

## Cross Polarization Isolation

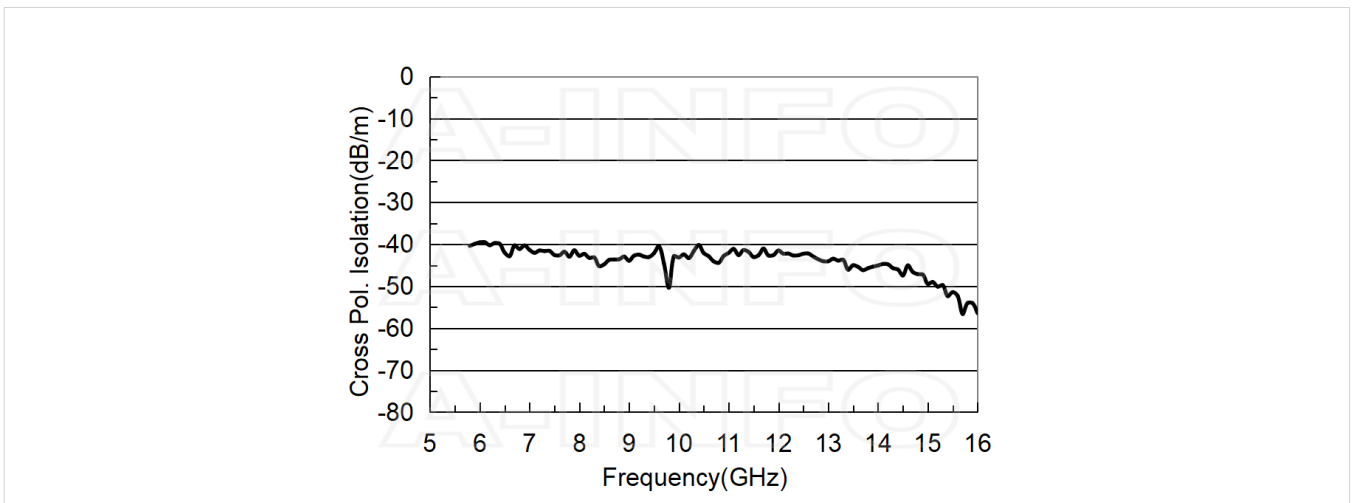

## VSWR

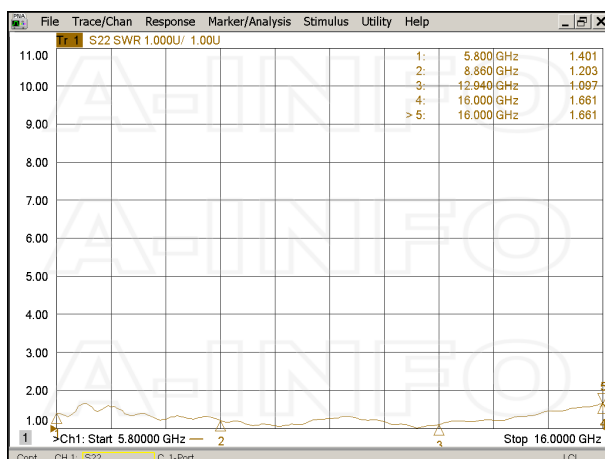

## Beamwidth

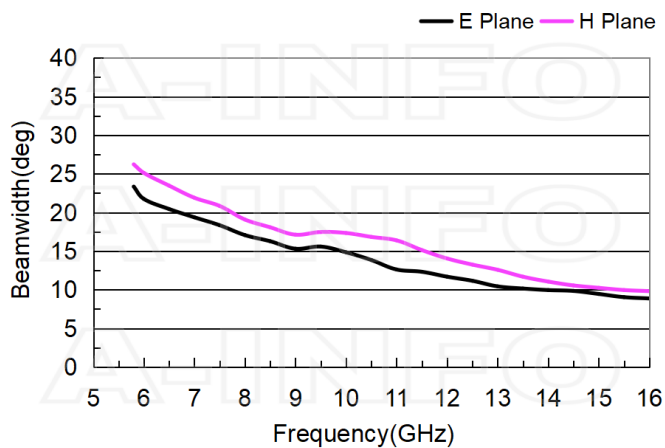

## Pattern

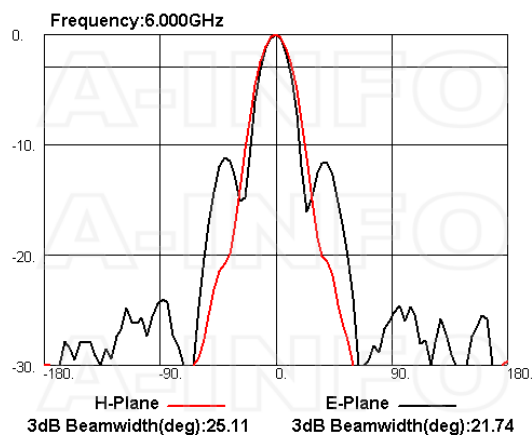
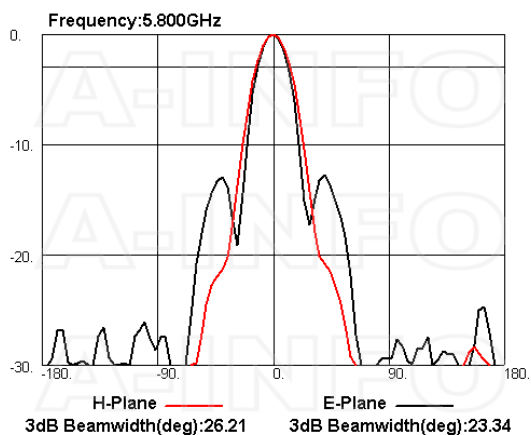

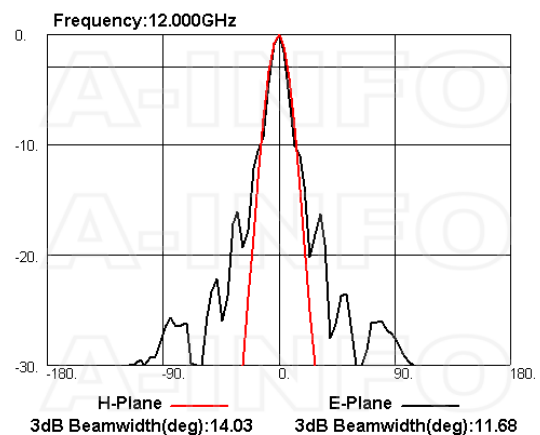
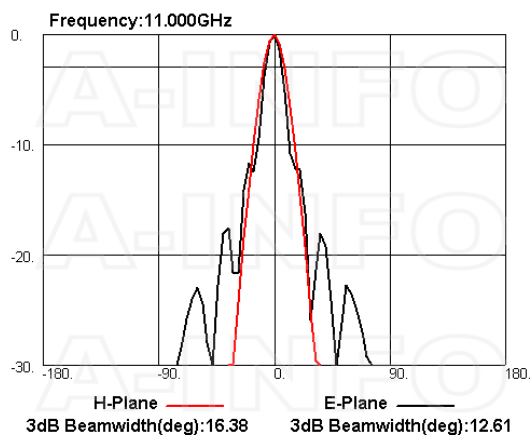
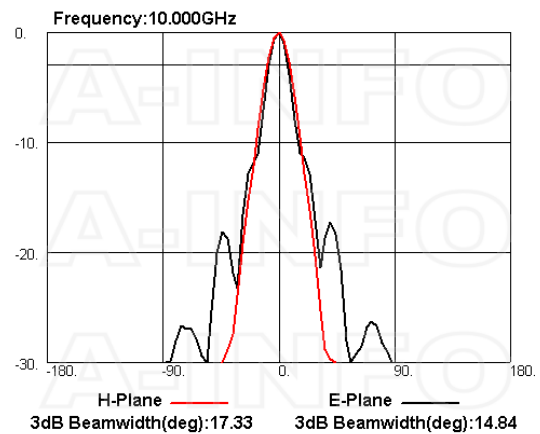
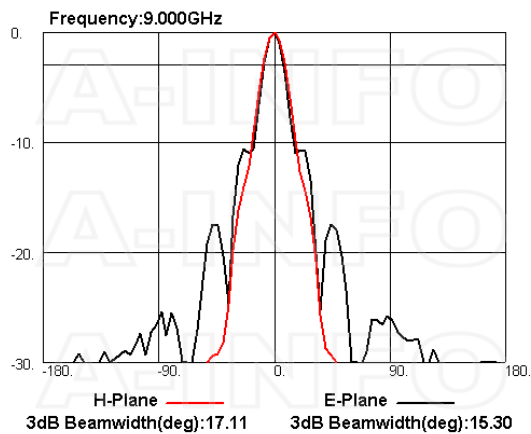
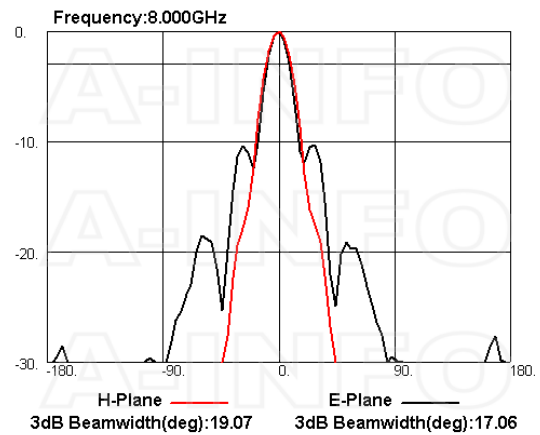
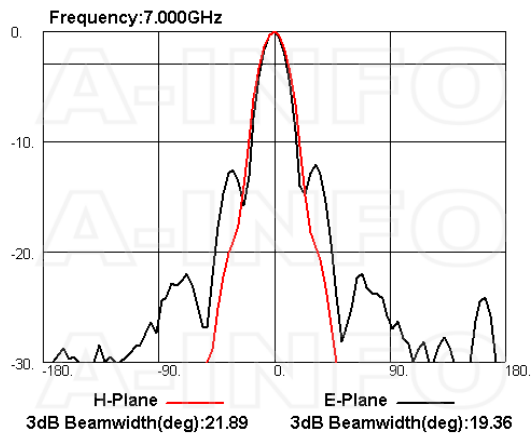

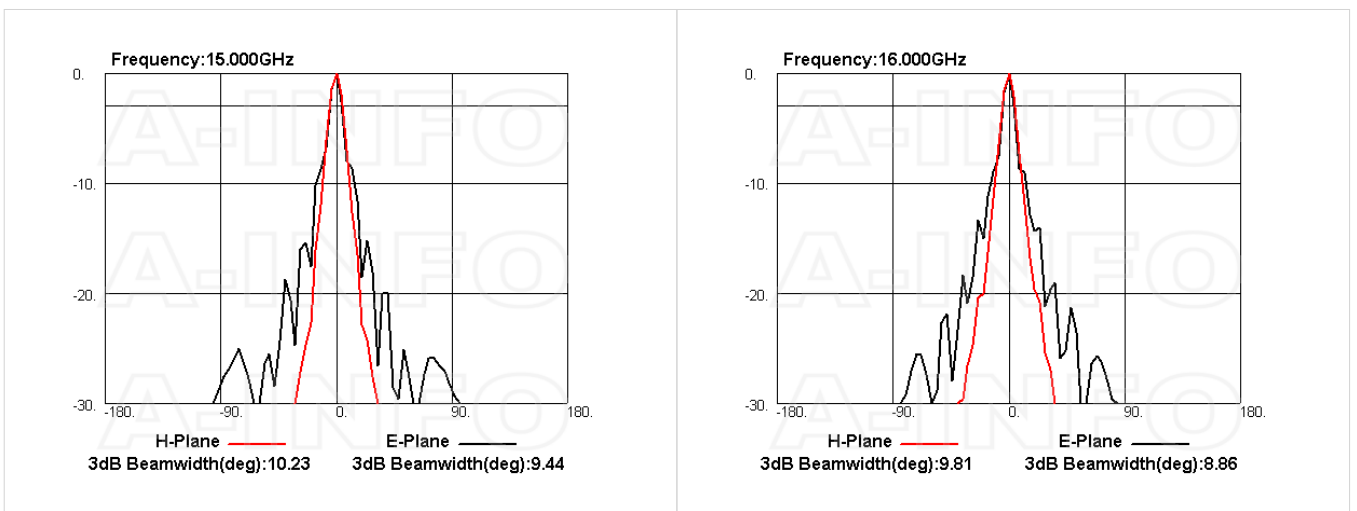
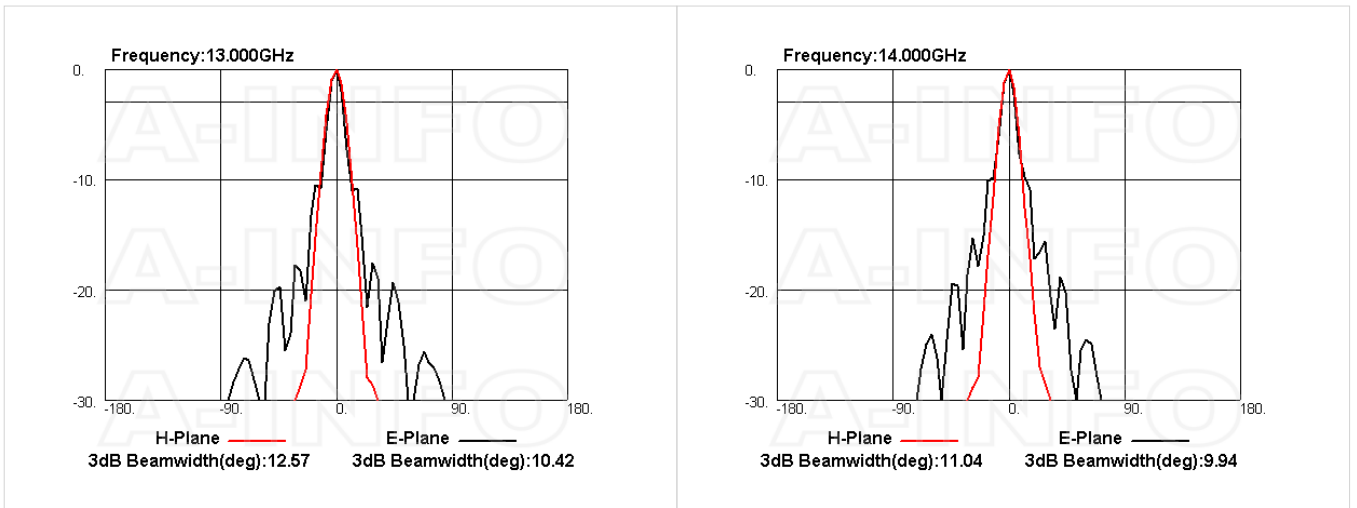

## Related Products



580DRWCAN\_Cu Right Angle Double Ridge Waveguide to Coaxial Adapter 5.8-16GHz WRD580 to N Type Female



580DRWCAS\_Cu Right Angle Double Ridge Waveguide to Coaxial Adapter 5.8-16GHz WRD580 to SMA Female



580DRWECAN\_Cu Endlaunch Double Ridge Waveguide to Coaxial Adapter 5.8-16GHz WRD580 to N Type Female



580DRWECAS\_Cu Endlaunch Double Ridge Waveguide to Coaxial Adapter 5.8-16GHz WRD580 to SMA Female



580DRWHCAN\_Cu Right Angle High Power Double Ridge Waveguide to Coaxial Adapter 5.8-16GHz WRD580 to N Type Female



LB-51-25-MB2 Round Type Mounting Bracket



LB-51-25-L2 L type mounting bracket



Tripod\_15Kg Al Alloy Tripod



3033HL Wooden Tripod



3033QM Wooden Tripod Metalfree

## Similar Products



LB-58160-20-A Multi Octave Horn Antenna 5.8-16GHz 20dB Gain Double Ridge Waveguide Interface



LB-58160-20-C-NF Multi Octave Horn Antenna 5.8-16GHz 20dB Gain N Type Female

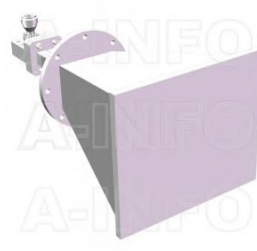

LB-58160-20-C-NFSPO Multi Octave Horn Antenna 5.8-16GHz 20dB Gain N Type Female



LB-58160-20-C-SF Multi Octave Horn Antenna 5.8-16GHz 20dB Gain SMA Female

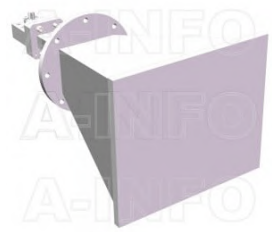

LB-58160-20-C-SFSPO Multi Octave Horn Antenna 5.8-16GHz 20dB Gain SMA Female

### About this Datasheet

<ul style="list-style-type: none"> <li>● <b>Product Information</b></li> </ul> <p>Product Link:  <a href="https://www.ainfoinc.com/lb-58160-20-aspo-multi-octave-horn-antenna-5-8-16-ghz-20db-gain-fpwr580d28">https://www.ainfoinc.com/lb-58160-20-aspo-multi-octave-horn-antenna-5-8-16-ghz-20db-gain-fpwr580d28</a>            Data subject to change without notice.            © A-INFO INC. 2024. All Rights Reserved</p>	<ul style="list-style-type: none"> <li>● <b>Contact Us</b></li> </ul> <p>Address:            60 Tesla, Irvine, CA 92618, USA</p> <p>Website:  <a href="http://www.ainfoinc.com">www.ainfoinc.com</a></p> <p>Email:  <a href="mailto:sales@ainfoinc.com">sales@ainfoinc.com</a></p>	<ul style="list-style-type: none"> <li>● <b>Phone &amp; Fax</b></li> </ul> <p>Phone:            +1-949-639-9688            +1-949-639-9608</p> <p>Fax:            +1-949-639-9670</p>
---	--	---