

LB-475110-15-C-NFSPO Multi Octave Horn Antenna 4.75-11GHz 15dB Gain N Type Female

Multi Octave Horn Antenna Operating From 4.75GHz to 11GHz With a Nominal 15dB Gain With N Type Female Connector

### Product Information

SKU	LB-475110-15-C-NFSPO
-----	----------------------

### Description

Multi octave horn antenna LB-475115-10-C-NFSPO, operating from 4.75 to 11GHz with a nominal 15dB gain and low VSWR 1.5:1 with N Type Female output connector. The model LB-475110-15-C-NFSPO has uniform gain through its frequency span, providing efficient performance characteristics and directionality. It can handle 150W continuously and 3000W peak power. Constructed of lightweight corrosion-resistant aluminum, the horn comes with a specially designed weatherproof radome which provides excellent protection against the rain and dust but has very little loss across the full operating frequency band. This multi octave horn antenna is linearly polarized and ideally suited for EMI testing, direction finding, surveillance, antenna gain and pattern measurements and other applications.

## Technical Specification

Electrical Specification		Interface	
Frequency, Min (GHz)	4.75	Output Type	Coaxial
Frequency, Max (GHz)	11	Connector	N Type
Waveguide Type	Double Ridge	Connector Gender	Female
Waveguide Size EIA WRD	WRD475	Mechanical Specification	
Gain, Typ (dBi)	15	Figure	C Type
Polarization	Linear	Body Material	Al
3dB Beamwidth, E-Plane, Min (Deg.)	18	Finish	Chemical Conversion Coating, Gray Paint
3dB Beamwidth, E-Plane, Max (Deg.)	39	Size, W (mm)	122
3dB Beamwidth, H-Plane, Min (Deg.)	17	Size, H (mm)	103
3dB Beamwidth, H-Plane, Max (Deg.)	45	Size, L (mm)	218.7
Cross Pol. Isolation, Typ (dB)	40	Weight, (kg)	0.5
VSWR, Typ	1.5:1		
Impedance, (Ohm)	50		
Power Handling, CW, (W)	150		
Power Handling, Peak, (W)	3000		

## Additional Information

Application	Outdoor, Waterproof and Dustproof, Fixed	Solution for	Gain Reference Antenna Measurement Far-field Measurement System Intergration
-------------	--	--------------	---

## Outline Drawing

N-Female Output with Radome (Option, P/N: LB-475110-15-C-NFSPO, Application Outdoor)

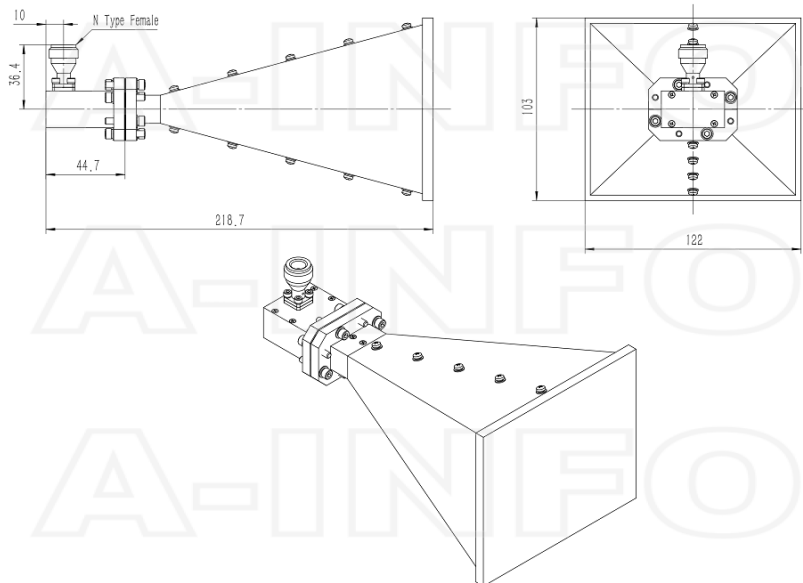

N-Female Output with Round Mounting Bracket & Radome (Option, P/N: LB-475110-10-C-MB & LB-475110-15-C-NFSPO, Application Outdoor)

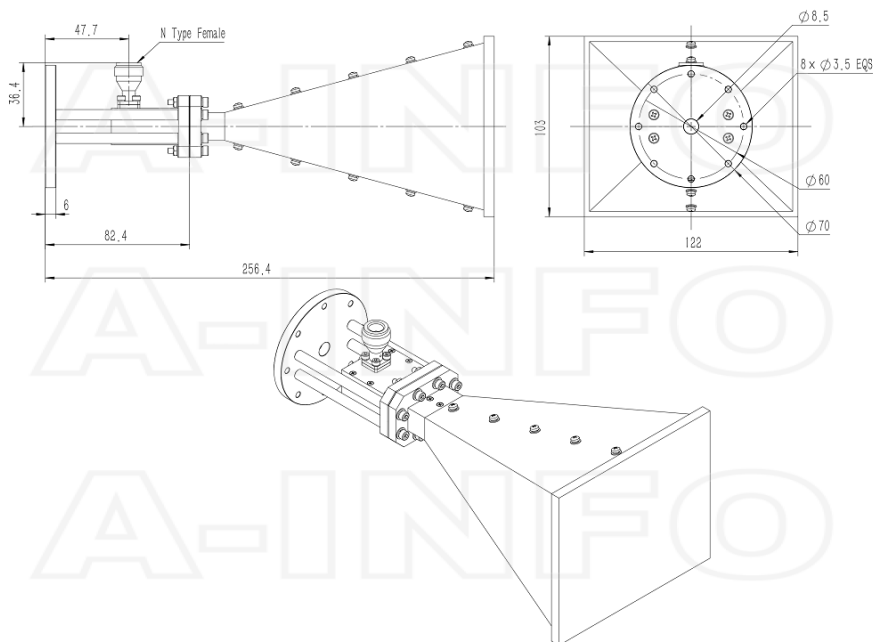

N-Female Output with L Type Mounting Bracket & Radome (Option, P/N: LB-475110-10-C-MBL & LB-475110-15-C-NFSPO, Application Outdoor)

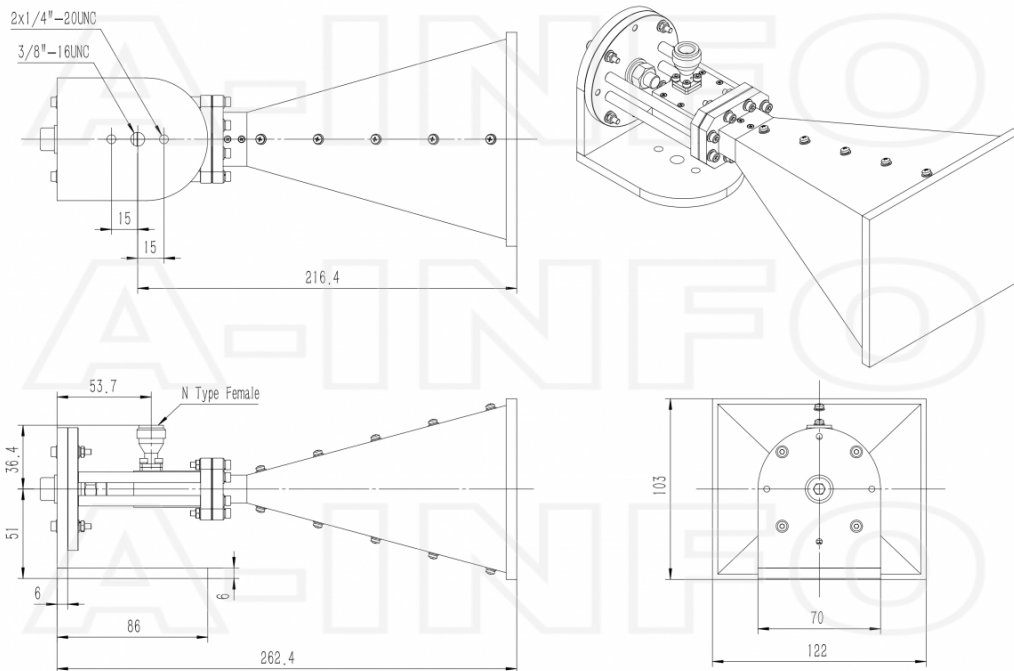

## Typical Test Results

### Gain

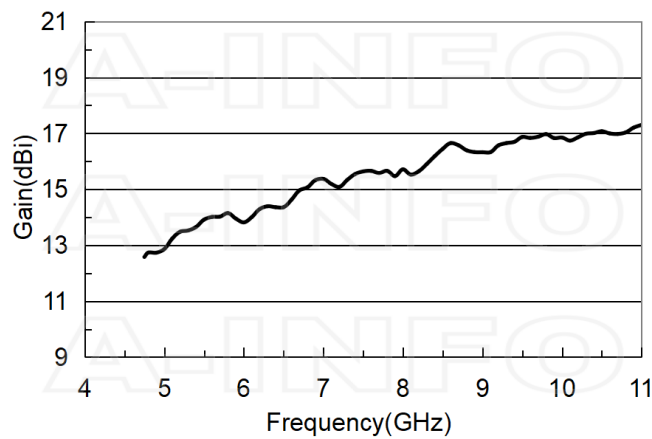

## Antenna Factor

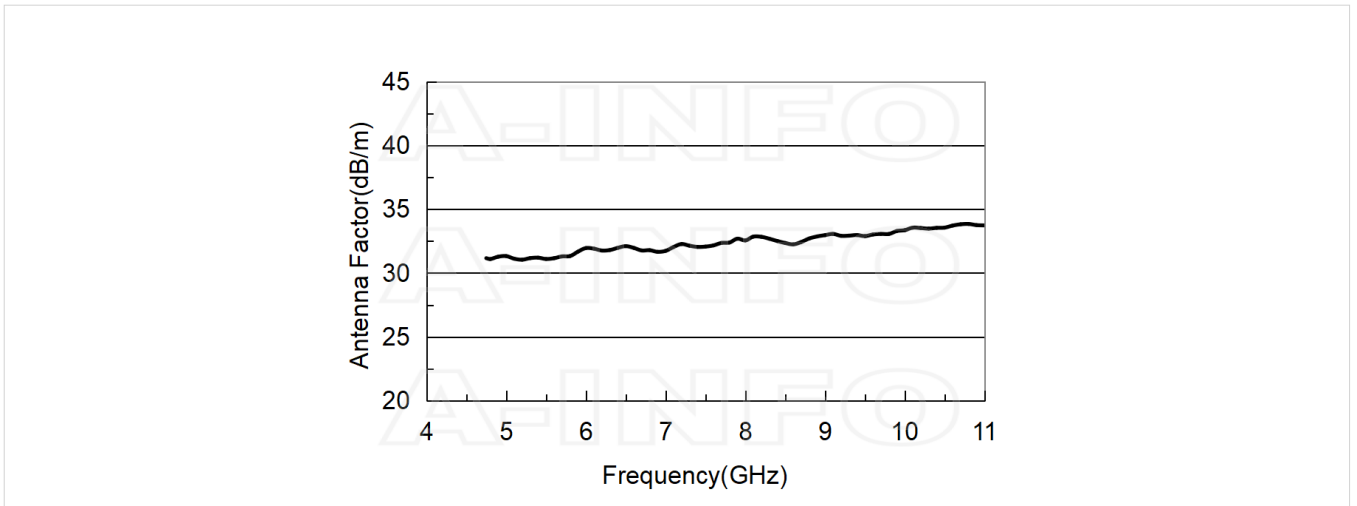

## Antenna Factor (Table)

Frequency(GHz)	Gain(dBi)	AF(dB/m)
4.75	12.58	31.16
5.0	12.86	31.33
5.5	13.91	31.10
6.0	13.82	31.96
6.5	14.36	32.11
7.0	15.37	31.74
7.5	15.64	32.07
8.0	15.71	32.56
8.5	16.44	32.35
9.0	16.32	32.97
9.5	16.87	32.89
10.0	16.85	33.36
10.5	17.07	33.56
11.0	17.30	33.73

## Cross Polarization Isolation

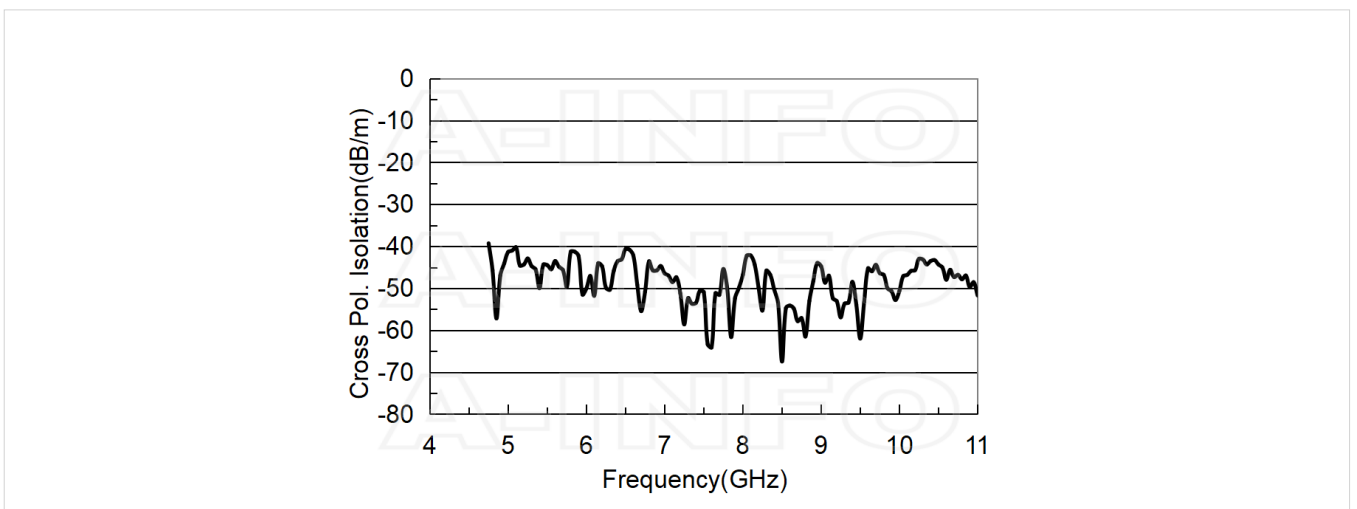

## VSWR

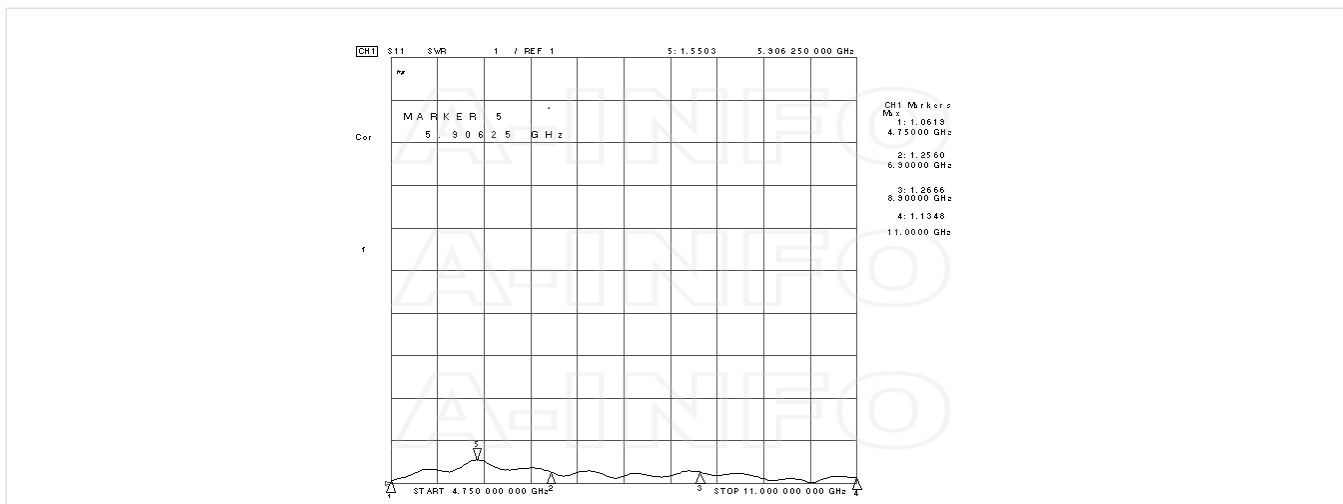

## Beamwidth

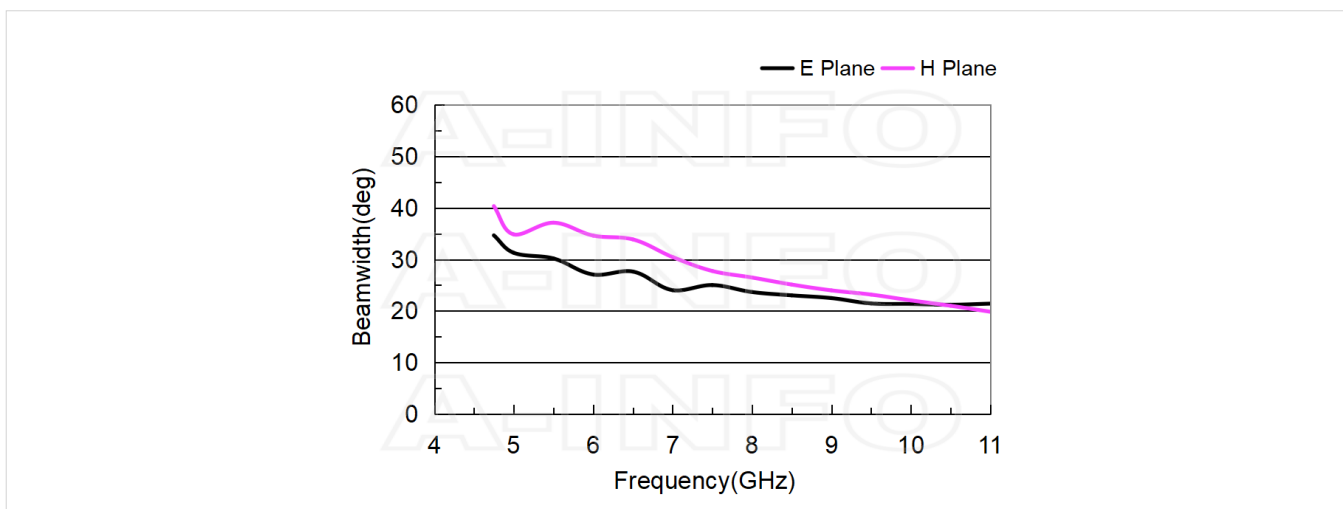

## Pattern

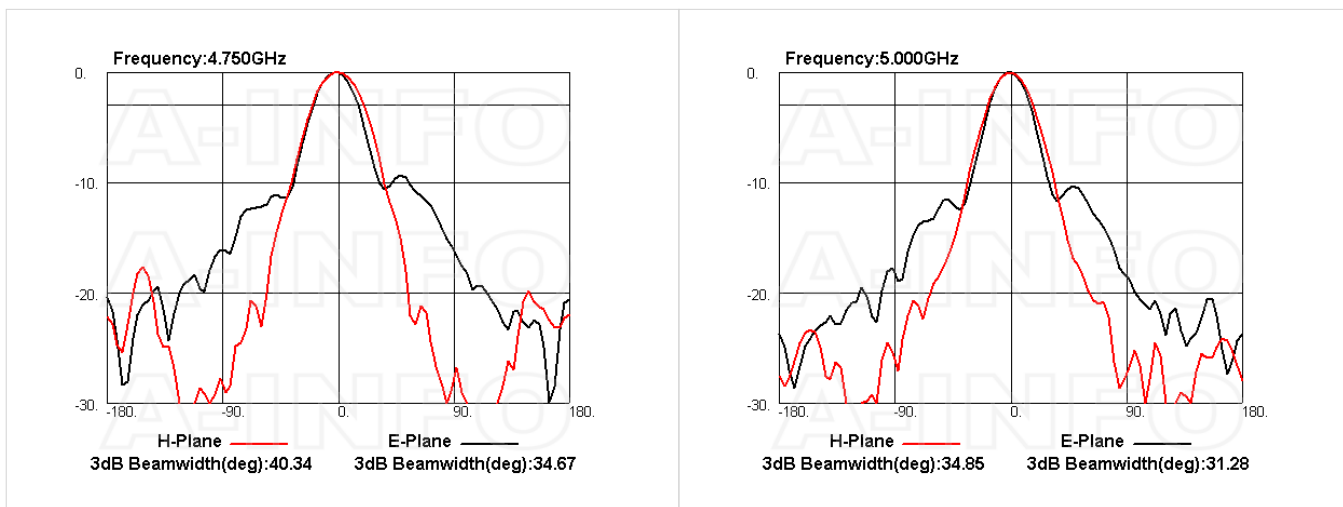

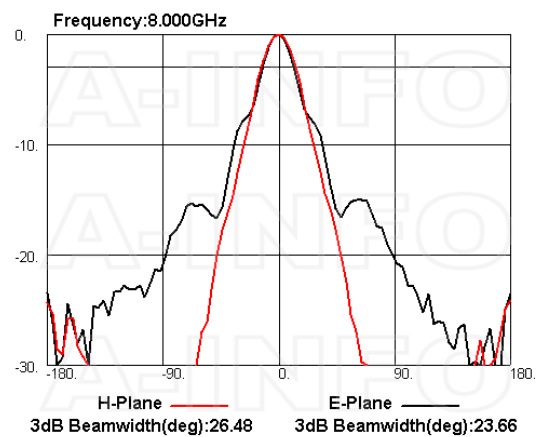
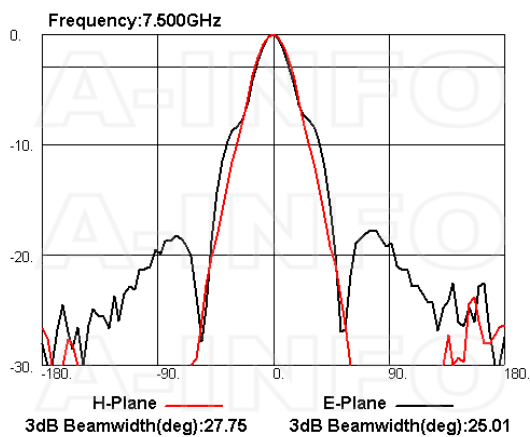
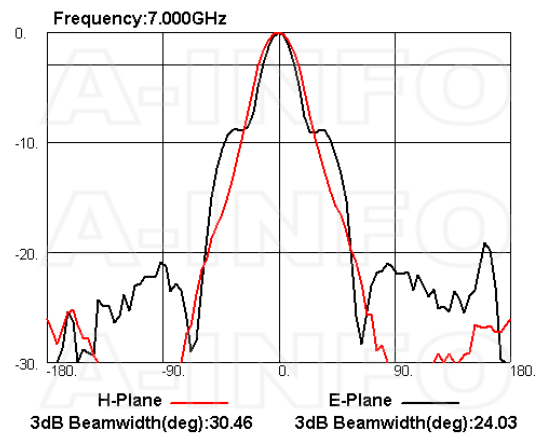
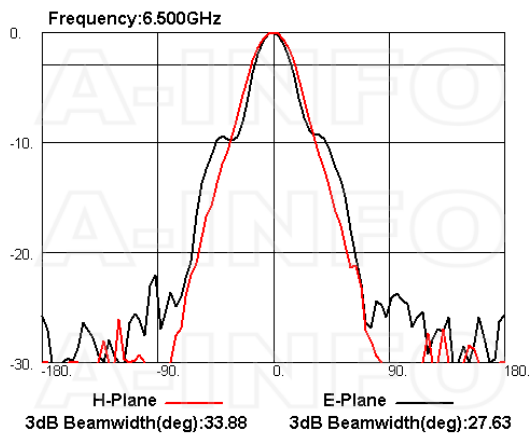
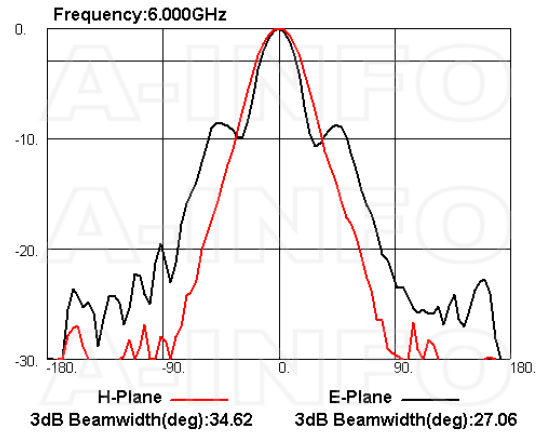
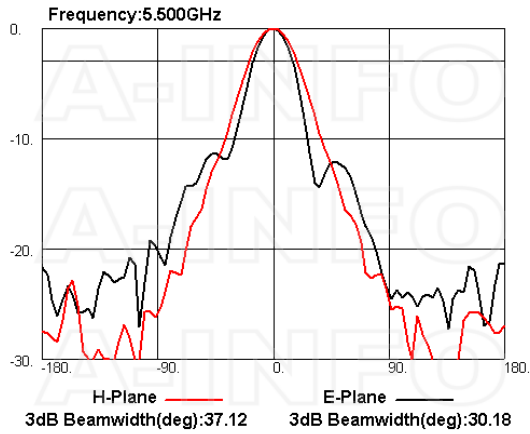

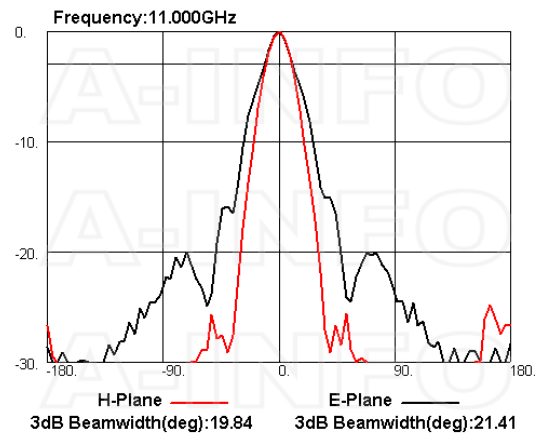
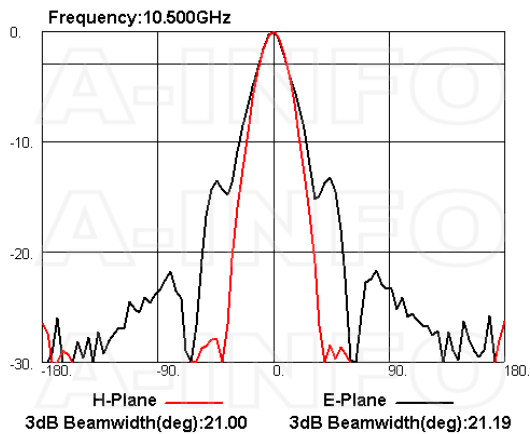
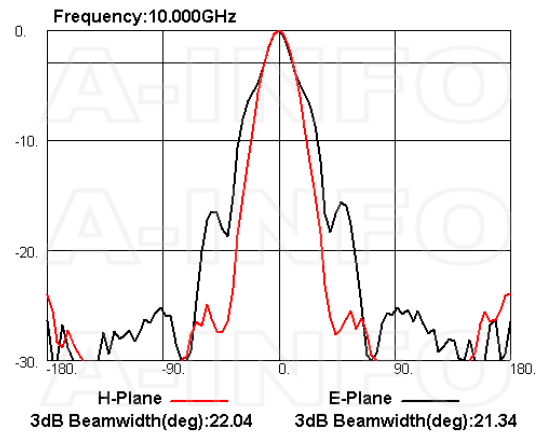
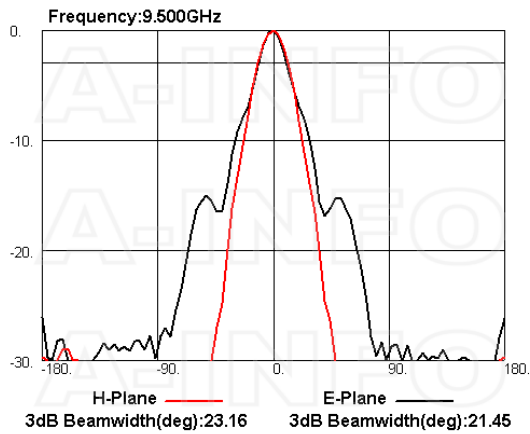
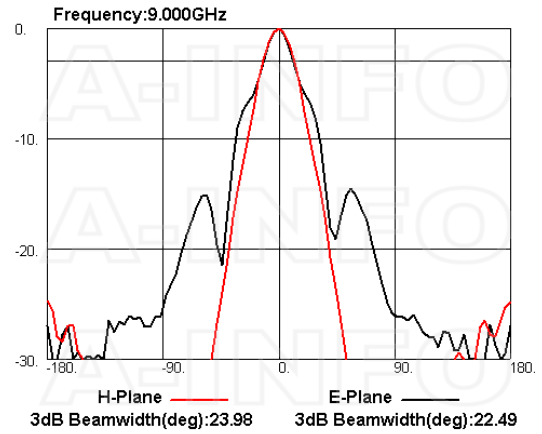
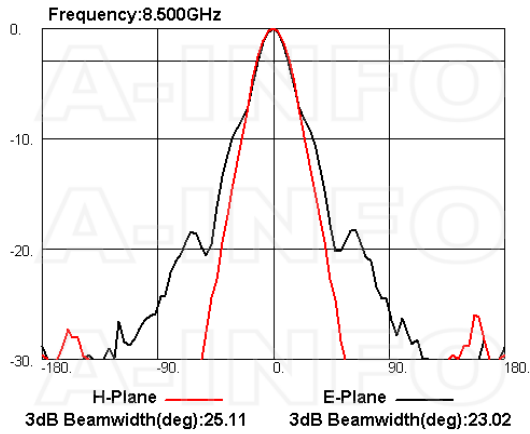

Related Products



LB-475110-10-C-MB Round Type Mounting Bracket



LB-475110-10-C-MBL L type mounting bracket



Tripod\_15Kg Al Alloy Tripod



3033HL Wooden Tripod



3033QM Wooden Tripod Metalfree



NM-NM-A050-1000 Flexible Cable Assembly 1000mm DC-18GHz N Male to N Male



NM-NM-A050-1500 Flexible Cable Assembly 1500mm DC-18GHz N Male to N Male



NM-NM-A050-2000 Flexible Cable Assembly 2000mm DC-18GHz N Male to N Male



NM-NM-A050-3000 Flexible Cable Assembly 3000mm DC-18GHz N Male to N Male



NM-NM-A050-5000 Flexible Cable Assembly 5000mm DC-18GHz N Male to N Male



NM-NM-A050-10000 Flexible Cable Assembly 10000mm DC-18GHz N Male to N Male



NM-NM-A050-20000 Flexible Cable Assembly 20000mm DC-18GHz N Male to N Male



NM-NM-A100-500 Flexible Cable Assembly 500mm DC-18GHz N Male to N Male



NM-NM-A100-1000 Flexible Cable Assembly 1000mm DC-18GHz N Male to N Male



NM-NM-A100-1500 Flexible Cable Assembly 1500mm DC-18GHz N Male to N Male



NM-NM-A100-2000 Flexible Cable Assembly 2000mm DC-18GHz N Male to N Male



NM-NM-A100-3000 Flexible Cable Assembly 3000mm DC-18GHz N Male to N Male



NM-NM-A100-5000 Flexible Cable Assembly 5000mm DC-18GHz N Male to N Male



NM-NM-A100-10000 Flexible Cable Assembly 10000mm DC-18GHz N Male to N Male



NM-NM-A100-20000 Flexible Cable Assembly 20000mm DC-18GHz N Male to N Male

### Similar Products

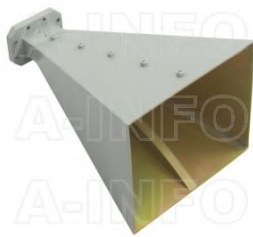

LB-475110-15-A Multi Octave Horn Antenna 4.75-11GHz 15dB Gain Double Ridge Waveguide Interface

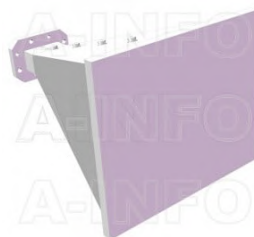

LB-475110-15-ASPO Multi Octave Horn Antenna 4.75-11GHz 15dB Gain Double Ridge Waveguide Interface



LB-475110-15-C-NF Multi Octave Horn Antenna 4.75-11GHz 15dB Gain N Type Female

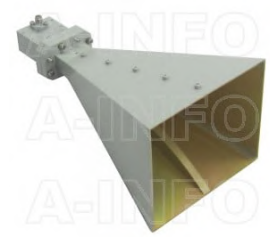

LB-475110-15-C-SF Multi Octave Horn Antenna 4.75-11GHz 15dB Gain SMA Female

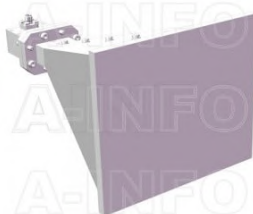

LB-475110-15-C-SFSP0 Multi Octave Horn Antenna 4.75-11GHz 15dB Gain SMA Female

### About this Datasheet

<ul style="list-style-type: none"> <li>● <b>Product Information</b> Product Link: <a href="https://www.ainfoinc.com/lb-475110-15-c-nfsp0-multi-octave-horn-antenna-4-75-11-ghz-15db-gain-n-type-female">https://www.ainfoinc.com/lb-475110-15-c-nfsp0-multi-octave-horn-antenna-4-75-11-ghz-15db-gain-n-type-female</a> Data subject to change without notice. © A-INFO INC. 2024. All Rights Reserved</li> </ul>	<ul style="list-style-type: none"> <li>● <b>Contact Us</b> Address: 60 Tesla, Irvine, CA 92618, USA  Website: <a href="http://www.ainfoinc.com">www.ainfoinc.com</a>  Email: <a href="mailto:sales@ainfoinc.com">sales@ainfoinc.com</a></li> </ul>	<ul style="list-style-type: none"> <li>● <b>Phone &amp; Fax</b> Phone: +1-949-639-9688 +1-949-639-9608  Fax: +1-949-639-9670</li> </ul>
---	--	---