

LB-475110-15-ASPO Multi Octave Horn Antenna 4.75-11GHz 15dB Gain Double Ridge Waveguide Interface

Multi Octave Horn Antenna From 4.75GHz to 11GHz With a Nominal 15dB Gain With Double Ridge Waveguide Interface

### Product Information

SKU	LB-475110-15-ASPO
-----	-------------------

### Description

Multi octave horn antenna LB-475110-15-ASPO, operating from 4.75 to 11GHz with a nominal 15dB gain and low VSWR 1.5:1 with FPWRD475D24 output. The model LB-475110-15-ASPO has uniform gain through its frequency span, providing efficient performance characteristics and directionality. Constructed of lightweight corrosion-resistant aluminum, the horn comes with a specially designed weatherproof radome which provides excellent protection against the rain and dust but has very little loss across the full operating frequency band. This multi octave horn antenna is linearly polarized and ideally suited for EMI testing, direction finding, surveillance, antenna gain and pattern measurements and other applications.

### Technical Specification

Electrical Specification		Interface	
Frequency, Min (GHz)	4.75	Output Type	Waveguide
Frequency, Max (GHz)	11	Flange Designation, WRD	FPWRD475D24
Waveguide Type	Double Ridge	Connector Gender	N/A
Waveguide Size EIA WRD	WRD475	Mechanical Specification	
Gain, Typ (dBi)	15	Figure	A Type
Polarization	Linear	Body Material	Al
3dB Beamwidth, E-Plane, Min (Deg.)	18	Finish	Chemical Conversion Coating, Gray Paint
3dB Beamwidth, E-Plane, Max (Deg.)	39	Size, W (mm)	122
3dB Beamwidth, H-Plane, Min (Deg.)	17	Size, H (mm)	103
3dB Beamwidth, H-Plane, Max (Deg.)	45	Size, L (mm)	174
Cross Pol. Isolation, Typ (dB)	40	Weight, (kg)	0.3
VSWR, Typ	1.5:1		

## Additional Information

Application	Outdoor, Waterproof and Dustproof, Fixed	Solution for	Gain Reference Antenna Measurement Far-field Measurement System Intergration
-------------	--	--------------	---

## Outline Drawing

FPWRD475D24 Output with Radome (Option, P/N: LB-475110-15-ASPO, Application Outdoor)

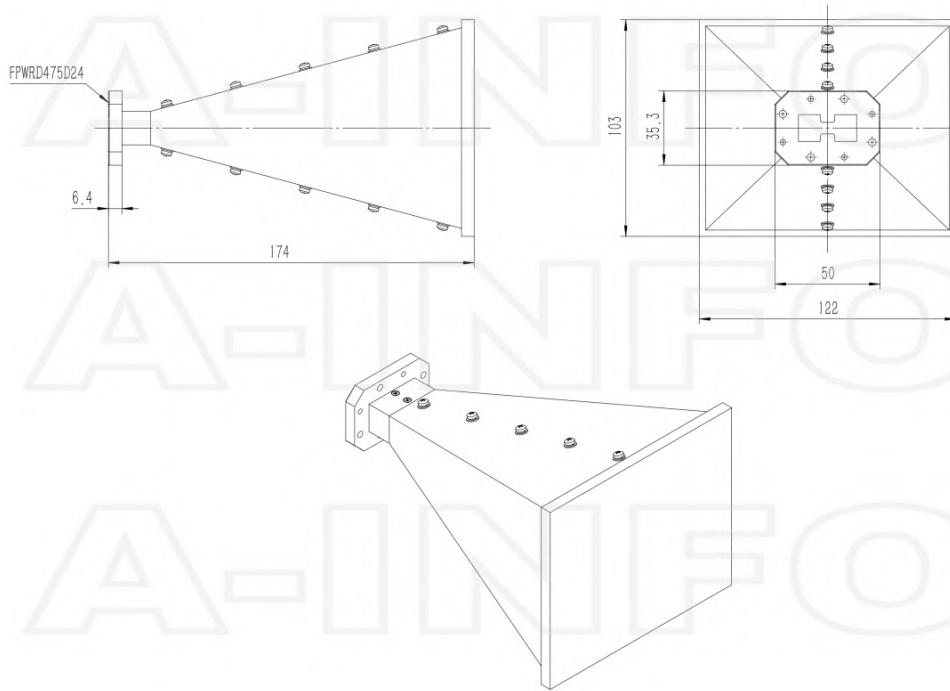

Flange Drawing

FPWRD475D24

(With four through mounting holes and four screws holes)

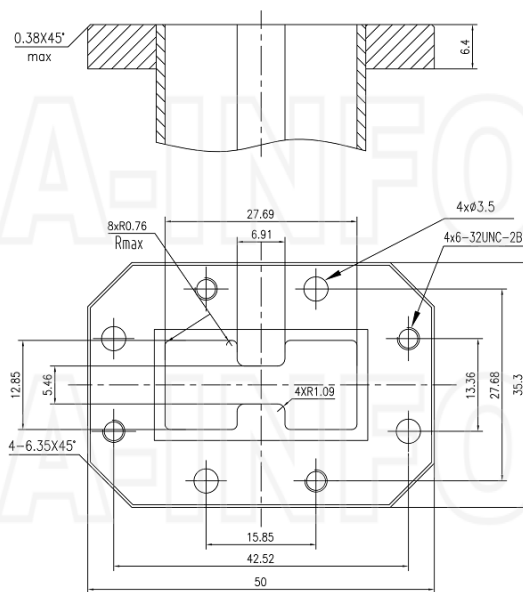

Typical Test Results

Gain

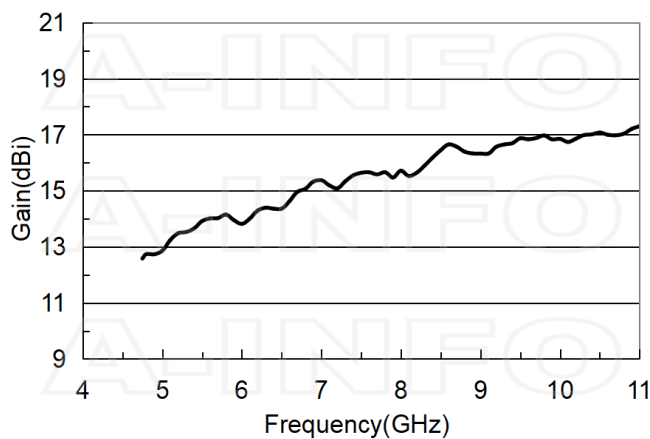

## Antenna Factor

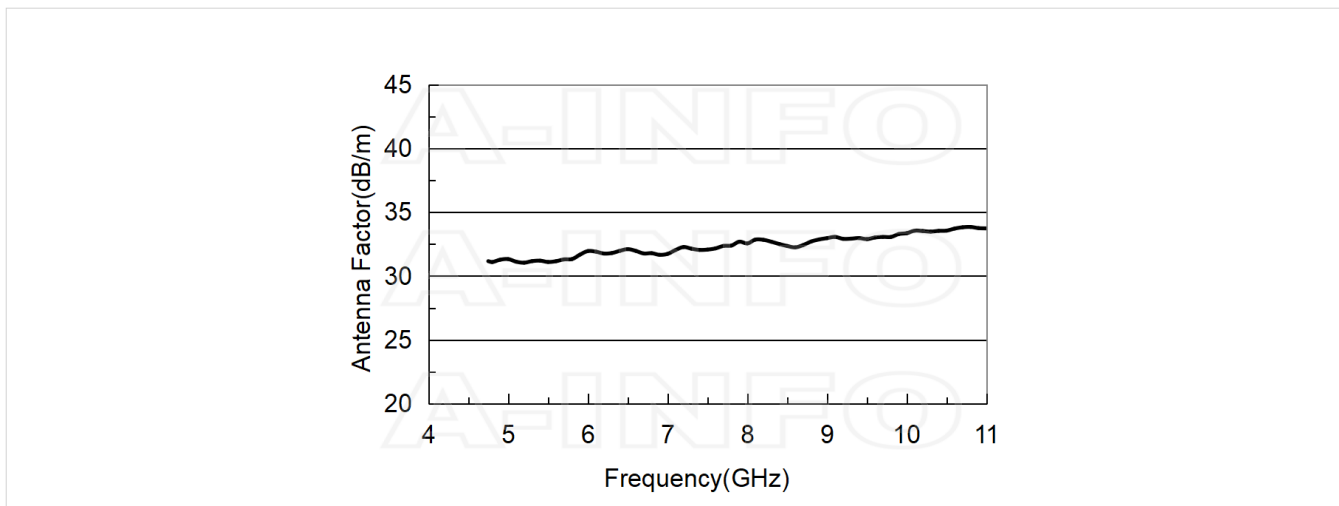

## Antenna Factor (Table)

Frequency(GHz)	Gain(dBi)	AF(dB/m)
4.75	12.58	31.16
5.0	12.86	31.33
5.5	13.91	31.10
6.0	13.82	31.96
6.5	14.36	32.11
7.0	15.37	31.74
7.5	15.64	32.07
8.0	15.71	32.56
8.5	16.44	32.35
9.0	16.32	32.97
9.5	16.87	32.89
10.0	16.85	33.36
10.5	17.07	33.56
11.0	17.30	33.73

## Cross Polarization Isolation

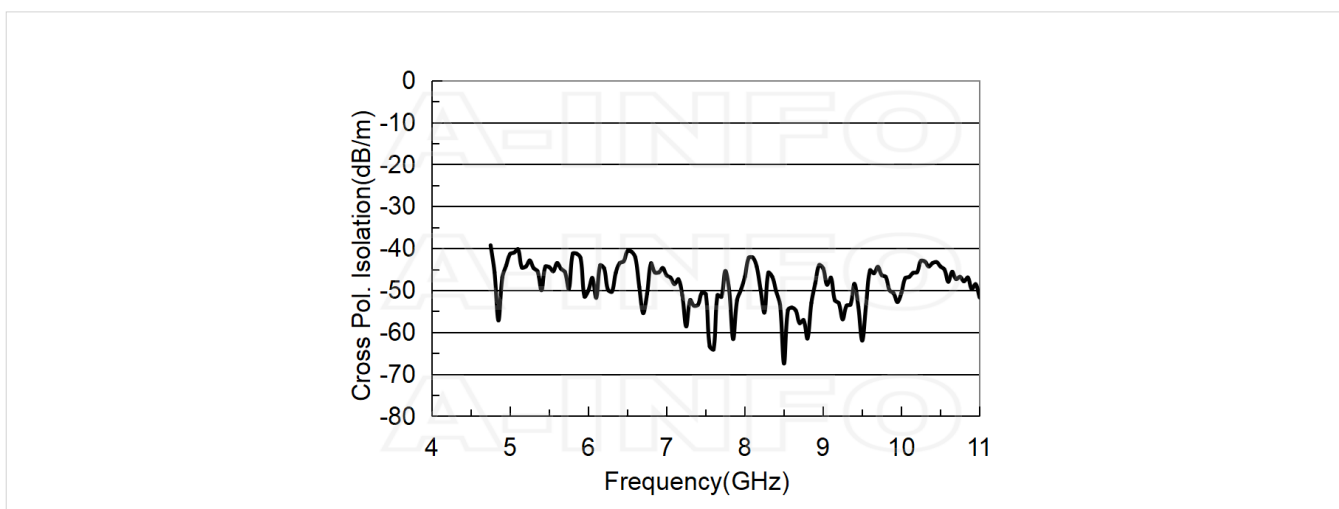

## VSWR

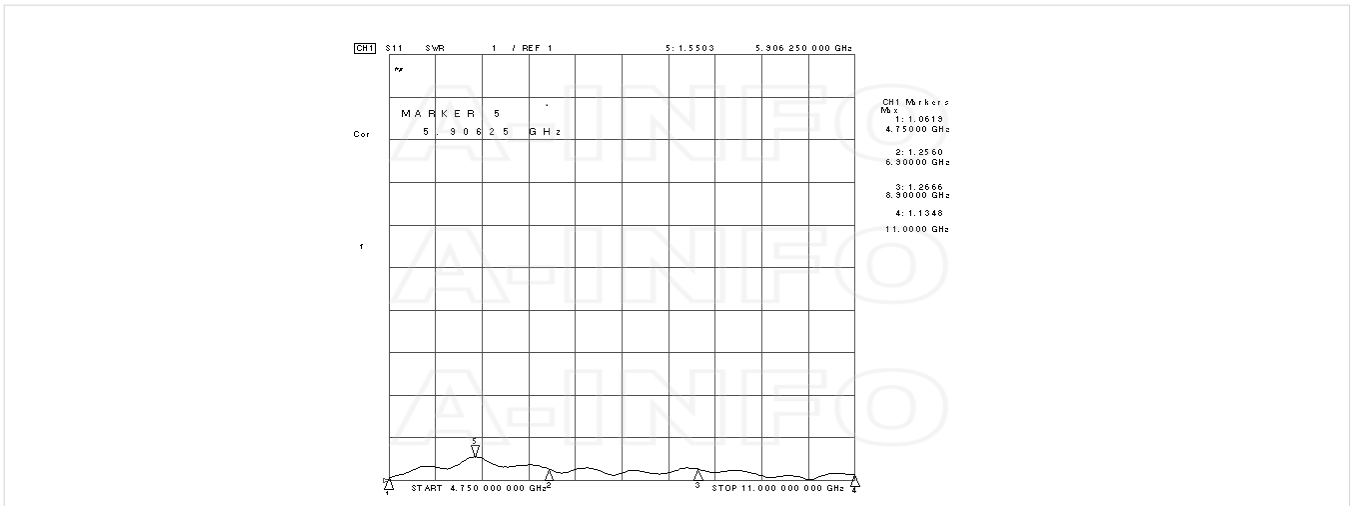

## Beamwidth

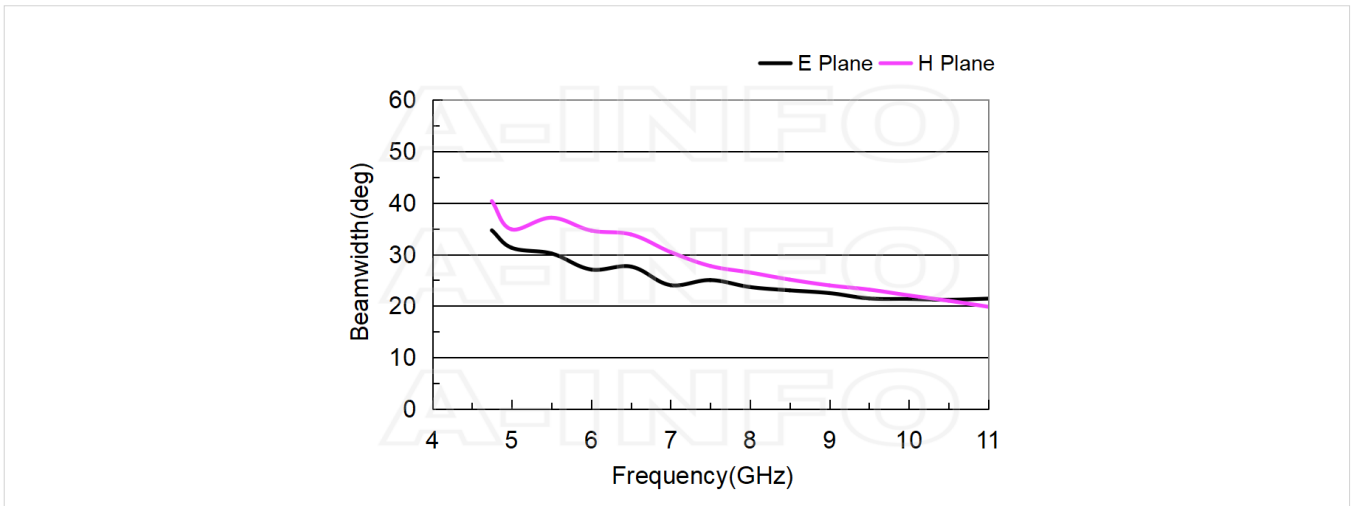

## Pattern

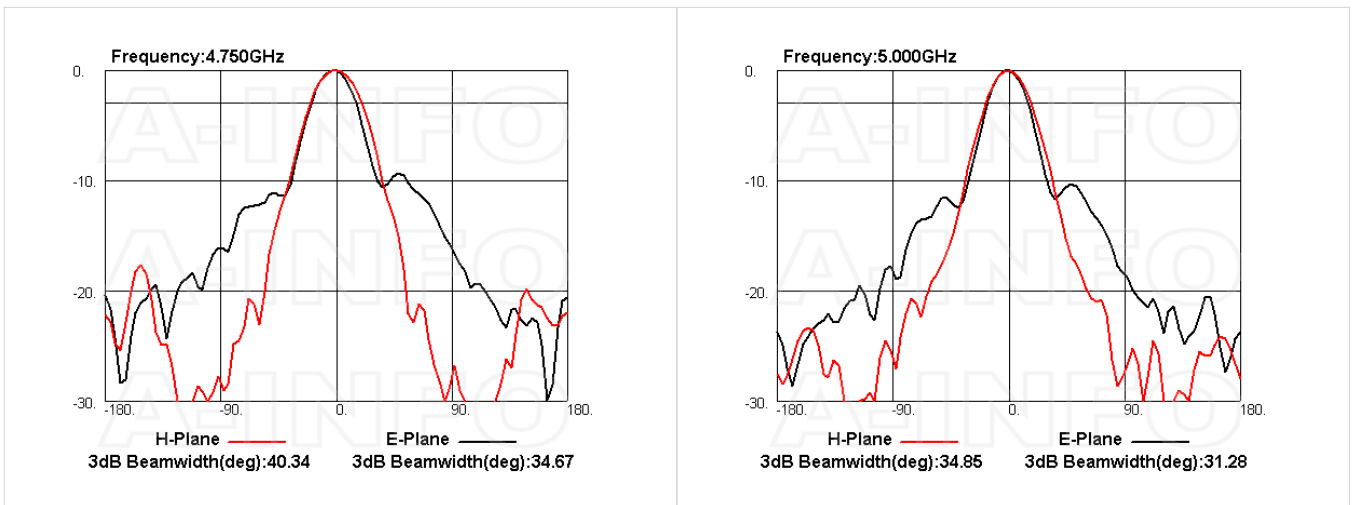

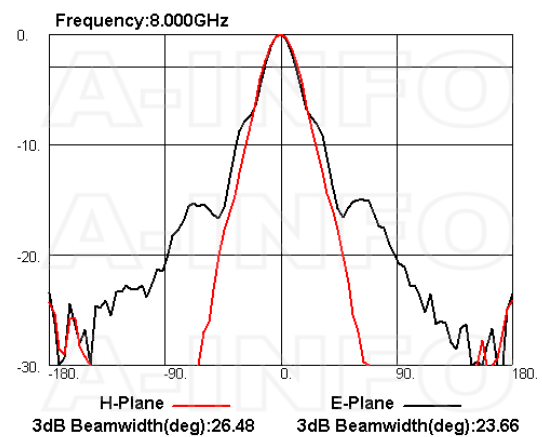
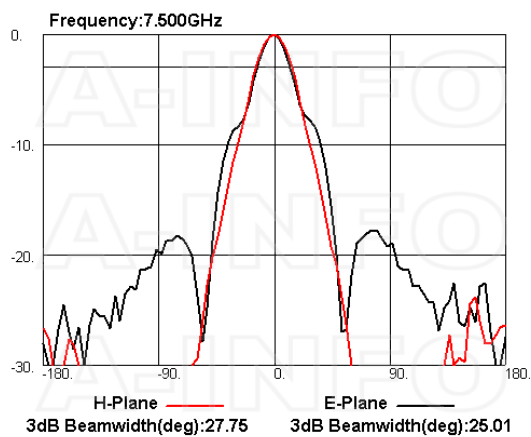
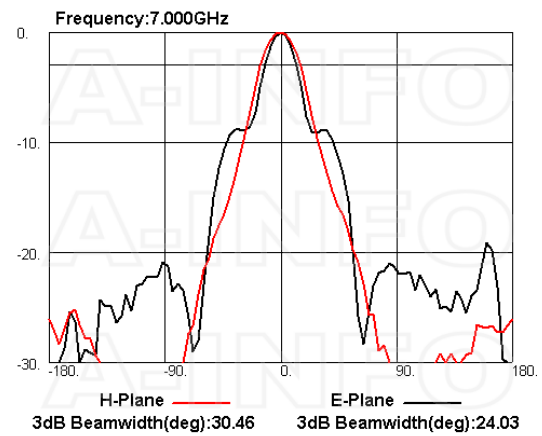
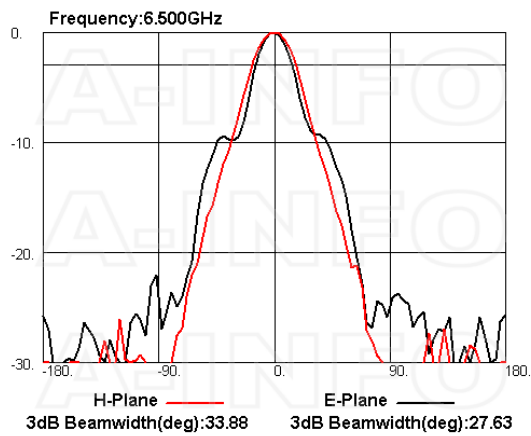
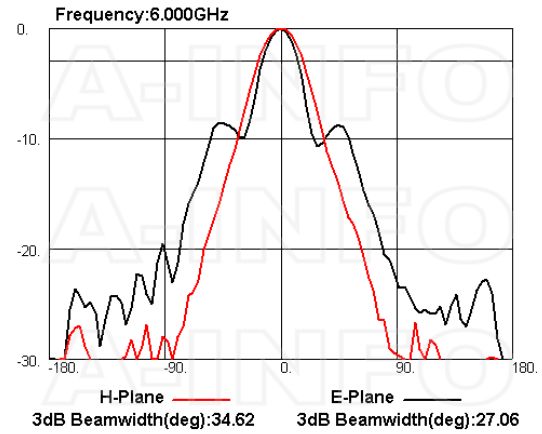
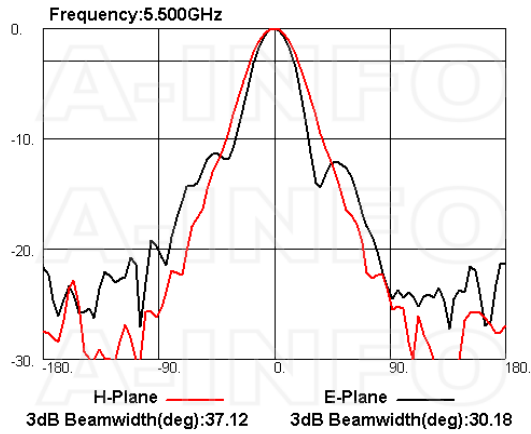

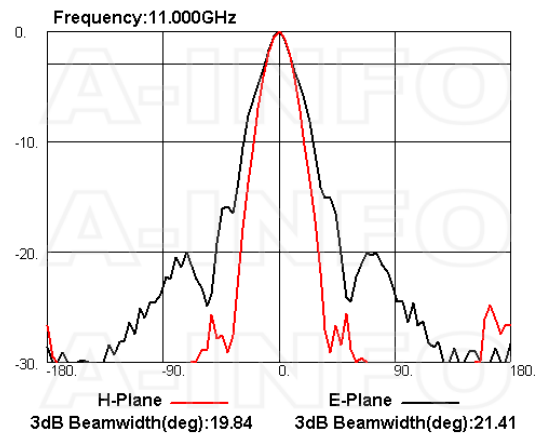
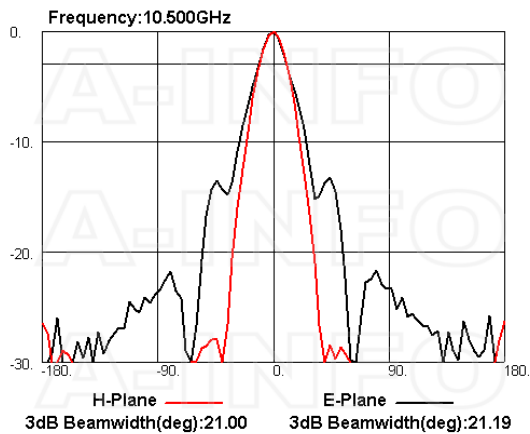
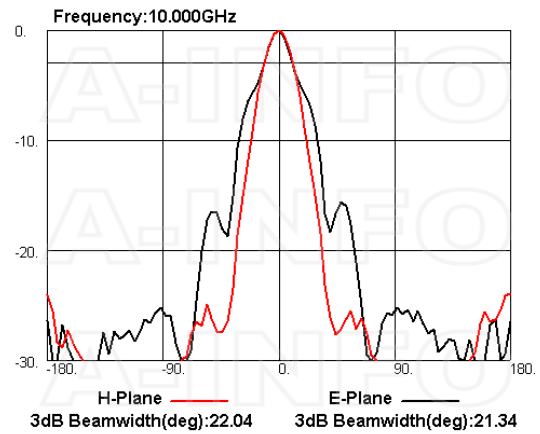
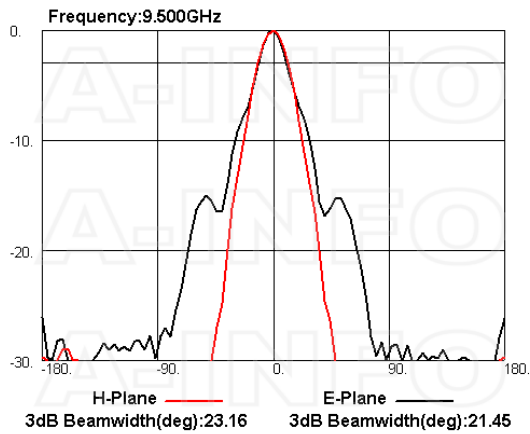
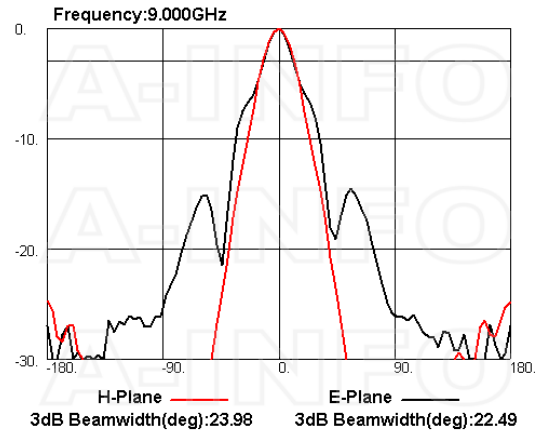
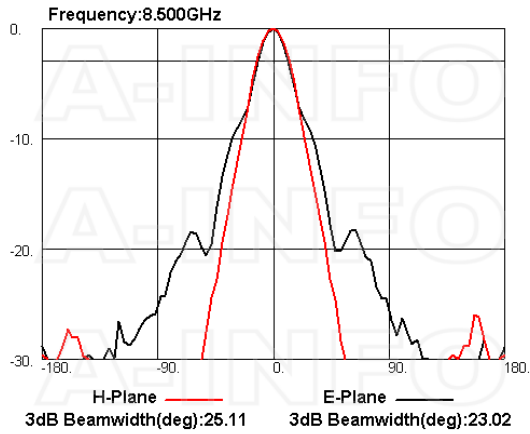

## Related Products



475DRWCAN Right Angle Double Ridge Waveguide to Coaxial Adapter 4.75-11GHz WRD475 to N Type Female



475DRWCAS Right Angle Double Ridge Waveguide to Coaxial Adapter 4.75-11GHz WRD475 to SMA Female



475DRWECAN Endlaunch Double Ridge Waveguide to Coaxial Adapter 4.75-11GHz WRD475 to N Type Female



475DRWECAS Endlaunch Double Ridge Waveguide to Coaxial Adapter 4.75-11GHz WRD475 to SMA Female



475DRWHCAN Right Angle High Power Double Ridge Waveguide to Coaxial Adapter 4.75-11GHz WRD475 to N Type Female



LB-475110-10-C-MB Round Type Mounting Bracket



LB-475110-10-C-MBL L type mounting bracket



Tripod\_15Kg Al Alloy Tripod



3033HL Wooden Tripod



3033QM Wooden Tripod Metalfree

## Similar Products

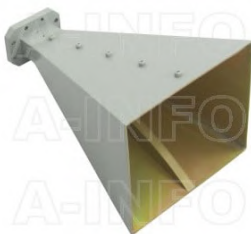

LB-475110-15-A Multi Octave Horn Antenna 4.75-11GHz 15dB Gain Double Ridge Waveguide Interface



LB-475110-15-C-NF Multi Octave Horn Antenna 4.75-11GHz 15dB Gain N Type Female

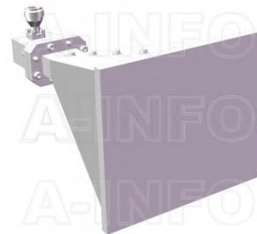

LB-475110-15-C-NFSPO Multi Octave Horn Antenna 4.75-11GHz 15dB Gain N Type Female



LB-475110-15-C-SF Multi Octave Horn Antenna 4.75-11GHz 15dB Gain SMA Female

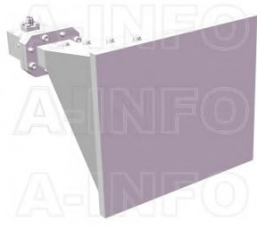

LB-475110-15-C-SFSP0 Multi Octave Horn Antenna  
4.75-11GHz 15dB Gain SMA Female

## About this Datasheet

<ul style="list-style-type: none"> <li>• <b>Product Information</b> Product Link: <a href="https://www.ainfoinc.com/lb-475110-15-aspo-multi-octave-horn-antenna-4-75-11-ghz-15db-gain-fpwr475d24">https://www.ainfoinc.com/lb-475110-15-aspo-multi-octave-horn-antenna-4-75-11-ghz-15db-gain-fpwr475d24</a> Data subject to change without notice. © A-INFO INC. 2024. All Rights Reserved</li> </ul>	<ul style="list-style-type: none"> <li>• <b>Contact Us</b> Address: 60 Tesla, Irvine, CA 92618, USA  Website: <a href="http://www.ainfoinc.com">www.ainfoinc.com</a>  Email: <a href="mailto:sales@ainfoinc.com">sales@ainfoinc.com</a></li> </ul>	<ul style="list-style-type: none"> <li>• <b>Phone &amp; Fax</b> Phone: +1-949-639-9688 +1-949-639-9608  Fax: +1-949-639-9670</li> </ul>
---	--	---