

LB-475110-10-A Multi Octave Horn Antenna 4.75-11GHz 10dB Gain Double Ridge Waveguide Interface



Multi Octave Horn Antenna From 4.75GHz to 11GHz With a Nominal 10dB Gain With Double Ridge Waveguide Interface

Product Information

| | |
|-----|----------------|
| SKU | LB-475110-10-A |
|-----|----------------|

Description

Multi octave horn antenna LB-475110-10-A, operating from 4.75 to 11GHz with a nominal 10dB gain and low VSWR 1.5:1 with FPWRD475D24 output. The model LB-475110-10-A has uniform gain through its frequency span, providing efficient performance characteristics and directionality. Constructed of lightweight corrosion-resistant aluminum, the antenna will provide years of trouble-free indoor and outdoor service. This multi octave horn antenna is linearly polarized and ideally suited for EMI testing, direction finding, surveillance, antenna gain and pattern measurements and other applications.

Technical Specification

| Electrical Specification | | Interface | |
|------------------------------------|--------------|--------------------------|---|
| Frequency, Min (GHz) | 4.75 | Output Type | Waveguide |
| Frequency, Max (GHz) | 11 | Flange Designation, WRD | FPWRD475D24 |
| Waveguide Type | Double Ridge | Connector Gender | N/A |
| Waveguide Size EIA WRD | WRD475 | Mechanical Specification | |
| Gain, Typ (dBi) | 10 | Figure | A Type |
| Polarization | Linear | Body Material | Al |
| 3dB Beamwidth, E-Plane, Min (Deg.) | 26 | Finish | Chemical Conversion Coating, Gray Paint |
| 3dB Beamwidth, E-Plane, Max (Deg.) | 67 | Size, W (mm) | 73 |
| 3dB Beamwidth, H-Plane, Min (Deg.) | 27 | Size, H (mm) | 58 |
| 3dB Beamwidth, H-Plane, Max (Deg.) | 65 | Size, L (mm) | 105 |
| Cross Pol. Isolation, Typ (dB) | 40 | Weight, (kg) | 0.12 |
| VSWR, Typ | 1.5:1 | | |

Additional Information

| | | | |
|-------------|---|--------------|---|
| Application | General Purpose Indoor & Outdoor, Fixed | Solution for | Gain Reference Antenna Measurement Far-field Measurement System Intergration |
|-------------|---|--------------|---|

Outline Drawing

FPWRD475D24 Output (P/N: LB-475110-10-A)

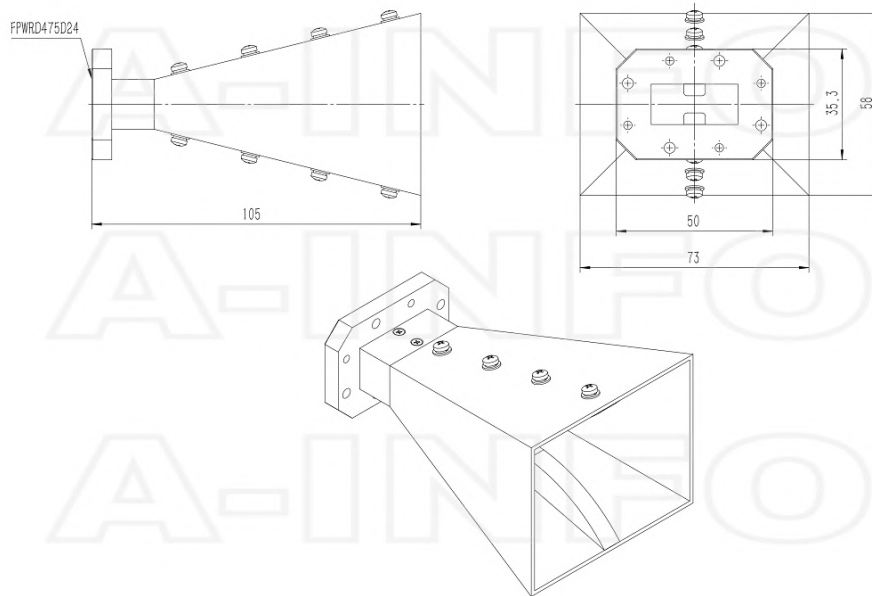

Flange Drawing

FPWRD475D24

(With four through mounting holes and four screws holes)

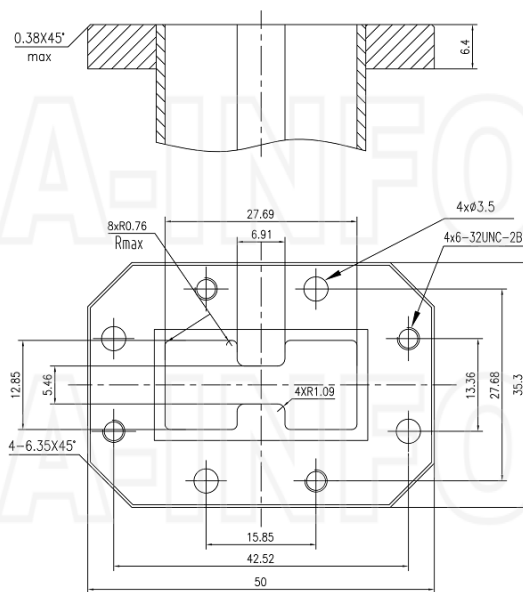

Typical Test Results

Gain

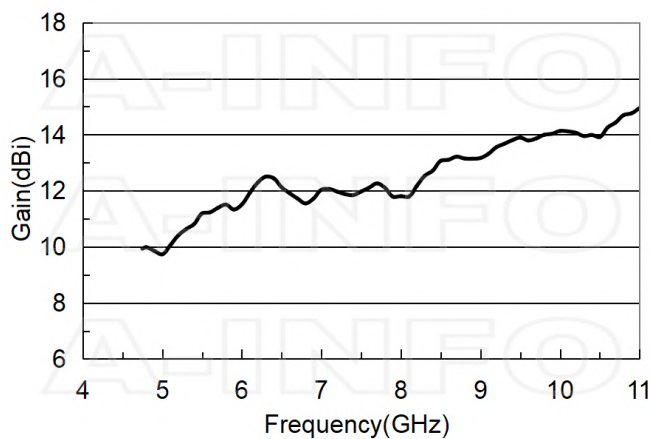

Antenna Factor

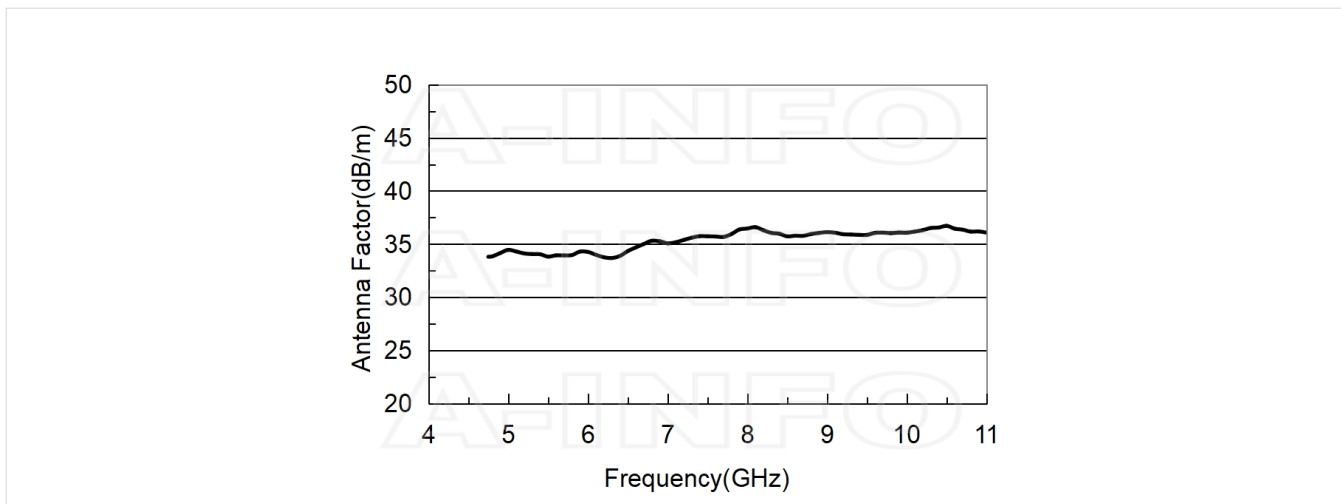

Antenna Factor (Table)

| Frequency(GHz) | Gain(dBi) | AF(dB/m) |
|----------------|-----------|----------|
| 4.75 | 9.93 | 33.81 |
| 5.0 | 9.73 | 34.46 |
| 5.5 | 11.19 | 33.83 |
| 6.0 | 11.51 | 34.27 |
| 6.5 | 12.12 | 34.35 |
| 7.0 | 12.03 | 35.08 |
| 7.5 | 11.97 | 35.74 |
| 8.0 | 11.80 | 36.47 |
| 8.5 | 13.06 | 35.73 |
| 9.0 | 13.17 | 36.13 |
| 9.5 | 13.90 | 35.87 |
| 10.0 | 14.13 | 36.08 |
| 10.5 | 13.92 | 36.72 |
| 11.0 | 14.95 | 36.09 |

Cross Polarization Isolation

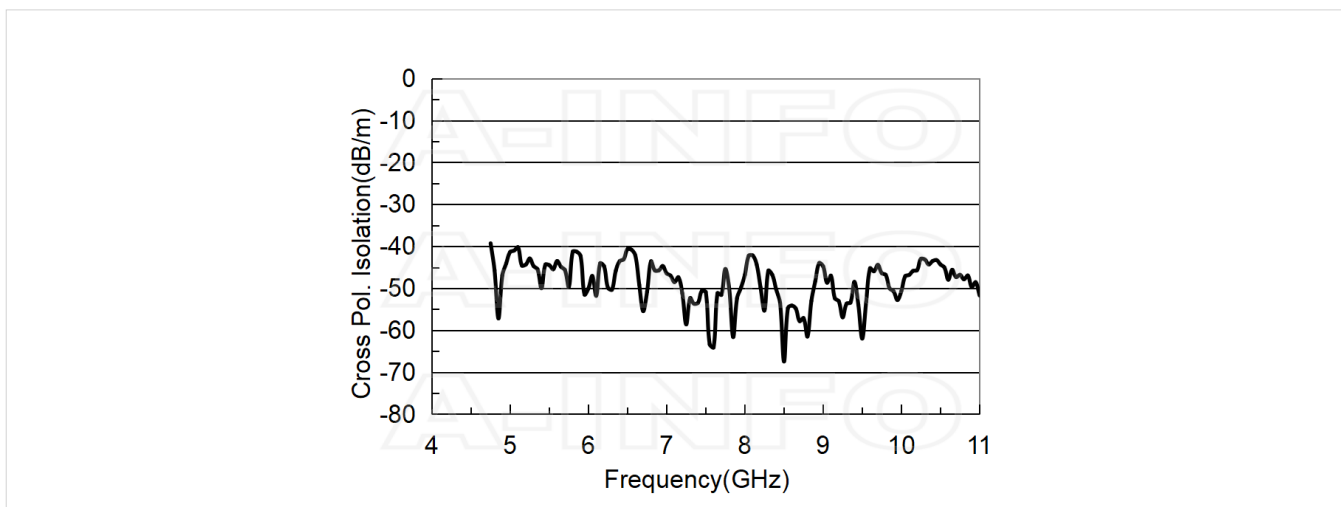

VSWR

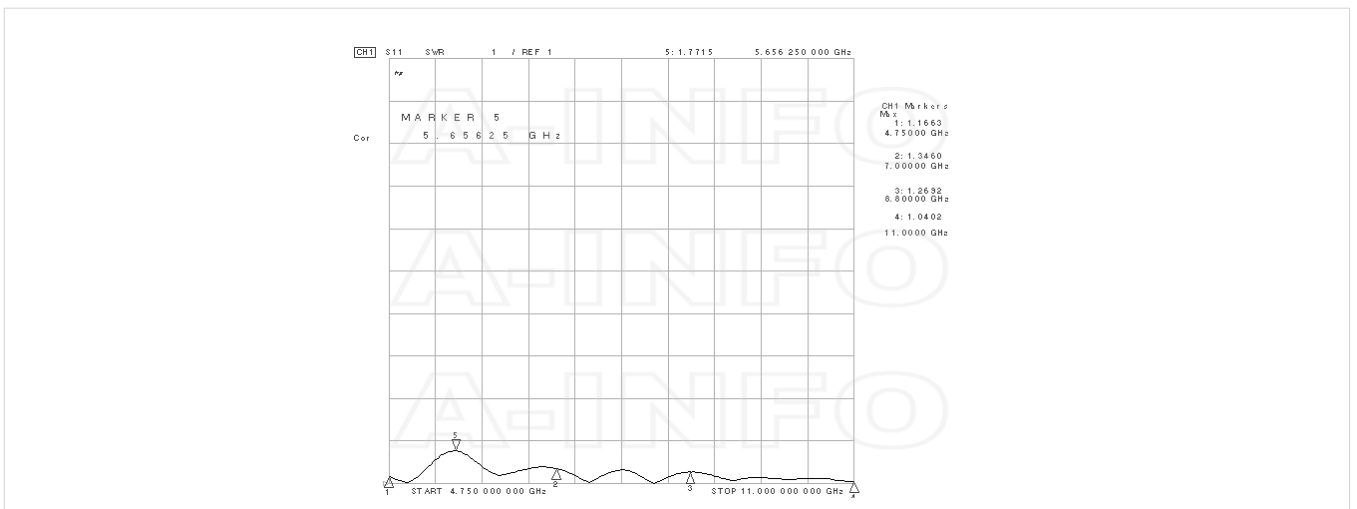

Beamwidth

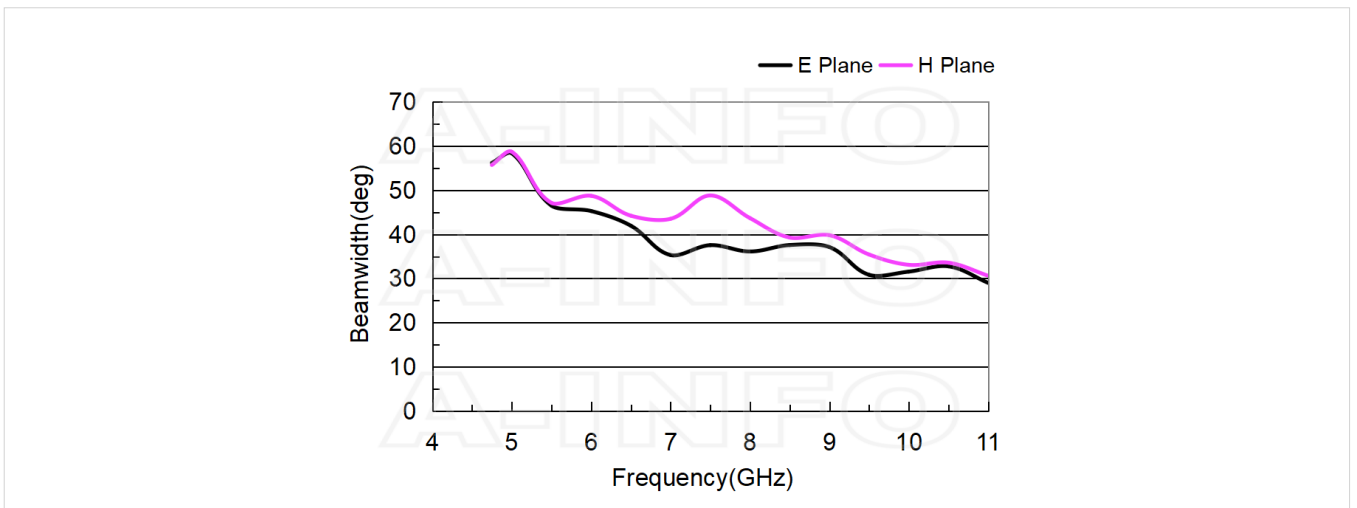

Pattern

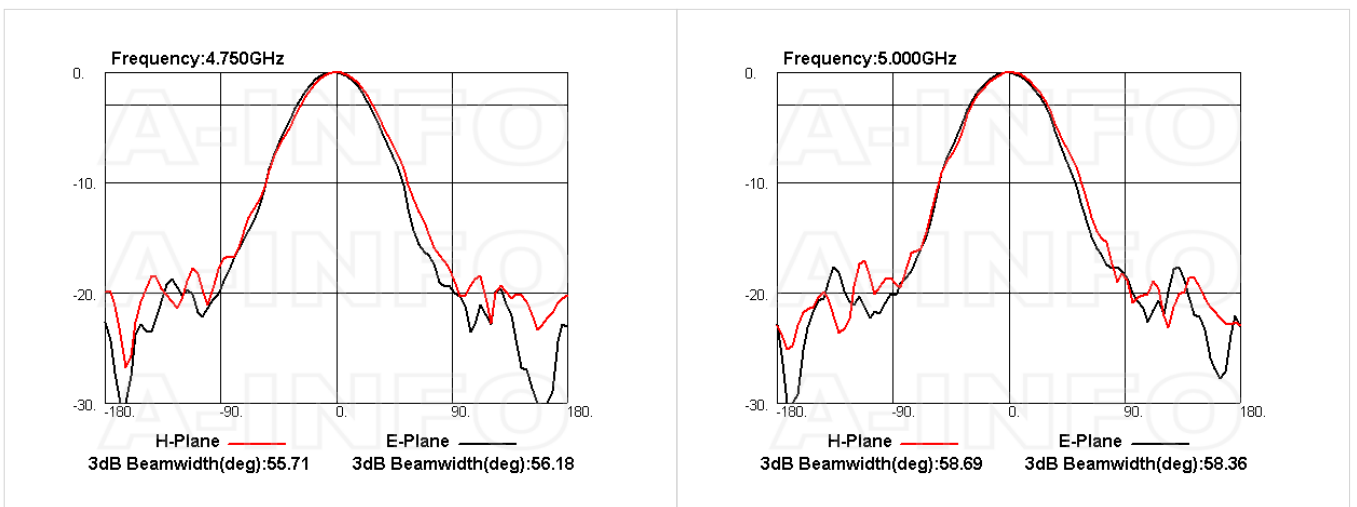

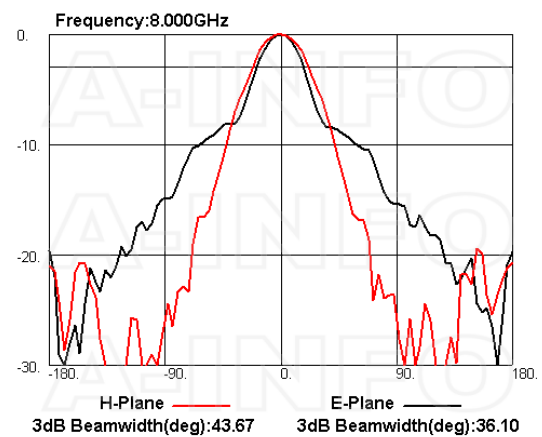
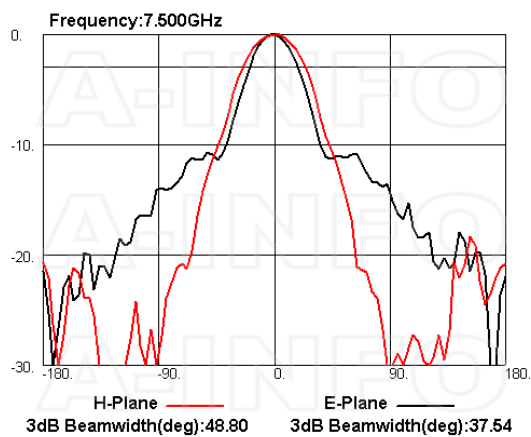
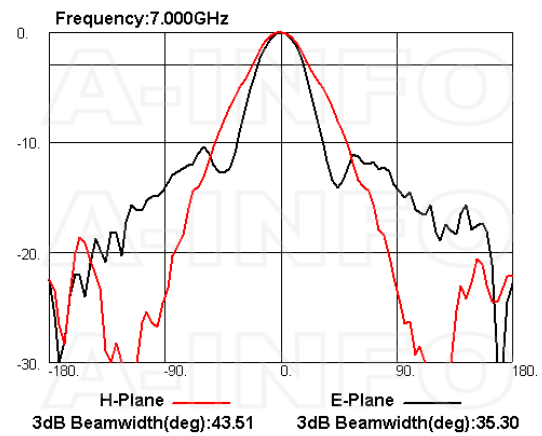
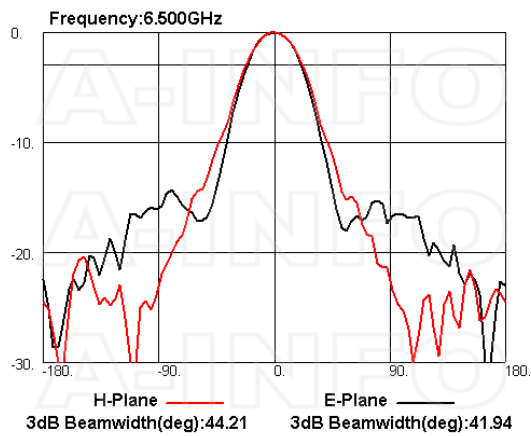
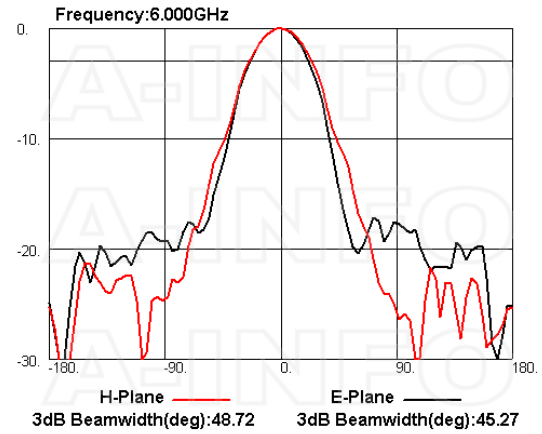
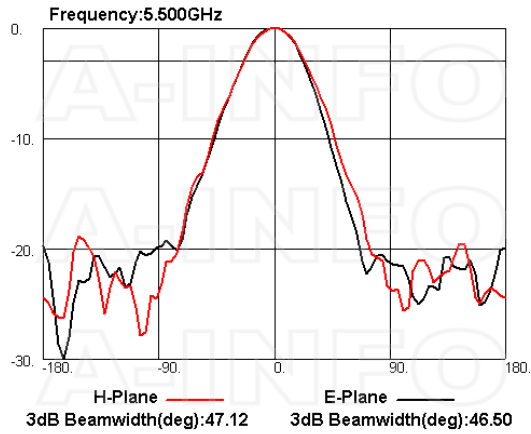

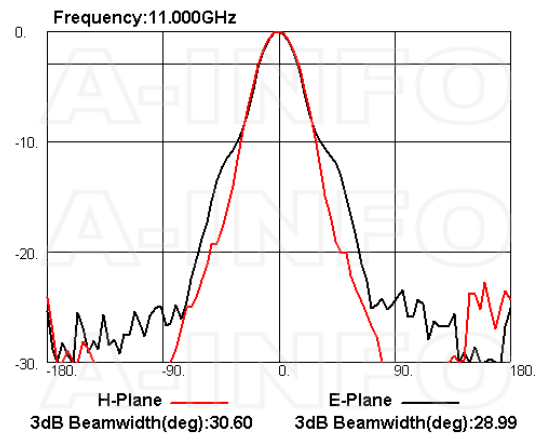
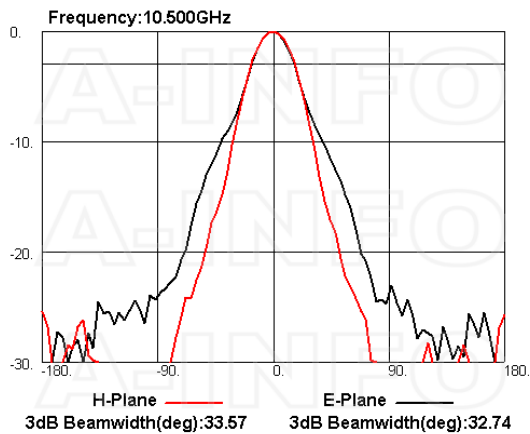
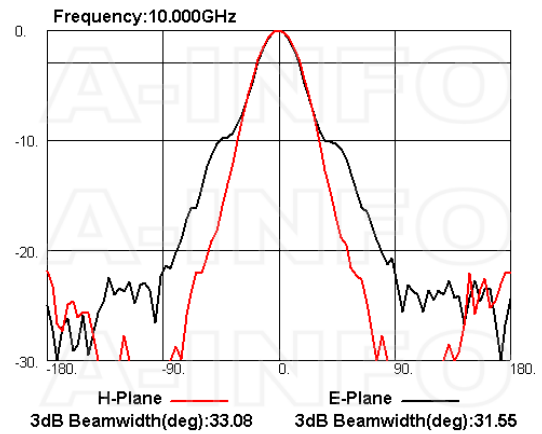
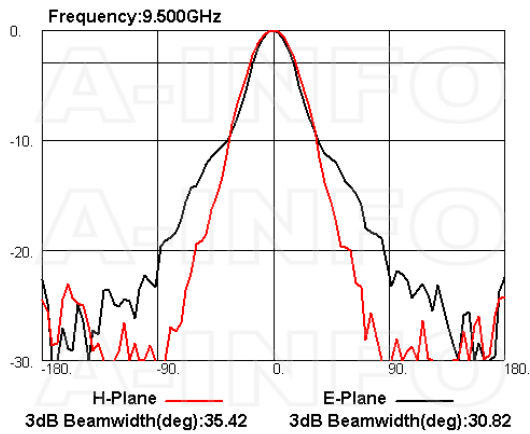
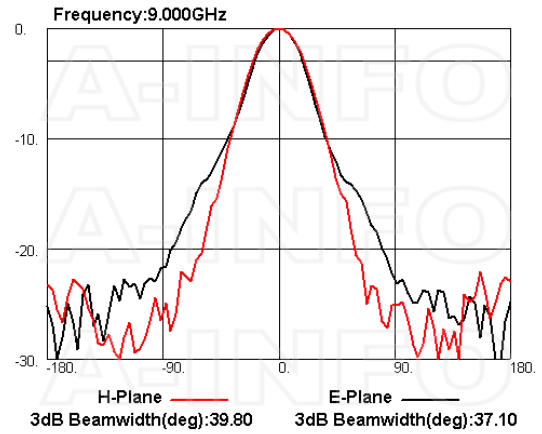
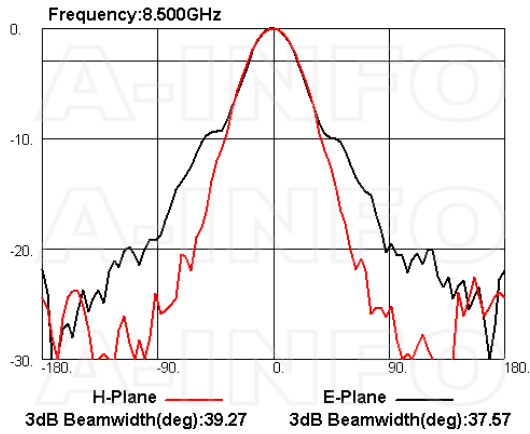

Related Products



475DRWCAN Right Angle Double Ridge Waveguide to Coaxial Adapter 4.75-11GHz WRD475 to N Type Female



475DRWCAS Right Angle Double Ridge Waveguide to Coaxial Adapter 4.75-11GHz WRD475 to SMA Female



475DRWECAN Endlaunch Double Ridge Waveguide to Coaxial Adapter 4.75-11GHz WRD475 to N Type Female



475DRWECAS Endlaunch Double Ridge Waveguide to Coaxial Adapter 4.75-11GHz WRD475 to SMA Female



475DRWHCAN Right Angle High Power Double Ridge Waveguide to Coaxial Adapter 4.75-11GHz WRD475 to N Type Female



LB-475110-10-C-MB Round Type Mounting Bracket



LB-475110-10-C-MBL L type mounting bracket



Tripod_15Kg Al Alloy Tripod



3033HL Wooden Tripod



3033QM Wooden Tripod Metalfree

Similar Products



LB-475110-10-ASPO Multi Octave Horn Antenna 4.75-11GHz 10dB Gain Double Ridge Waveguide Interface



LB-475110-10-C-NF Multi Octave Horn Antenna 4.75-11GHz 10dB Gain N Type Female

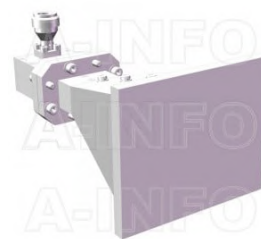

LB-475110-10-C-NFSPO Multi Octave Horn Antenna 4.75-11GHz 10dB Gain N Type Female



LB-475110-10-C-SF Multi Octave Horn Antenna 4.75-11GHz 10dB Gain SMA Female

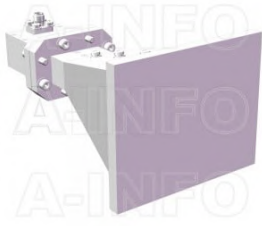

LB-475110-10-C-SFSP0 Multi Octave Horn Antenna
4.75-11GHz 10dB Gain SMA Female

About this Datasheet

| | | |
|---|--|---|
| <ul style="list-style-type: none"> • Product Information Product Link: https://www.ainfoinc.com/lb-475110-10-a-multi-octave-horn-antenna-4-75-11-ghz-10db-gain-fpwr475d24 Data subject to change without notice. © A-INFO INC. 2024. All Rights Reserved | <ul style="list-style-type: none"> • Contact Us Address: 60 Tesla, Irvine, CA 92618, USA Website: www.ainfoinc.com Email: sales@ainfoinc.com | <ul style="list-style-type: none"> • Phone & Fax Phone: +1-949-639-9688 +1-949-639-9608 Fax: +1-949-639-9670 |
|---|--|---|