

LB-3582-10-C-ENF Multi Octave Horn Antenna 3.5-8.2GHz 10dB Gain
Endlaunch N Type Female

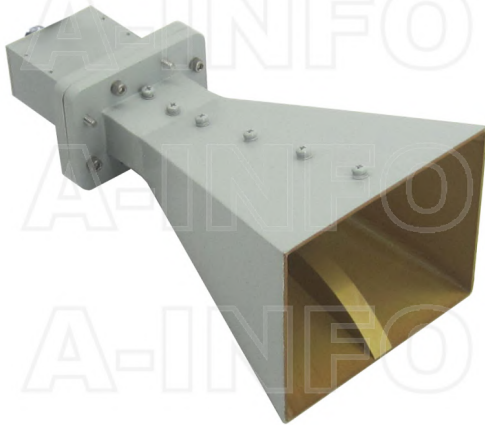

Multi Octave Horn Antenna Operating From 3.5GHz to 8.2GHz With a Nominal 10dB Gain With Endlaunch N Type Female Connector

Product Information

| | |
|-----|------------------|
| SKU | LB-3582-10-C-ENF |
|-----|------------------|

Description

Multi octave horn antenna LB-3582-10-C-ENF, operating from 3.5 to 8.2GHz with a nominal 10dB gain and low VSWR 1.5:1 with Endlaunch N Type Female output connector. The model LB-3582-10-C-ENF has uniform gain through its frequency span, providing efficient performance characteristics and directionality. It can handle 150W continuously and 3000W peak power. Constructed of lightweight corrosion-resistant aluminum, the antenna will provide years of trouble-free indoor and outdoor service. This multi octave horn antenna is linearly polarized and ideally suited for EMI testing, direction finding, surveillance, antenna gain and pattern measurements and other applications.

Technical Specification

| Electrical Specification | | Interface | |
|------------------------------------|--------------|--------------------------|---|
| Frequency, Min (GHz) | 3.5 | Output Type | Coaxial |
| Frequency, Max (GHz) | 8.2 | Connector | N Type |
| Waveguide Type | Double Ridge | Connector Gender | Female |
| Waveguide Size EIA WRD | WRD350 | Mechanical Specification | |
| Gain, Typ (dBi) | 10 | Figure | C Type |
| Polarization | Linear | Body Material | Al |
| 3dB Beamwidth, E-Plane, Min (Deg.) | 24 | Finish | Chemical Conversion Coating, Gray Paint |
| 3dB Beamwidth, E-Plane, Max (Deg.) | 60 | Size, W (mm) | 103 |
| 3dB Beamwidth, H-Plane, Min (Deg.) | 24 | Size, H (mm) | 83 |
| 3dB Beamwidth, H-Plane, Max (Deg.) | 62 | Size, L (mm) | 232.1 |
| Cross Pol. Isolation, Typ (dB) | 40 | Weight, (kg) | 0.34 |
| VSWR, Typ | 1.5:1 | | |
| Impedance, (Ohm) | 50 | | |
| Power Handling, CW, (W) | 150 | | |
| Power Handling, Peak, (W) | 3000 | | |

Additional Information

| | | | |
|-------------|---|--------------|---|
| Application | General Purpose Indoor & Outdoor, Fixed | Solution for | Gain Reference Antenna Measurement Far-field Measurement System Intergration |
|-------------|---|--------------|---|

Outline Drawing

Endlaunch N-Female Output (P/N: LB-3582-10-C-ENF)

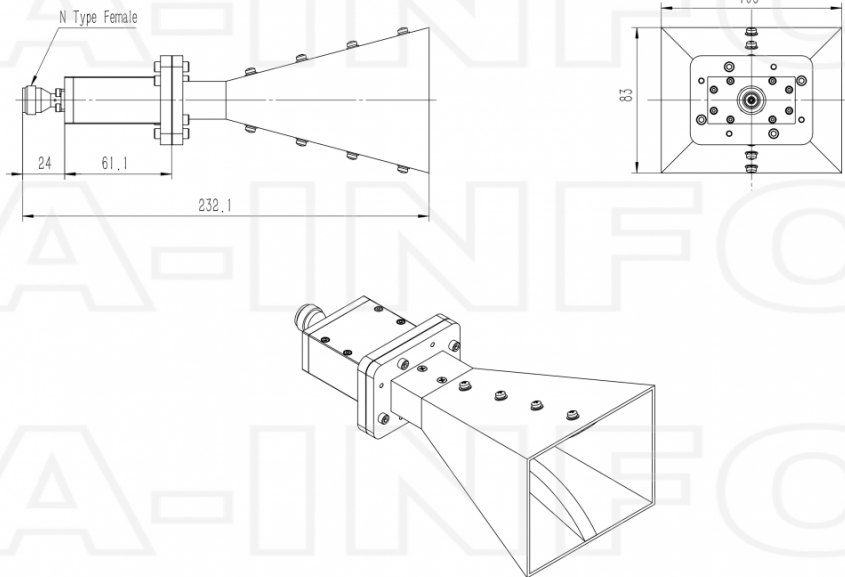

Typical Test Results

Gain

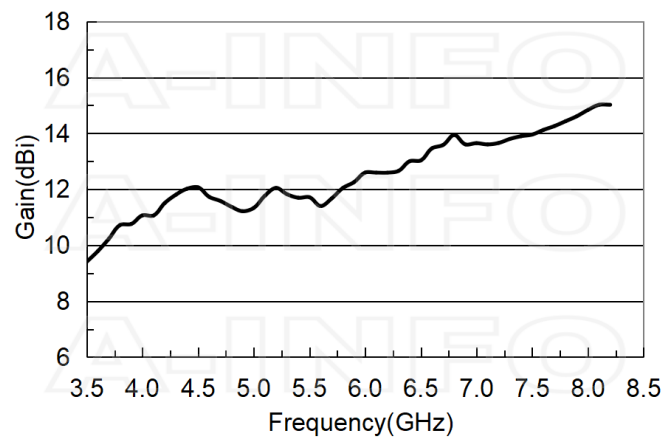

Antenna Factor

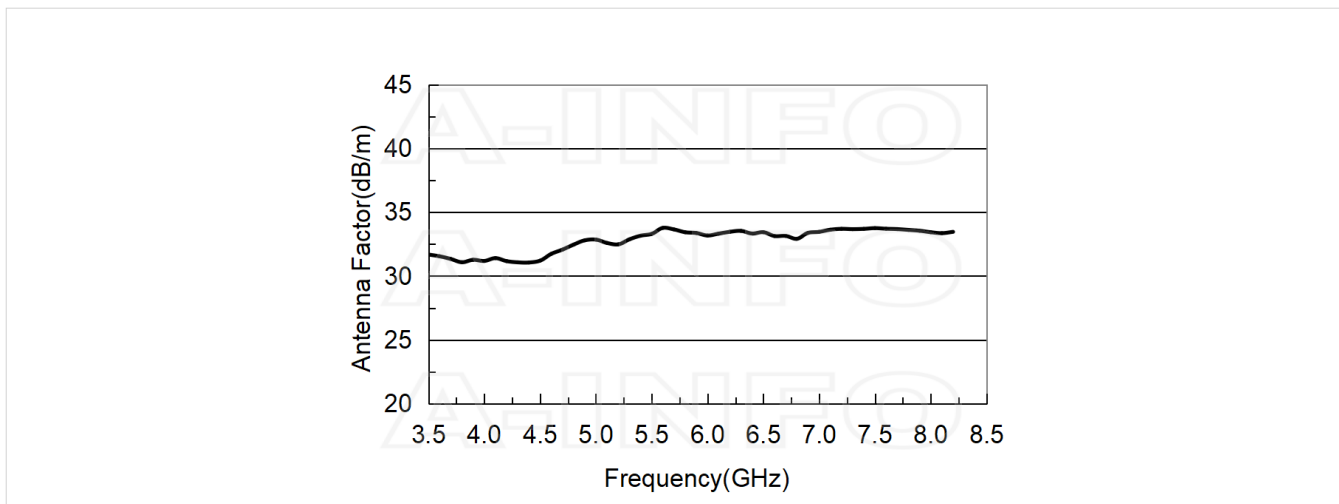

Antenna Factor (Table)

| Frequency(GHz) | Gain(dBi) | AF(dB/m) |
|----------------|-----------|----------|
| 3.5 | 9.41 | 31.68 |
| 4.0 | 11.07 | 31.18 |
| 4.5 | 12.07 | 31.21 |
| 5.0 | 11.33 | 32.85 |
| 5.5 | 11.71 | 33.30 |
| 6.0 | 12.60 | 33.18 |
| 6.5 | 13.03 | 33.44 |
| 7.0 | 13.65 | 33.46 |
| 7.5 | 13.96 | 33.75 |
| 8.0 | 14.84 | 33.44 |
| 8.2 | 15.02 | 33.46 |

Cross Polarization Isolation

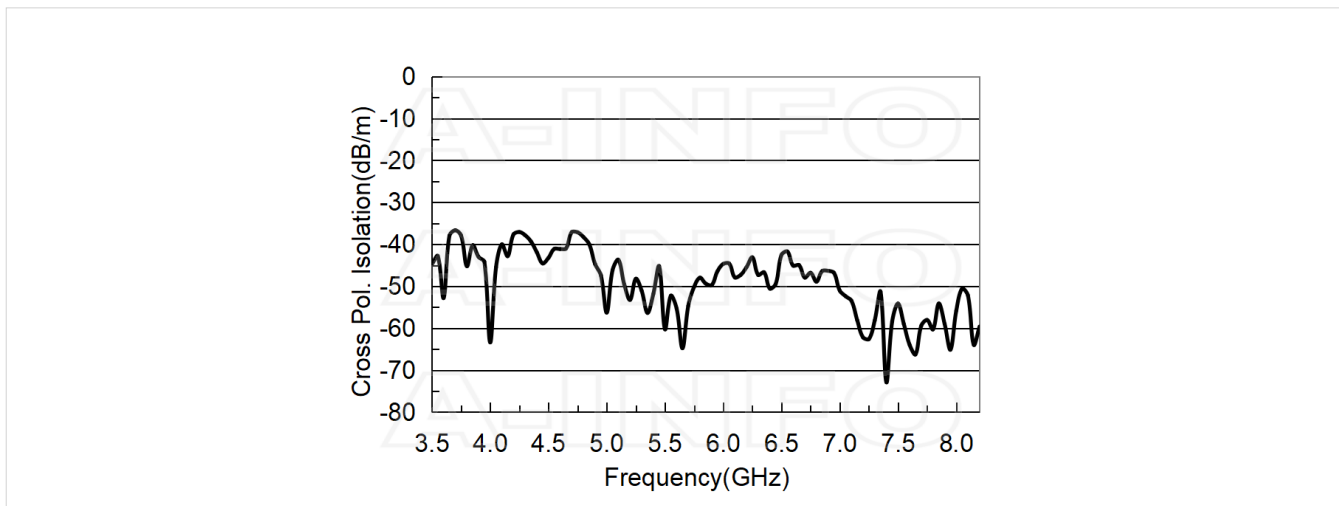

VSWR

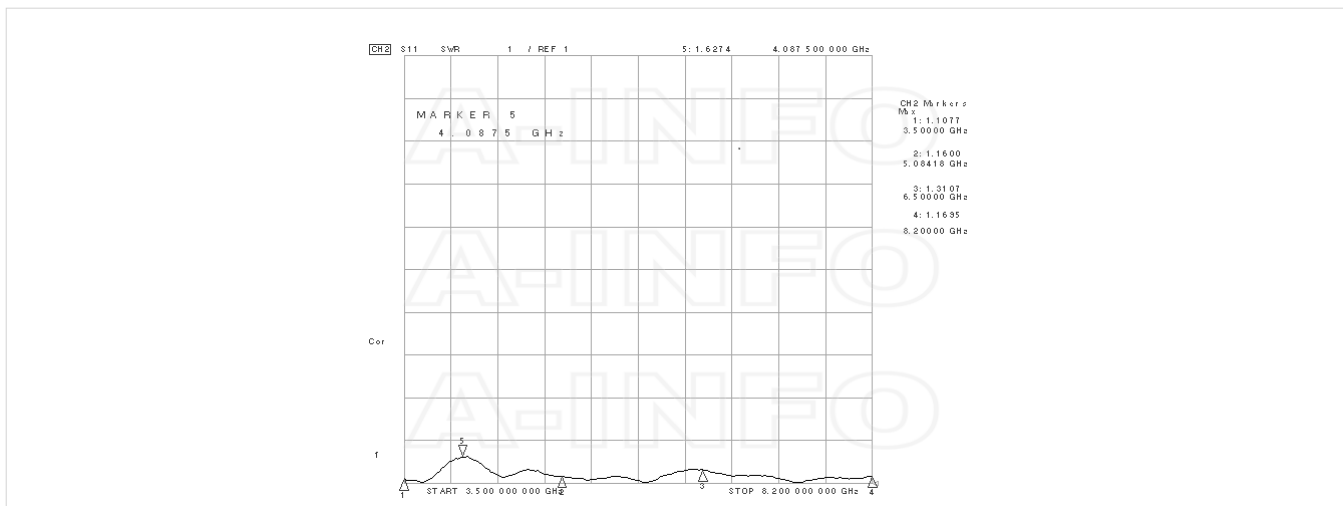

Beamwidth

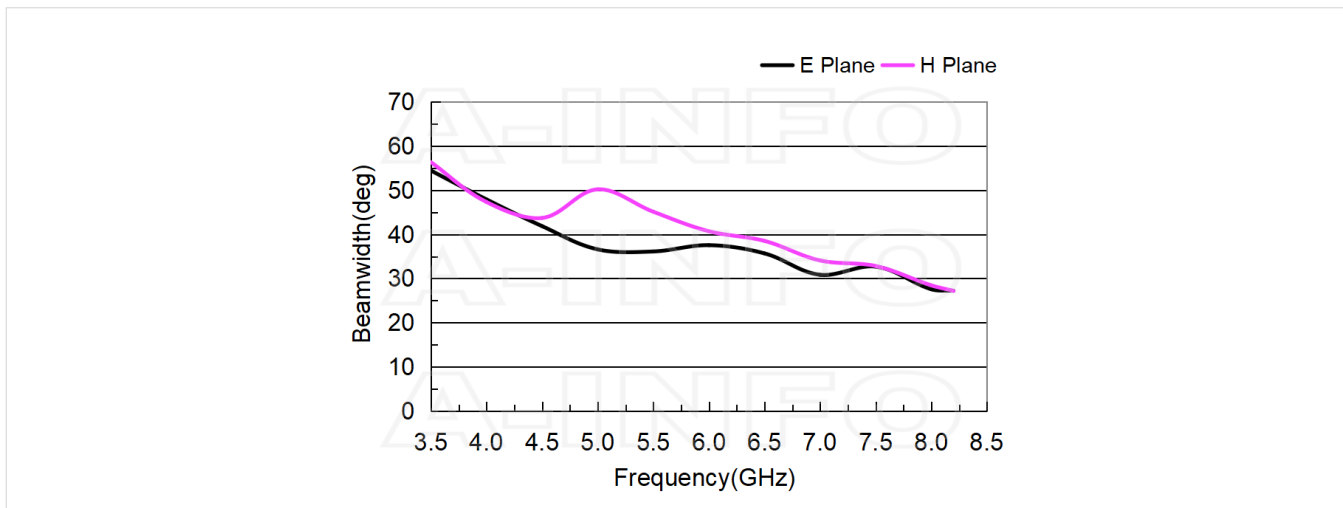

Pattern

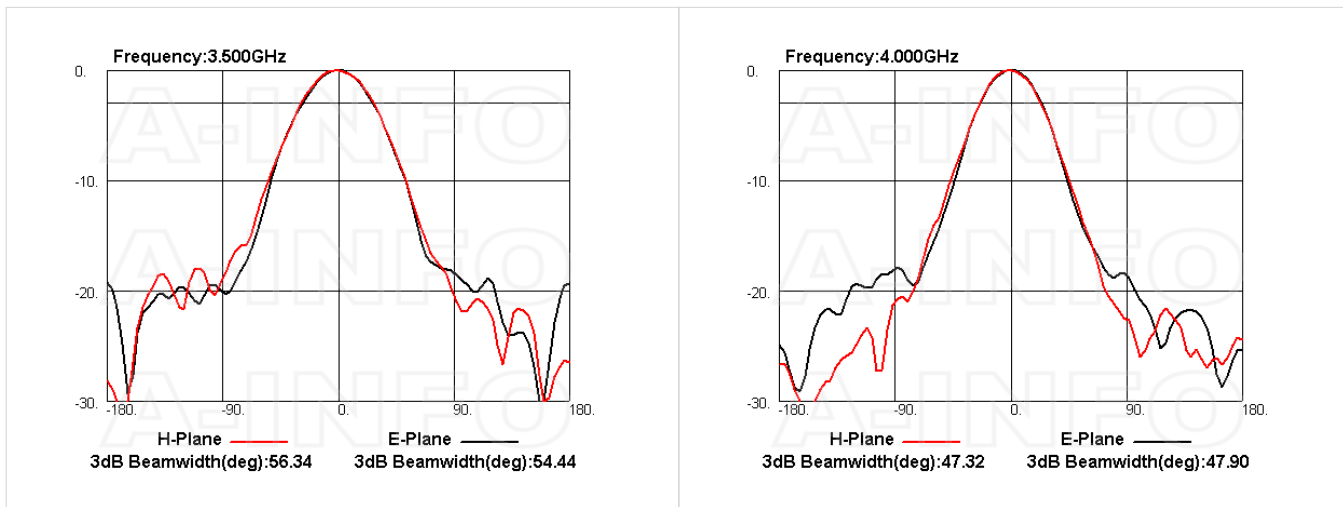

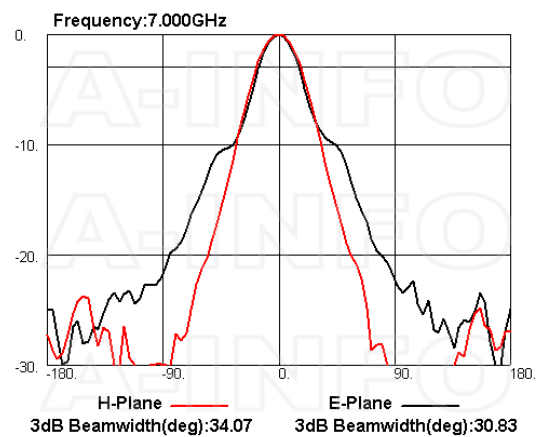
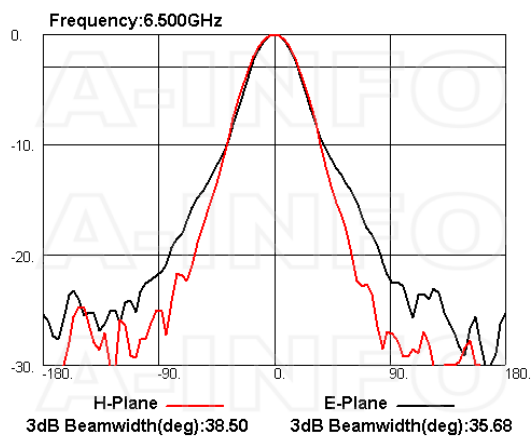
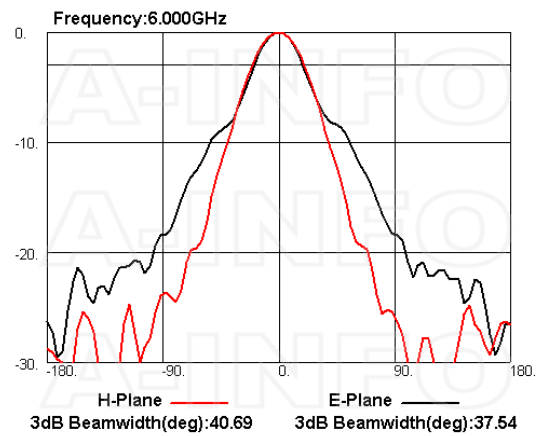
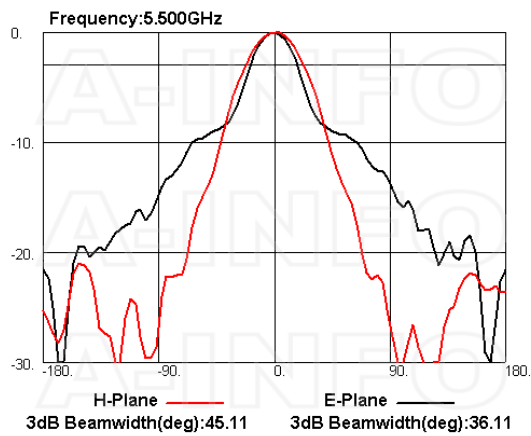
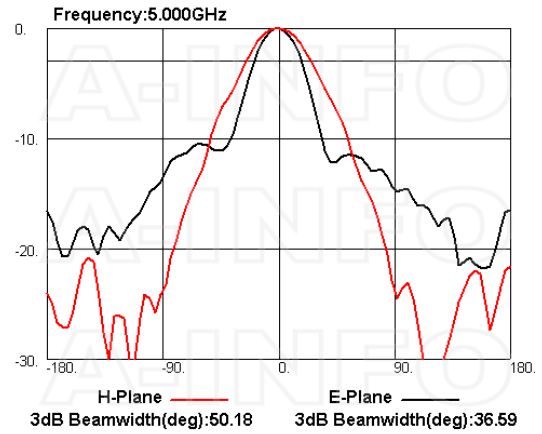
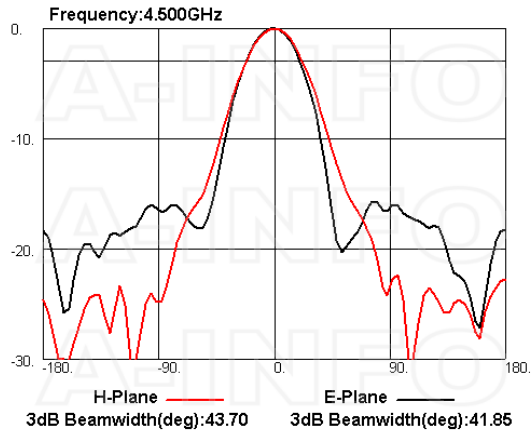

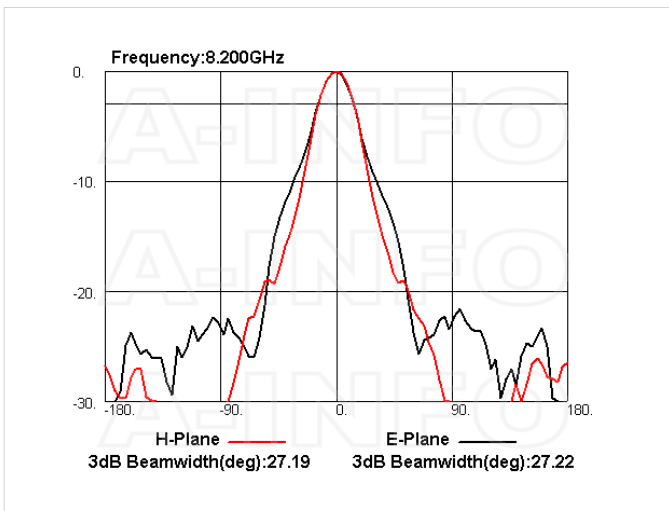
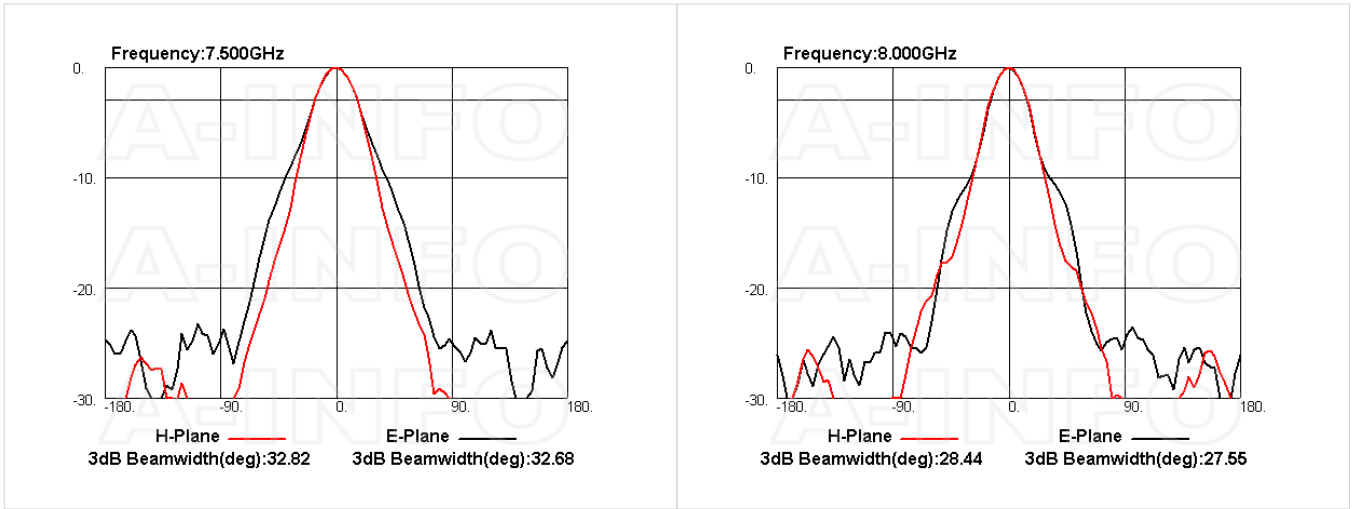

Related Products



NM-NM-A050-1000 Flexible Cable Assembly 1000mm DC-18GHz N Male to N Male



NM-NM-A050-1500 Flexible Cable Assembly 1500mm DC-18GHz N Male to N Male



NM-NM-A050-2000 Flexible Cable Assembly 2000mm DC-18GHz N Male to N Male



NM-NM-A050-3000 Flexible Cable Assembly 3000mm DC-18GHz N Male to N Male



NM-NM-A050-5000 Flexible Cable Assembly 5000mm DC-18GHz N Male to N Male



NM-NM-A050-10000 Flexible Cable Assembly 10000mm DC-18GHz N Male to N Male



NM-NM-A050-20000 Flexible Cable Assembly 20000mm DC-18GHz N Male to N Male



NM-NM-A100-500 Flexible Cable Assembly 500mm DC-18GHz N Male to N Male



NM-NM-A100-1000 Flexible Cable Assembly 1000mm DC-18GHz N Male to N Male



NM-NM-A100-1500 Flexible Cable Assembly 1500mm DC-18GHz N Male to N Male



NM-NM-A100-2000 Flexible Cable Assembly 2000mm DC-18GHz N Male to N Male



NM-NM-A100-3000 Flexible Cable Assembly 3000mm DC-18GHz N Male to N Male



NM-NM-A100-5000 Flexible Cable Assembly 5000mm DC-18GHz N Male to N Male



NM-NM-A100-10000 Flexible Cable Assembly 10000mm DC-18GHz N Male to N Male



NM-NM-A100-20000 Flexible Cable Assembly 20000mm DC-18GHz N Male to N Male

Similar Products

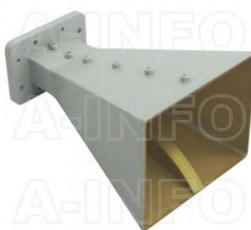

LB-3582-10-A Multi Octave Horn Antenna 3.5-8.2GHz 10dB Gain Double Ridge Waveguide Interface

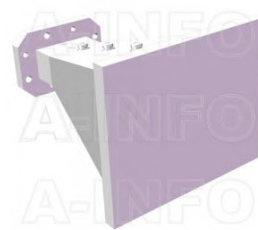

LB-3582-10-ASPO Multi Octave Horn Antenna 3.5-8.2GHz 10dB Gain Double Ridge Waveguide Interface



LB-3582-10-C-NF Multi Octave Horn Antenna 3.5-8.2GHz 10dB Gain N Type Female

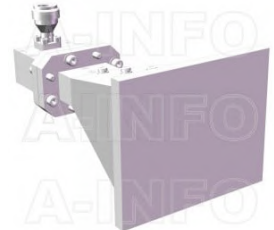

LB-3582-10-C-NFSP0 Multi Octave Horn Antenna 3.5-8.2GHz 10dB Gain N Type Female



LB-3582-10-C-SF Multi Octave Horn Antenna 3.5-8.2GHz 10dB Gain SMA Female

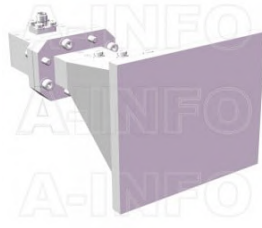

LB-3582-10-C-SFSP0 Multi Octave Horn Antenna 3.5-8.2GHz 10dB Gain SMA Female



LB-3582-10-C-ESF Multi Octave Horn Antenna 3.5-8.2GHz 10dB Gain Endlaunch SMA Female

About this Datasheet

| | | |
|---|--|---|
| <ul style="list-style-type: none"> ● Product Information Product Link: https://www.ainfoinc.com/lb-3582-10-c-enf-multi-octave-horn-antenna-3-5-8-2-ghz-10db-gain-endlaunch-n-type-female Data subject to change without notice. © A-INFO INC. 2024. All Rights Reserved | <ul style="list-style-type: none"> ● Contact Us Address: 60 Tesla, Irvine, CA 92618, USA Website: www.ainfoinc.com Email: sales@ainfoinc.com | <ul style="list-style-type: none"> ● Phone & Fax Phone: +1-949-639-9688 +1-949-639-9608 Fax: +1-949-639-9670 |
|---|--|---|