

LB-2678-15-ASPO Multi Octave Horn Antenna 2.6-7.8GHz 15dB Gain  
Double Ridge Waveguide Interface

Multi Octave Horn Antenna From 2.6GHz to 7.8GHz With a Nominal 15dB Gain With Double Ridge Waveguide Interface

### Product Information

SKU	LB-2678-15-ASPO
-----	-----------------

### Description

Multi octave horn antenna LB-2678-15-ASPO, operating from 2.6 to 7.8GHz with a nominal 15dB gain and low VSWR 1.5:1 with FPWRD250D30 output. The model LB-2678-15-ASPO has uniform gain through its frequency span, providing efficient performance characteristics and directionality. Constructed of lightweight corrosion-resistant aluminum, the horn comes with a specially designed weatherproof radome which provides excellent protection against the rain and dust but has very little loss across the full operating frequency band. This multi octave horn antenna is linearly polarized and ideally suited for EMI testing, direction finding, surveillance, antenna gain and pattern measurements and other applications.

### Technical Specification

Electrical Specification		Interface	
Frequency, Min (GHz)	2.6	Output Type	Waveguide
Frequency, Max (GHz)	7.8	Flange Designation, WRD	FPWRD250D30
Waveguide Type	Double Ridge	Connector Gender	N/A
Waveguide Size EIA WRD	WRD250	Mechanical Specification	
Gain, Typ (dBi)	15	Figure	A Type
Polarization	Linear	Body Material	Al
3dB Beamwidth, E-Plane, Min (Deg.)	16	Finish	Chemical Conversion Coating, Gray Paint
3dB Beamwidth, E-Plane, Max (Deg.)	48	Size, W (mm)	240
3dB Beamwidth, H-Plane, Min (Deg.)	16	Size, H (mm)	170
3dB Beamwidth, H-Plane, Max (Deg.)	41	Size, L (mm)	319
Cross Pol. Isolation, Typ (dB)	40	Weight, (kg)	1.3
VSWR, Typ	1.5:1		

## Additional Information

Application	Outdoor, Waterproof and Dustproof, Fixed	Solution for	Gain Reference Antenna Measurement Far-field Measurement System Intergration
-------------	--	--------------	---

## Outline Drawing

FPWRD250D30 Output with Radome (Option, P/N: LB-2678-15-ASPO, Outdoor Application)

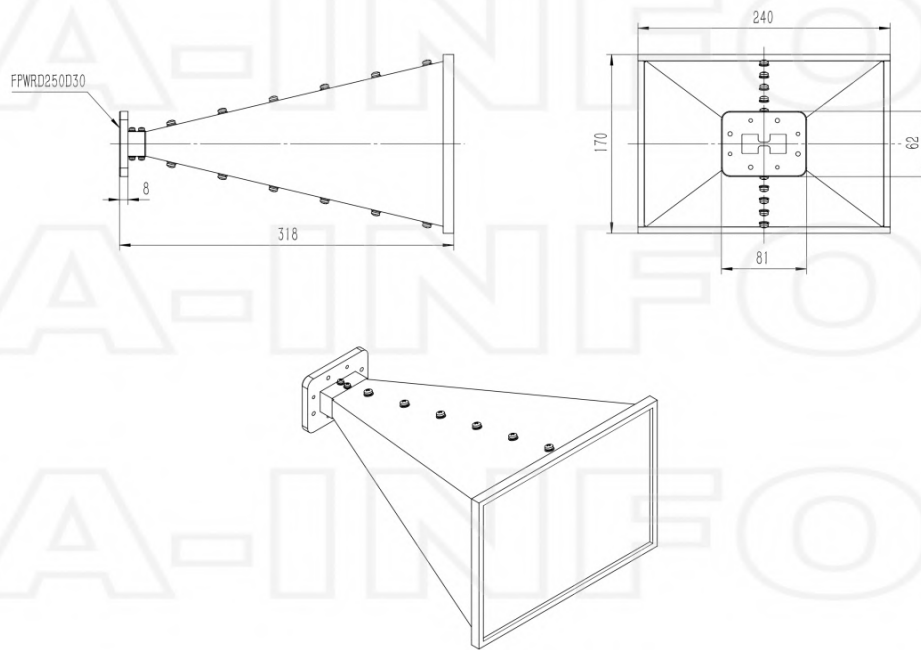

## Flange Drawing

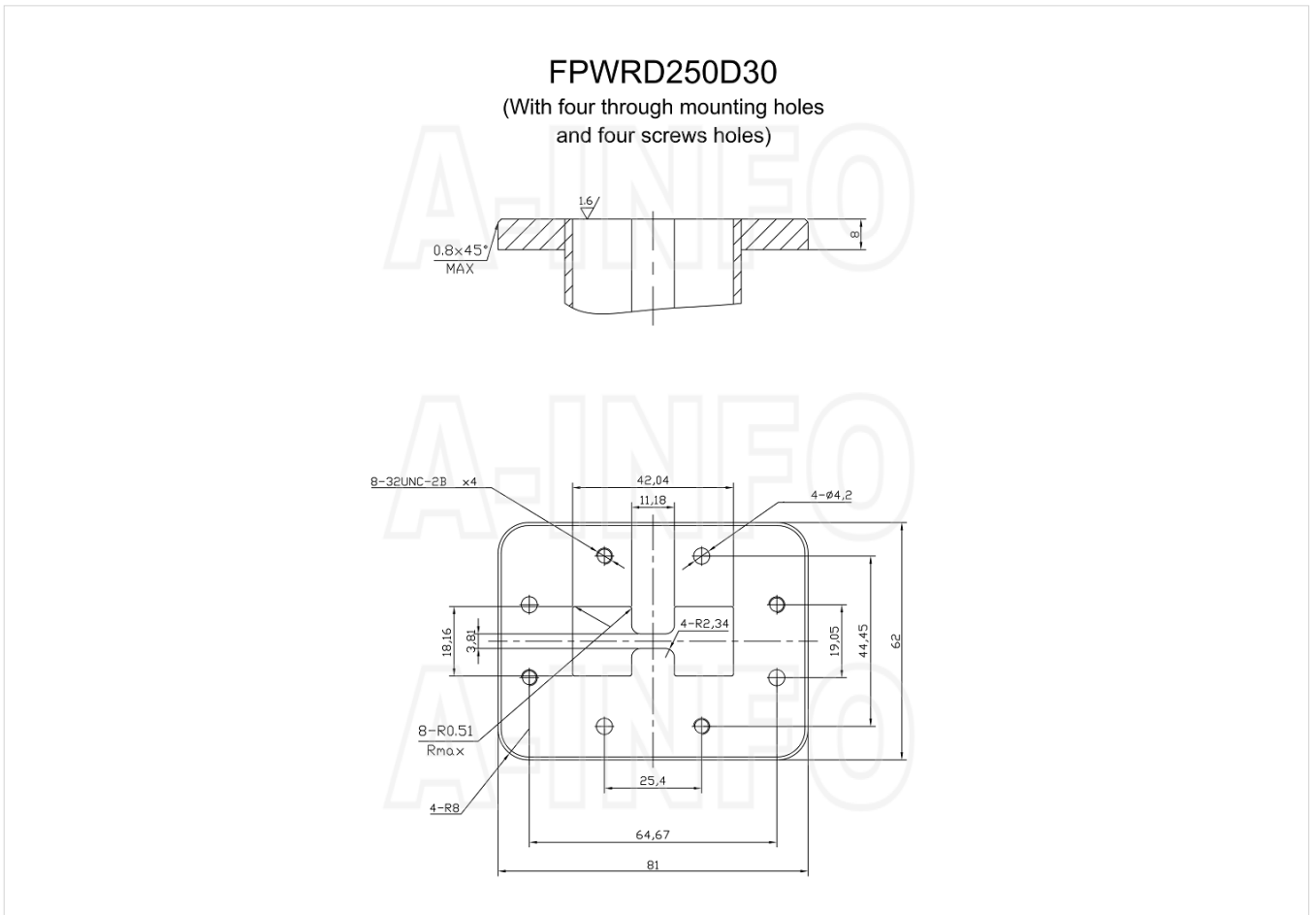

## Typical Test Results

Gain

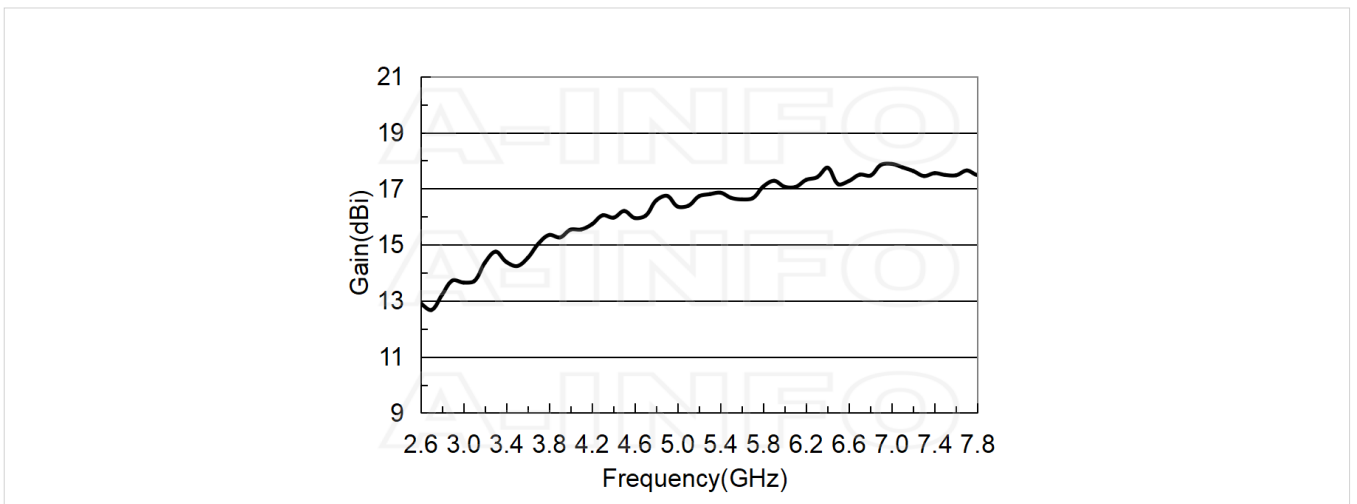

## Antenna Factor

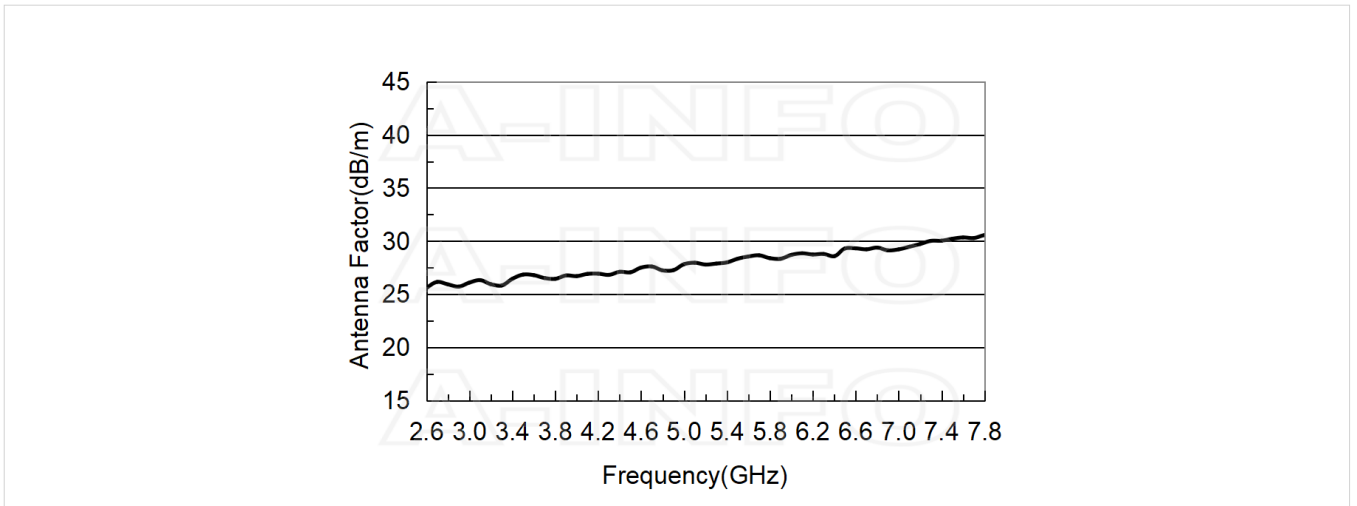

## Antenna Factor (Table)

Frequency(GHz)	Gain(dBi)	AF(dB/m)
2.6	12.91	25.60
3.0	13.65	26.10
3.5	14.24	26.85
4.0	15.54	26.71
4.5	16.20	27.07
5.0	16.36	27.83
5.5	16.67	28.35
6.0	17.06	28.71
6.5	17.15	29.31
7.0	17.88	29.23
7.5	17.49	30.22
7.8	17.48	30.57

## Cross Polarization Isolation

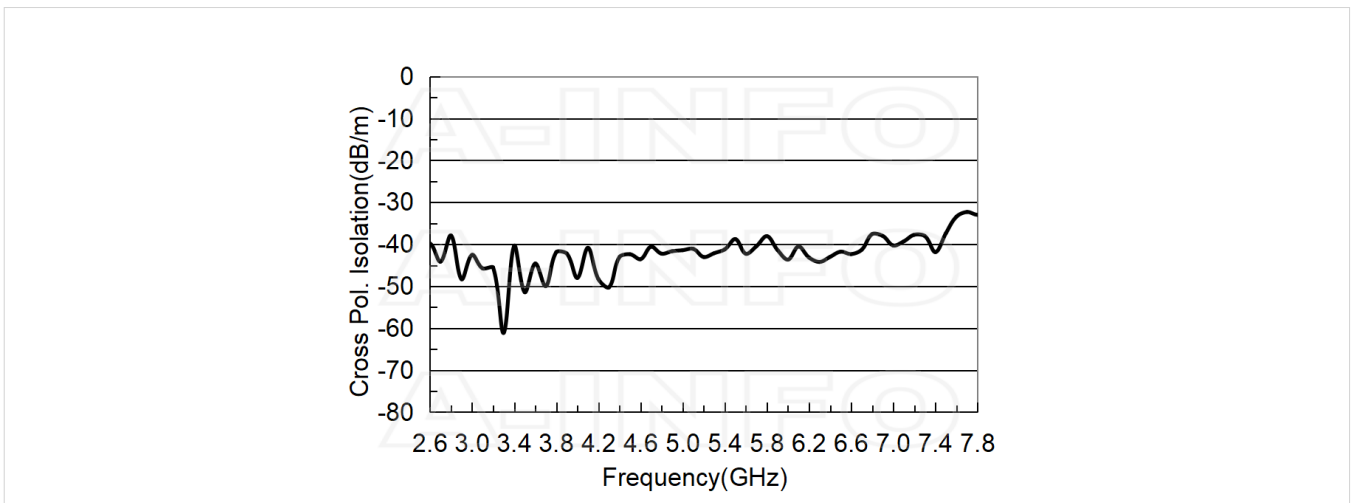

## VSWR

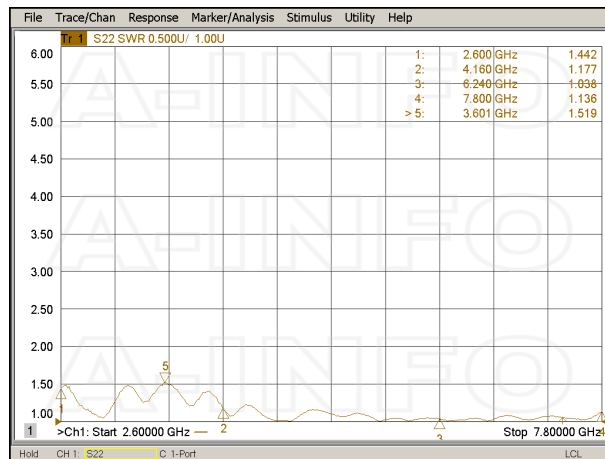

## Beamwidth

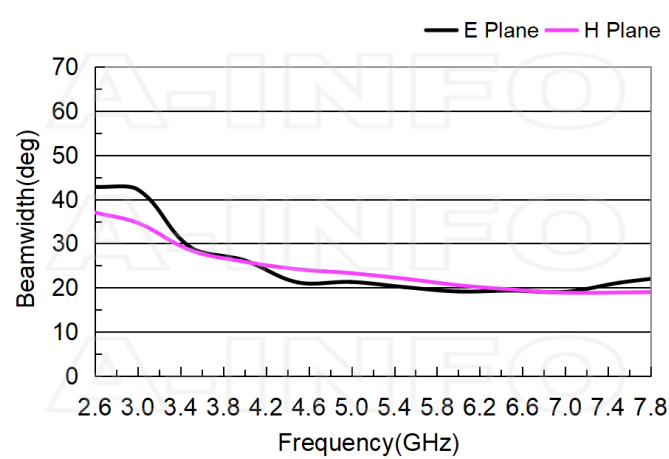

## Pattern

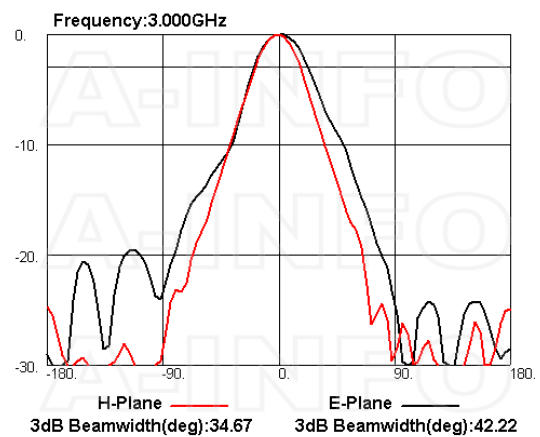
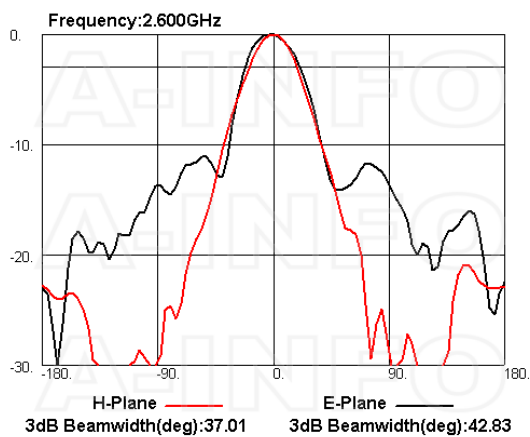

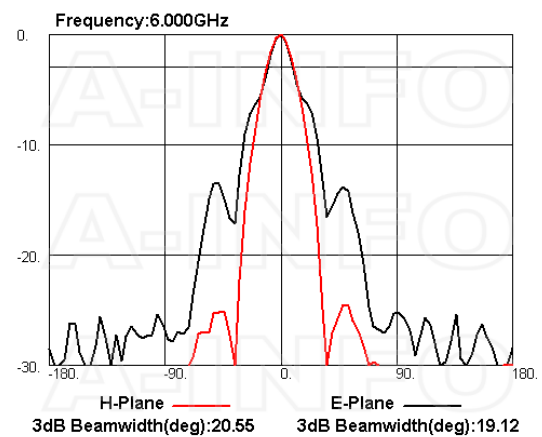
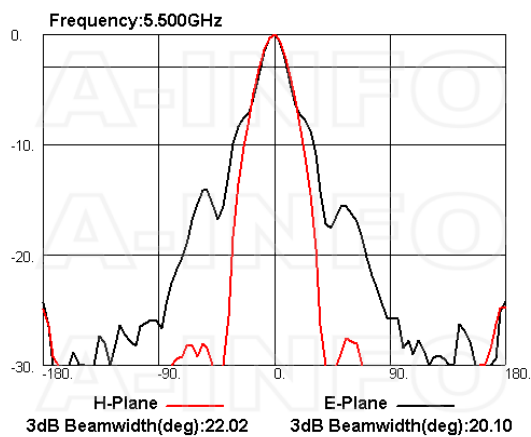
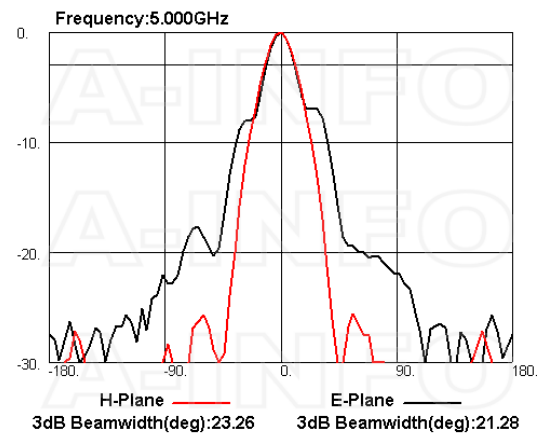
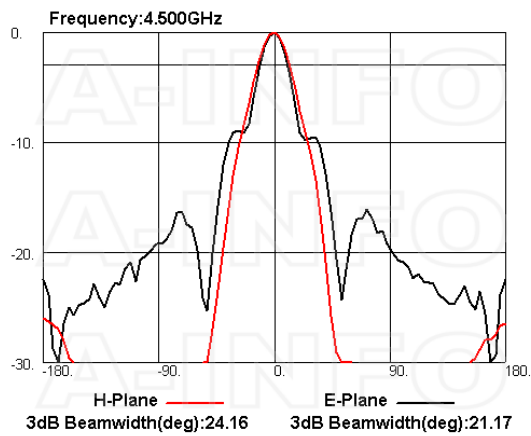
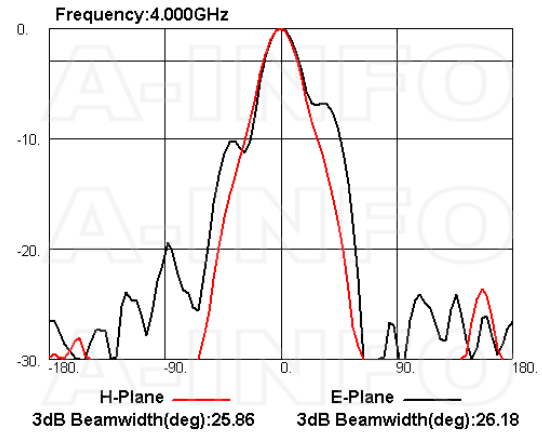
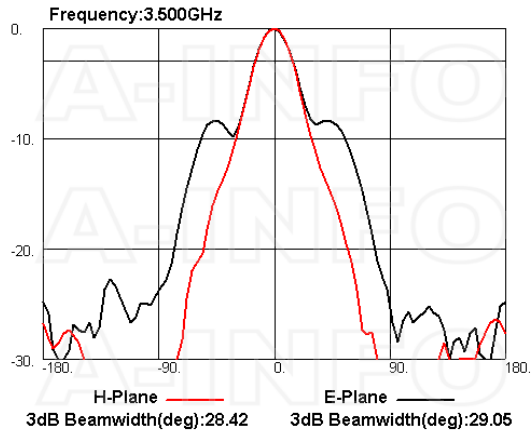

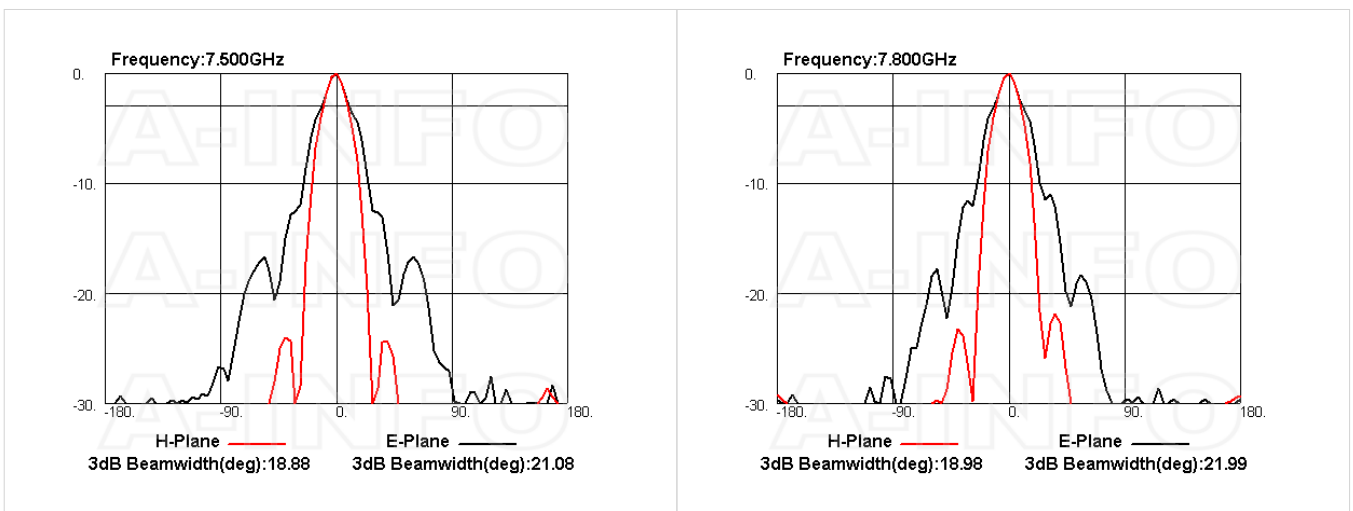
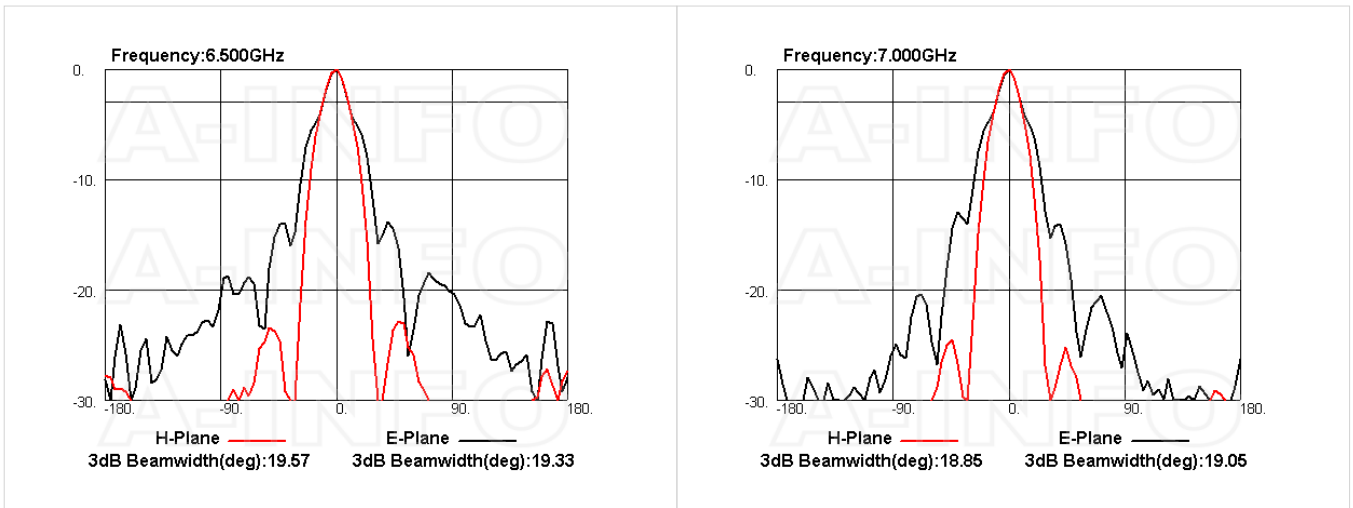

## Related Products



250DRWCAN Right Angle Double Ridge Waveguide to Coaxial Adapter 2.6-7.8GHz WRD250 to N Type Female



250DRWCAS Right Angle Double Ridge Waveguide to Coaxial Adapter 2.6-7.8GHz WRD250 to SMA Female



250DRWECAN Endlaunch Double Ridge Waveguide to Coaxial Adapter 2.6-7.8GHz WRD250 to N Type Female



250DRWECAS Endlaunch Double Ridge Waveguide to Coaxial Adapter 2.6-7.8GHz WRD250 to SMA Female



250DRWHCAN Right Angle High Power Double Ridge Waveguide to Coaxial Adapter 2.6-7.8GHz WRD250 to N Type Female



LB-2678-10-C-MB Round Type Mounting Bracket



LB-2678-10-C-MBL L type mounting bracket



Tripod\_15Kg Al Alloy Tripod



3033HL Wooden Tripod



3033QM Wooden Tripod Metalfree

## Similar Products

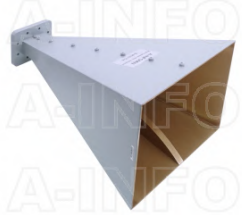

LB-2678-15-A Multi Octave Horn Antenna 2.6-7.8GHz 15dB Gain Double Ridge Waveguide Interface



LB-2678-15-C-NF Multi Octave Horn Antenna 2.6-7.8GHz 15dB Gain N Type Female



LB-2678-15-C-NFSPO Multi Octave Horn Antenna 2.6-7.8GHz 15dB Gain N Type Female



LB-2678-15-C-SF Multi Octave Horn Antenna 2.6-7.8GHz 15dB Gain SMA Female

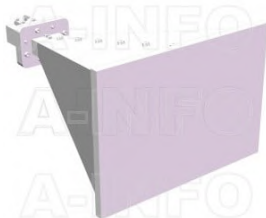

LB-2678-15-C-SFSPO Multi Octave Horn Antenna 2.6-7.8GHz 15dB Gain SMA Female

### About this Datasheet

<ul style="list-style-type: none"> <li>● <b>Product Information</b></li> </ul> <p>Product Link:  <a href="https://www.ainfoinc.com/lb-2678-15-aspo-multi-octave-horn-antenna-2-6-7-8-ghz-15db-gain-fpwr250d30">https://www.ainfoinc.com/lb-2678-15-aspo-multi-octave-horn-antenna-2-6-7-8-ghz-15db-gain-fpwr250d30</a>            Data subject to change without notice.            © A-INFO INC. 2024. All Rights Reserved</p>	<ul style="list-style-type: none"> <li>● <b>Contact Us</b></li> </ul> <p>Address:            60 Tesla, Irvine, CA 92618,            USA</p> <p>Website:  <a href="http://www.ainfoinc.com">www.ainfoinc.com</a></p> <p>Email:  <a href="mailto:sales@ainfoinc.com">sales@ainfoinc.com</a></p>	<ul style="list-style-type: none"> <li>● <b>Phone &amp; Fax</b></li> </ul> <p>Phone:            +1-949-639-9688            +1-949-639-9608</p> <p>Fax:            +1-949-639-9670</p>
---	---	---