

LB-2678-15-A Multi Octave Horn Antenna 2.6-7.8GHz 15dB Gain Double Ridge Waveguide Interface

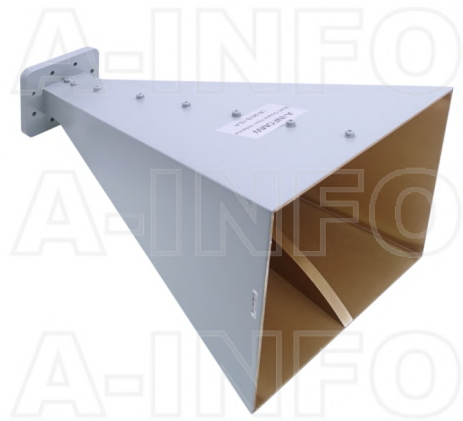

Multi Octave Horn Antenna From 2.6GHz to 7.8GHz With a Nominal 15dB Gain With Double Ridge Waveguide Interface

Product Information

SKU	LB-2678-15-A
-----	--------------

Description

Multi octave horn antenna LB-2678-15-A, operating from 2.6 to 7.8GHz with a nominal 15dB gain and low VSWR 1.5:1 with FPWRD250D30 output. The model LB-2678-15-A has uniform gain through its frequency span, providing efficient performance characteristics and directionality. Constructed of lightweight corrosion-resistant aluminum, the antenna will provide years of trouble-free indoor and outdoor service. This multi octave horn antenna is linearly polarized and ideally suited for EMI testing, direction finding, surveillance, antenna gain and pattern measurements and other applications.

Technical Specification

Electrical Specification		Interface	
Frequency, Min (GHz)	2.6	Output Type	Waveguide
Frequency, Max (GHz)	7.8	Flange Designation, WRD	FPWRD250D30
Waveguide Type	Double Ridge	Connector Gender	N/A
Waveguide Size EIA WRD	WRD250	Mechanical Specification	
Gain, Typ (dBi)	15	Figure	A Type
Polarization	Linear	Body Material	Al
3dB Beamwidth, E-Plane, Min (Deg.)	16	Finish	Chemical Conversion Coating, Gray Paint
3dB Beamwidth, E-Plane, Max (Deg.)	48	Size, W (mm)	228
3dB Beamwidth, H-Plane, Min (Deg.)	16	Size, H (mm)	158
3dB Beamwidth, H-Plane, Max (Deg.)	41	Size, L (mm)	313
Cross Pol. Isolation, Typ (dB)	40	Weight, (kg)	1.2
VSWR, Typ	1.5:1		

Additional Information

Application	General Purpose Indoor & Outdoor, Fixed	Solution for	Gain Reference Antenna Measurement Far-field Measurement System Intergration
-------------	---	--------------	---

Outline Drawing

FPWRD250D30 Output (P/N: LB-2678-15-A)

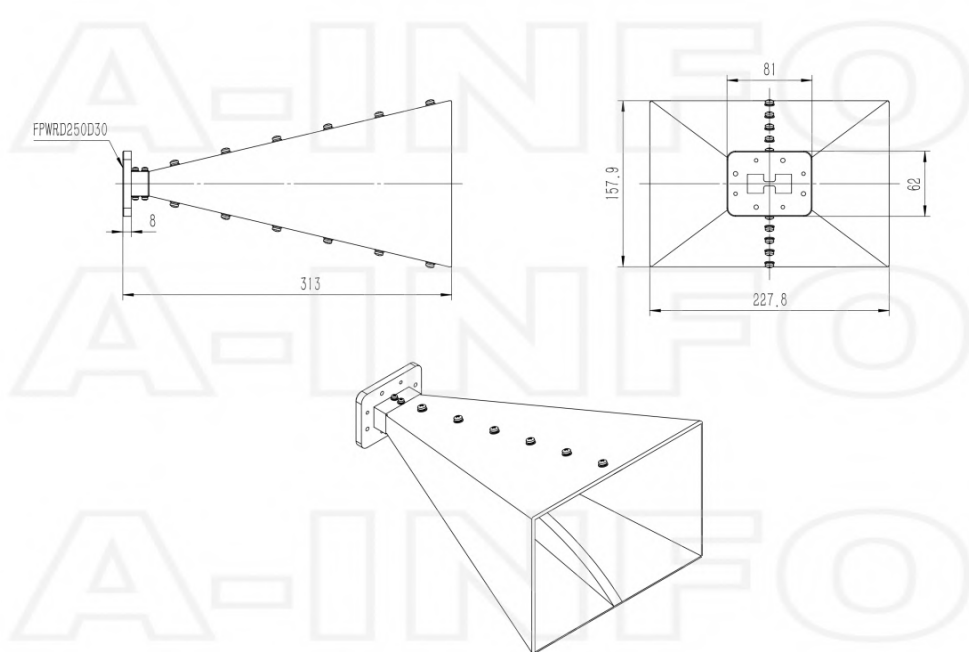

Flange Drawing

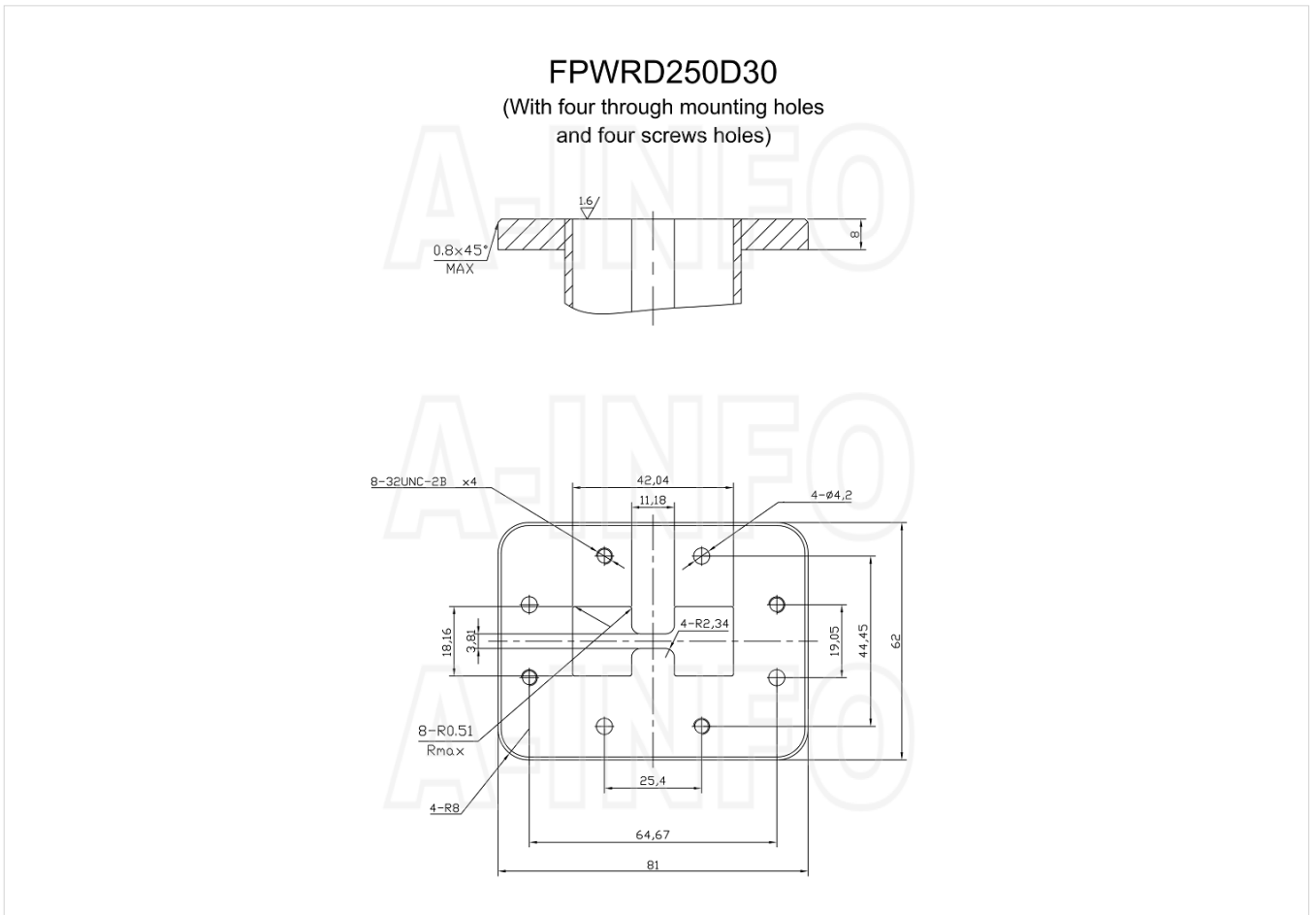

Typical Test Results

Gain

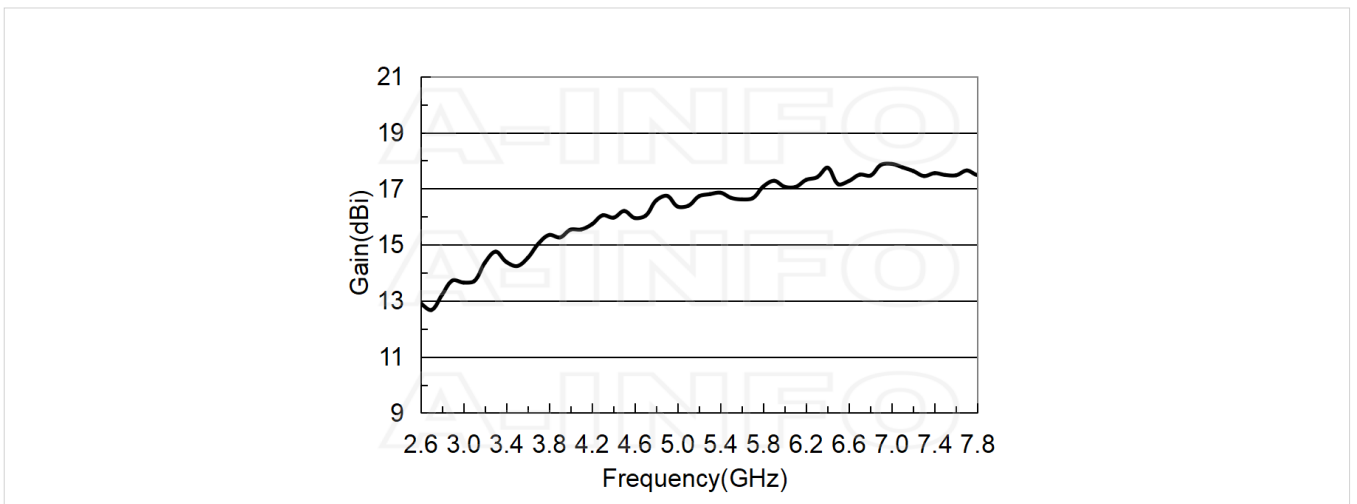

Antenna Factor

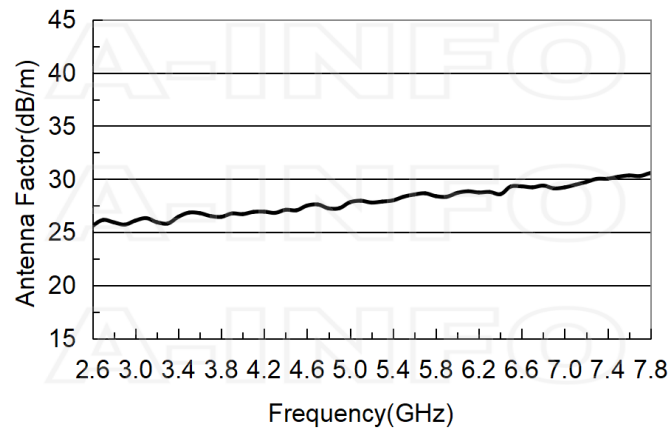

Antenna Factor (Table)

Frequency(GHz)	Gain(dBi)	AF(dB/m)
2.6	12.91	25.60
3.0	13.65	26.10
3.5	14.24	26.85
4.0	15.54	26.71
4.5	16.20	27.07
5.0	16.36	27.83
5.5	16.67	28.35
6.0	17.06	28.71
6.5	17.15	29.31
7.0	17.88	29.23
7.5	17.49	30.22
7.8	17.48	30.57

Cross Polarization Isolation

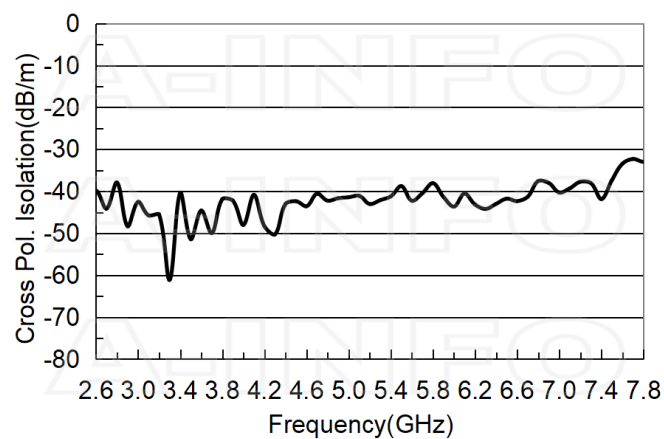

VSWR

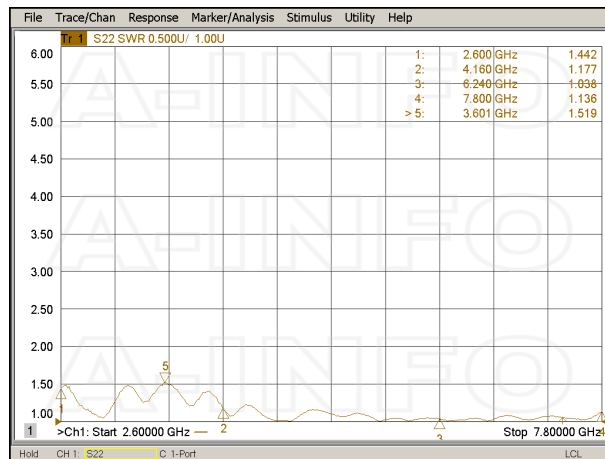

Beamwidth

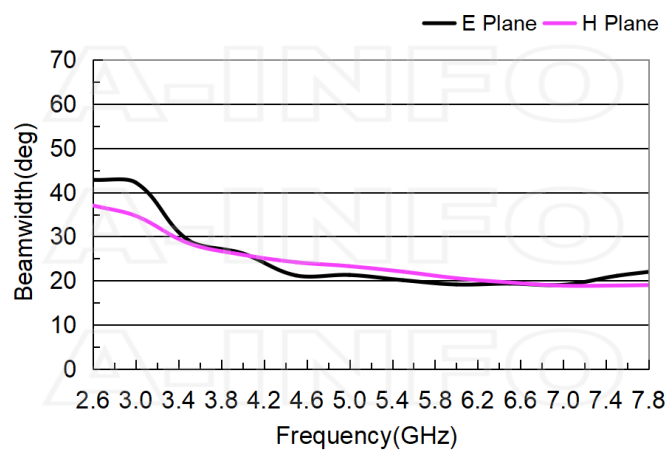

Pattern

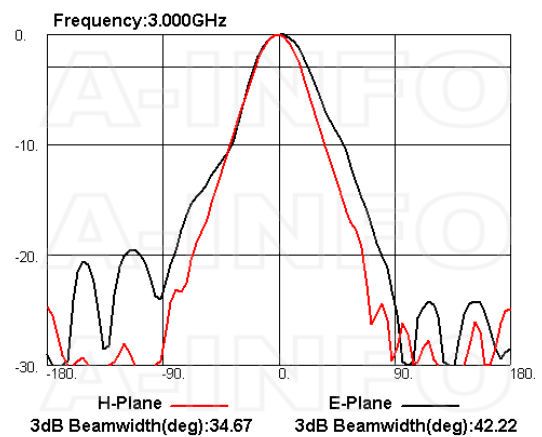
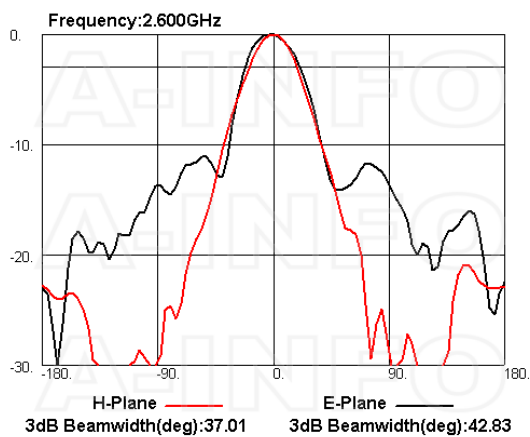

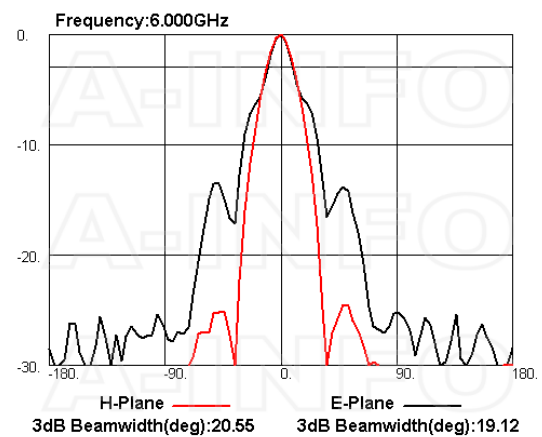
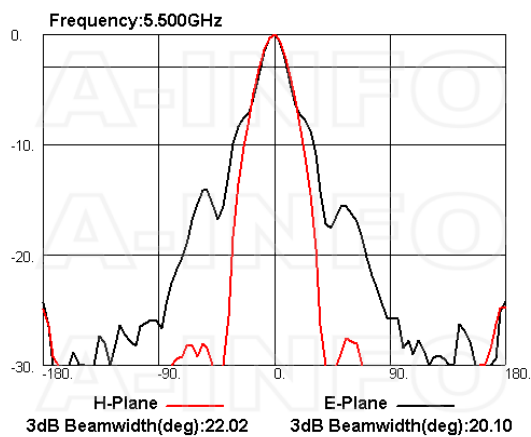
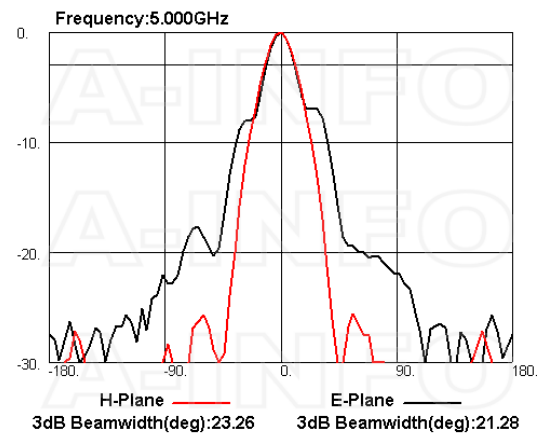
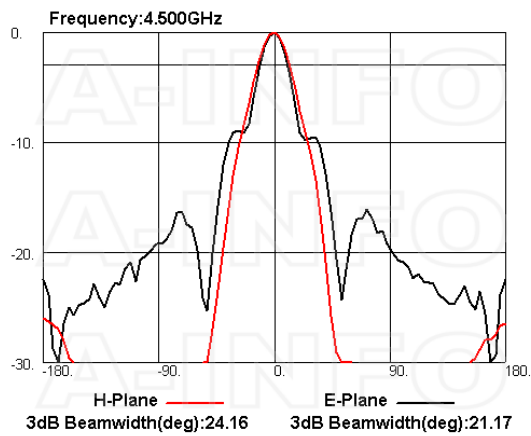
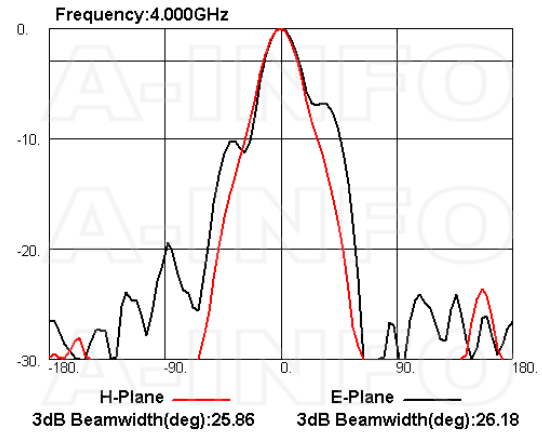
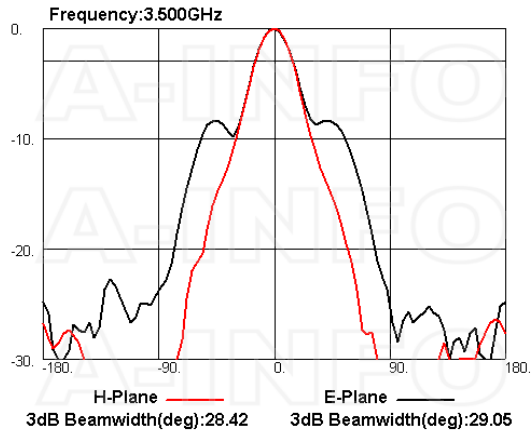

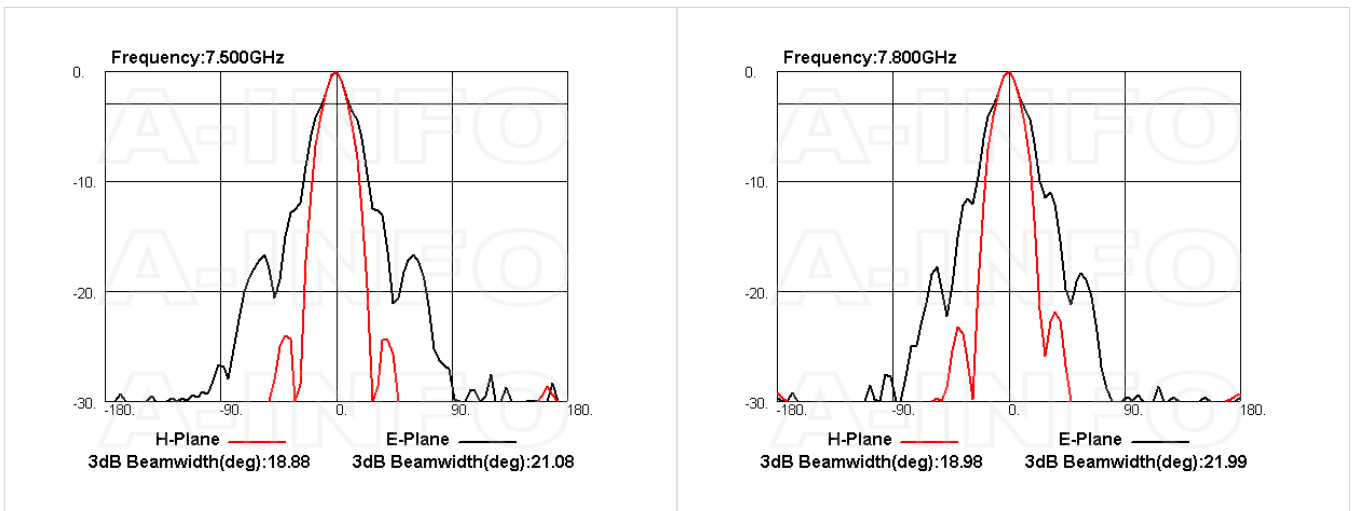
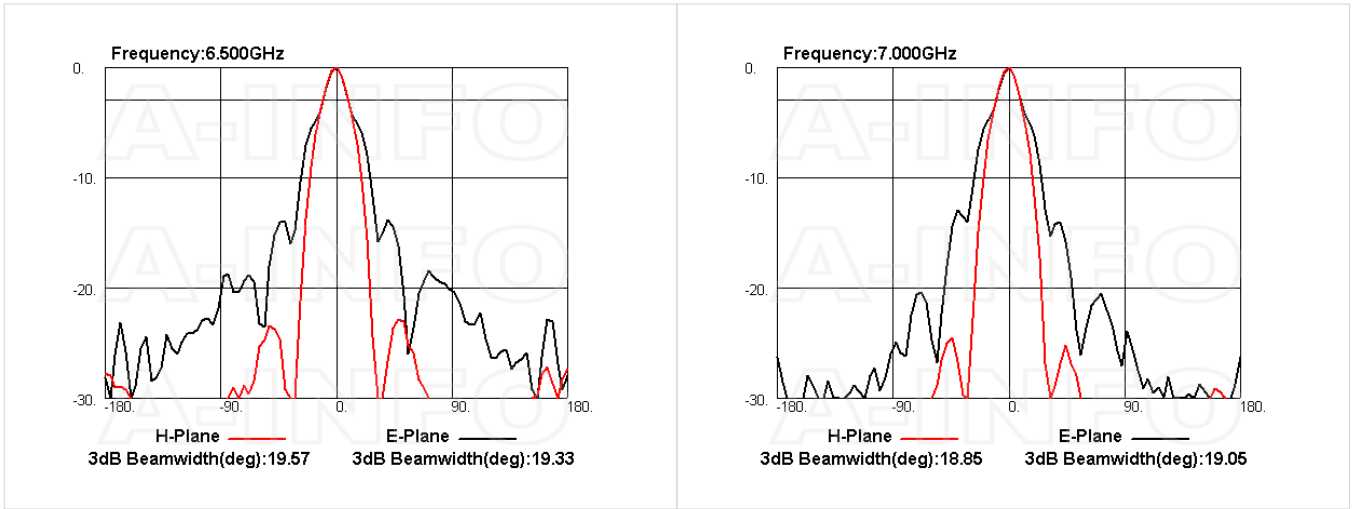

Related Products



250DRWCAN Right Angle Double Ridge Waveguide to Coaxial Adapter 2.6-7.8GHz WRD250 to N Type Female



250DRWCAS Right Angle Double Ridge Waveguide to Coaxial Adapter 2.6-7.8GHz WRD250 to SMA Female



250DRWECAN Endlaunch Double Ridge Waveguide to Coaxial Adapter 2.6-7.8GHz WRD250 to N Type Female



250DRWECAS Endlaunch Double Ridge Waveguide to Coaxial Adapter 2.6-7.8GHz WRD250 to SMA Female



250DRWHCAN Right Angle High Power Double Ridge Waveguide to Coaxial Adapter 2.6-7.8GHz WRD250 to N Type Female



LB-2678-10-C-MB Round Type Mounting Bracket



LB-2678-10-C-MBL L type mounting bracket



Tripod_15Kg Al Alloy Tripod



3033HL Wooden Tripod



3033QM Wooden Tripod Metalfree

Similar Products

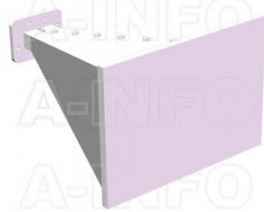

LB-2678-15-ASPO Multi Octave Horn Antenna 2.6-7.8GHz 15dB Gain Double Ridge Waveguide Interface



LB-2678-15-C-NF Multi Octave Horn Antenna 2.6-7.8GHz 15dB Gain N Type Female



LB-2678-15-C-NFSPO Multi Octave Horn Antenna 2.6-7.8GHz 15dB Gain N Type Female

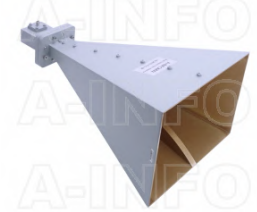

LB-2678-15-C-SF Multi Octave Horn Antenna 2.6-7.8GHz 15dB Gain SMA Female

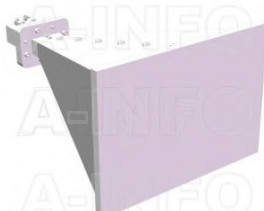

LB-2678-15-C-SFSPO Multi Octave Horn Antenna 2.6-7.8GHz 15dB Gain SMA Female

About this Datasheet

<ul style="list-style-type: none">● Product Information <p>Product Link: https://www.ainfoinc.com/lb-2678-15-a-multi-octave-horn-antenna-2-6-7-8-ghz-15db-gain-fpwr250d30 Data subject to change without notice. © A-INFO INC. 2024. All Rights Reserved</p>	<ul style="list-style-type: none">● Contact Us <p>Address: 60 Tesla, Irvine, CA 92618, USA</p> <p>Website: www.ainfoinc.com</p> <p>Email: sales@ainfoinc.com</p>	<ul style="list-style-type: none">● Phone & Fax <p>Phone: +1-949-639-9688 +1-949-639-9608</p> <p>Fax: +1-949-639-9670</p>
--	---	--