

LB-2048-20-A Multi Octave Horn Antenna 2-4.8GHz 20dB Gain Double Ridge Waveguide Interface

Multi Octave Horn Antenna From 2GHz to 4.8GHz With a Nominal 20dB Gain With Double Ridge Waveguide Interface

Product Information

SKU	LB-2048-20-A
-----	--------------

Description

Multi octave horn antenna LB-2048-20-A, operating from 2 to 4.8GHz with a nominal 20dB gain and low VSWR 1.5:1 with FPWRD200D24 output. The model LB-2048-20-A has uniform gain through its frequency span, providing efficient performance characteristics and directionality. Constructed of lightweight corrosion-resistant aluminum, the antenna will provide years of trouble-free indoor and outdoor service. This multi octave horn antenna is linearly polarized and ideally suited for EMI testing, direction finding, surveillance, antenna gain and pattern measurements and other applications.

Technical Specification

Electrical Specification		Interface	
Frequency, Min (GHz)	2	Output Type	Waveguide
Frequency, Max (GHz)	4.8	Flange Designation, WRD	FPWRD200D24
Waveguide Type	Double Ridge	Mechanical Specification	
Waveguide Size EIA WRD	WRD200	Figure	A Type
Gain, Typ (dBi)	20	Body Material	Al
Polarization	Linear	Finish	Chemical Conversion Coating, Gray Paint
3dB Beamwidth, E-Plane, Min (Deg.)	9	Size, W (mm)	434.1
3dB Beamwidth, E-Plane, Max (Deg.)	21	Size, H (mm)	362.1
3dB Beamwidth, H-Plane, Min (Deg.)	10	Size, L (mm)	753
3dB Beamwidth, H-Plane, Max (Deg.)	23	Weight, (kg)	5.55
Cross Pol. Isolation, Typ (dB)	45		
VSWR, Typ	1.5:1		

Additional Information

Application	General Purpose Indoor & Outdoor, Fixed	Solution for	Gain Reference Antenna Measurement Far-field Measurement System Intergration
-------------	---	--------------	---

Outline Drawing

FPWRD200D24 Output (P/N: LB-2048-20-A)

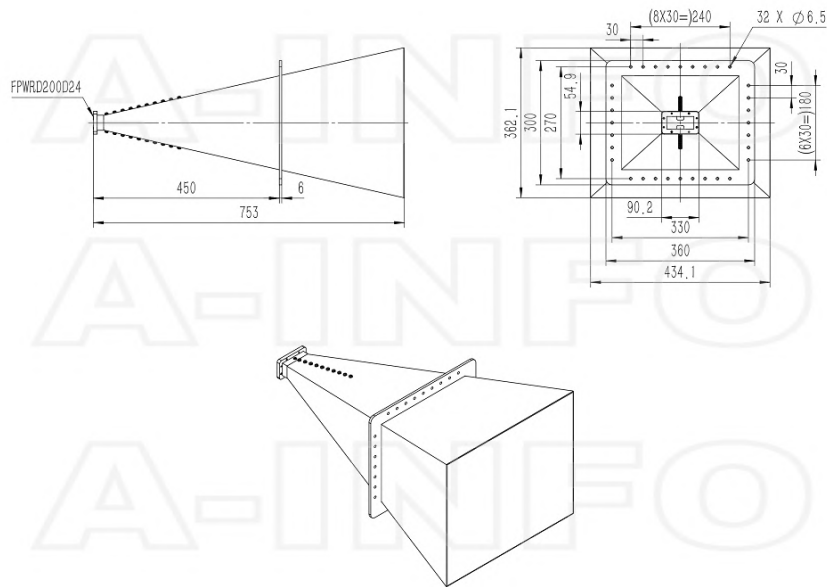

Flange Drawing

FPWRD200D24

(With four through mounting holes and four screws holes)

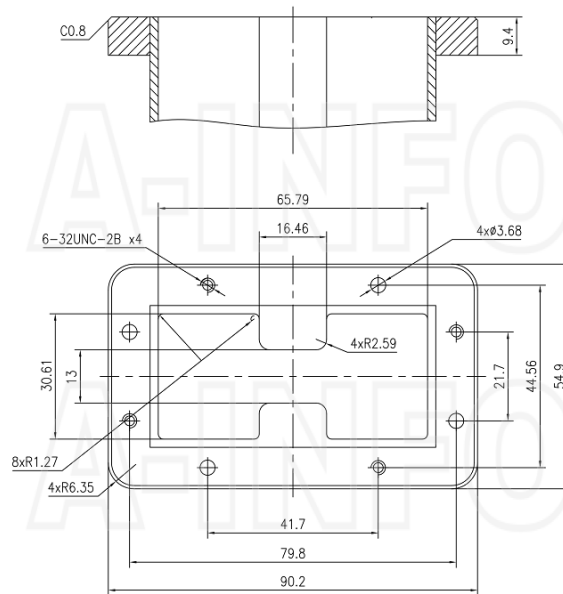

Typical Test Results

Gain

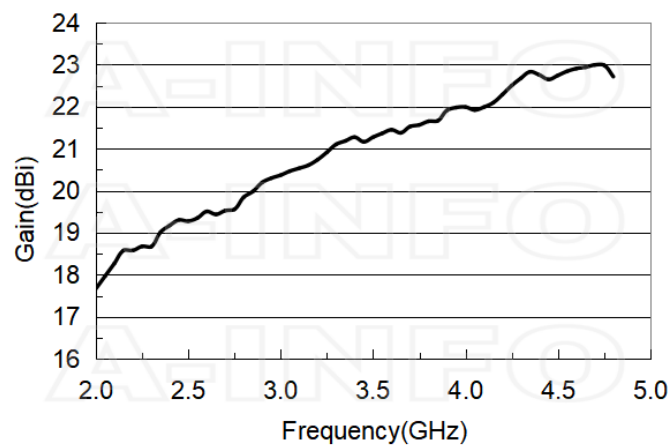

Antenna Factor

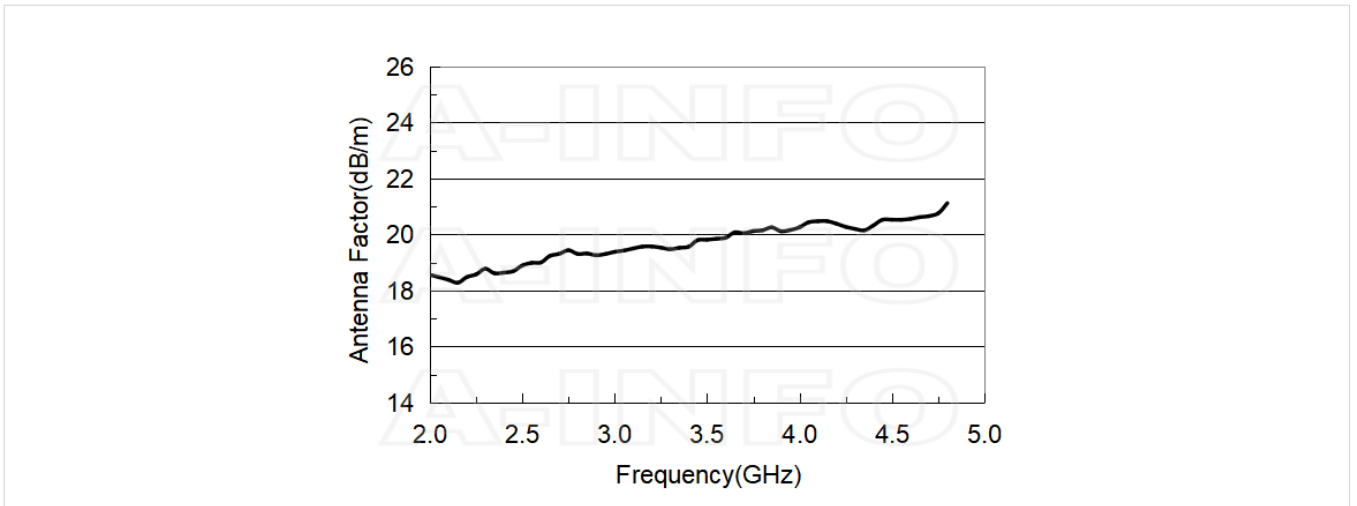

Antenna Factor (Table)

Frequency(GHz)	Gain(dBi)	AF(dB/m)
2.0	17.67	18.56
2.2	18.58	18.48
2.4	19.17	18.64
2.6	19.51	19.00
2.8	19.84	19.31
3.0	20.37	19.38
3.2	20.74	19.58
3.4	21.27	19.57
3.6	21.45	19.89
3.8	21.65	20.16
4.0	21.99	20.26
4.2	22.29	20.39
4.4	22.75	20.33
4.6	22.91	20.56
4.8	22.71	21.12

Cross Polarization Isolation

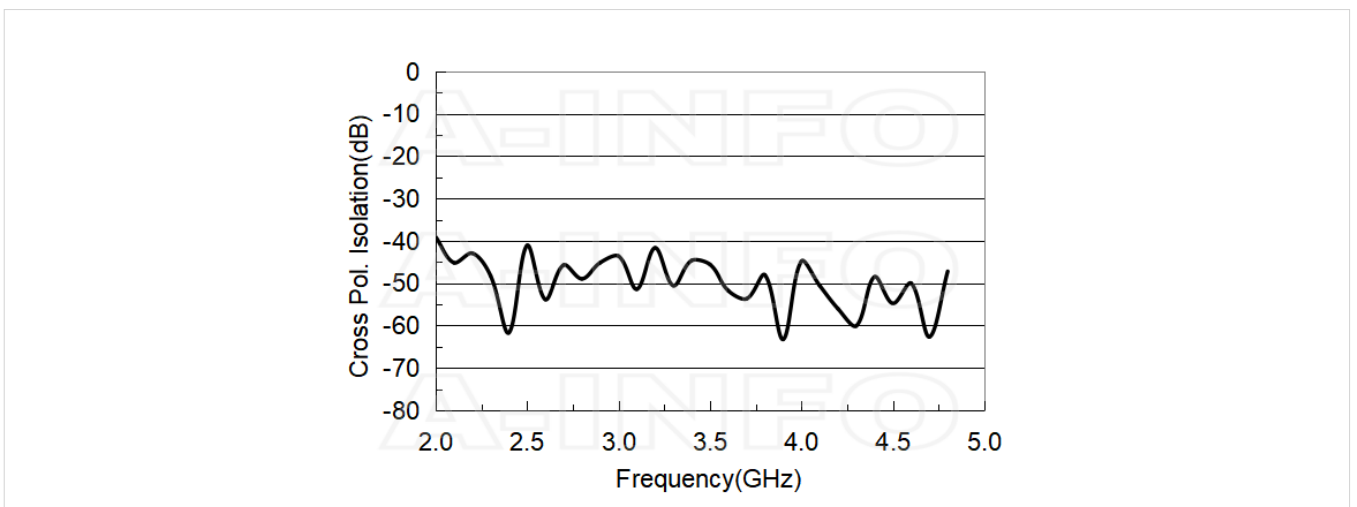

VSWR

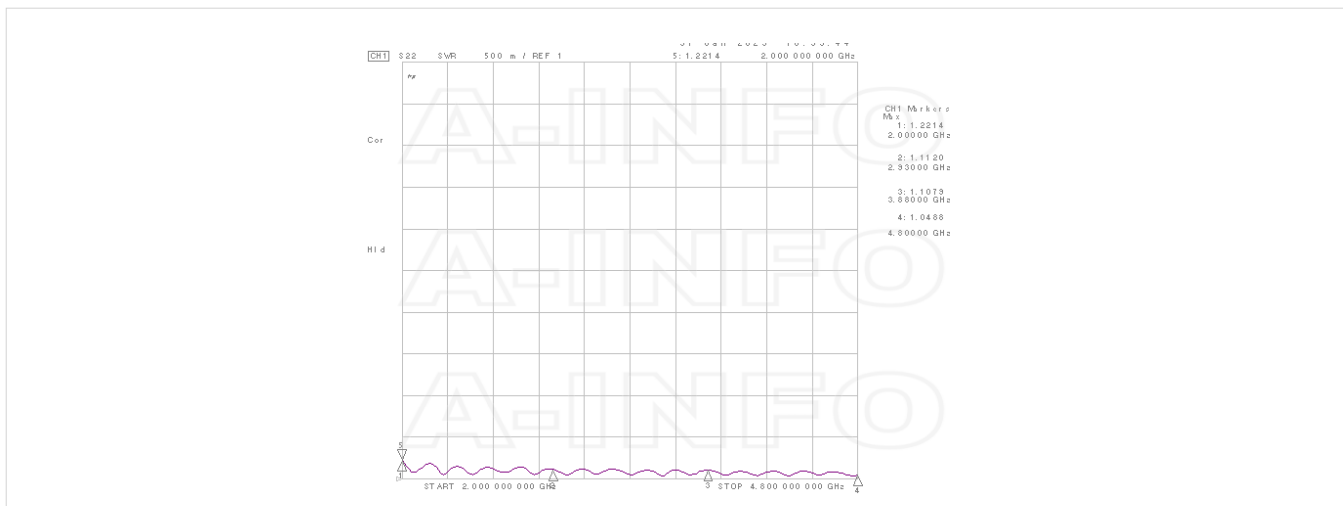

Beamwidth

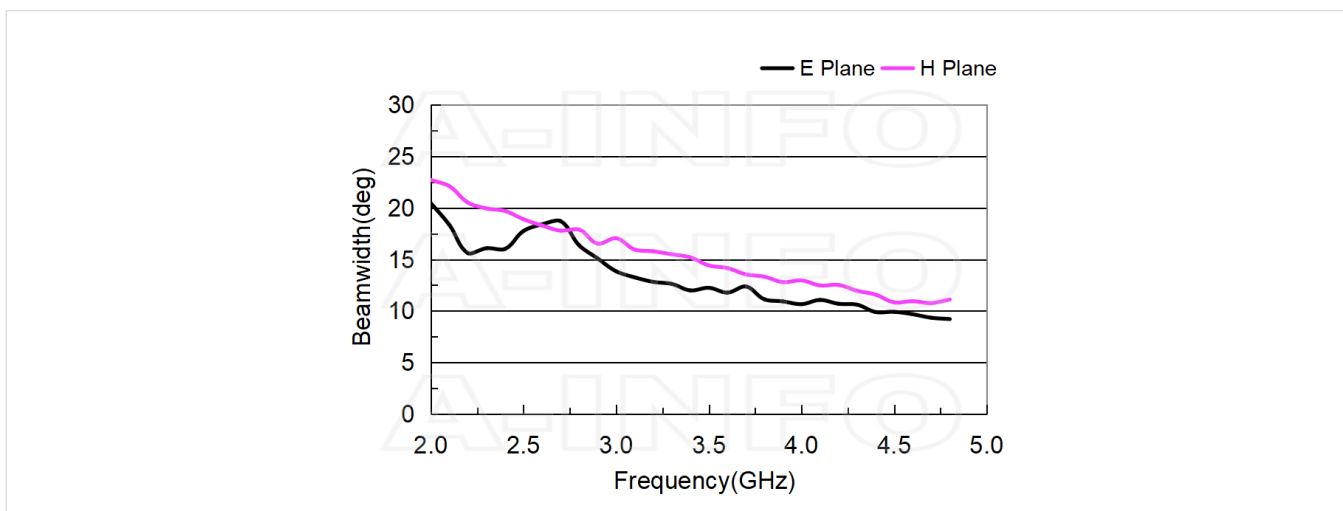

Pattern

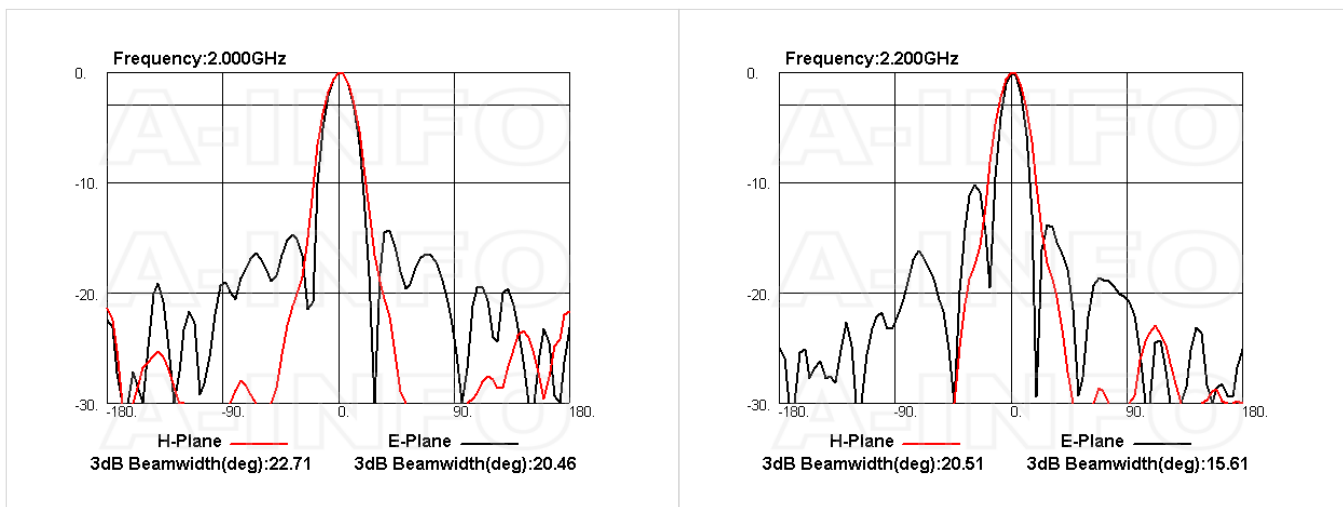

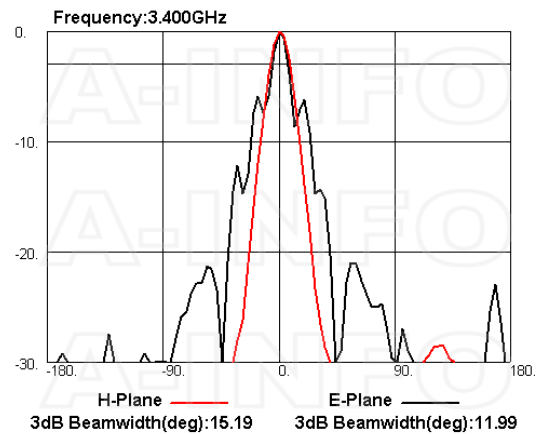
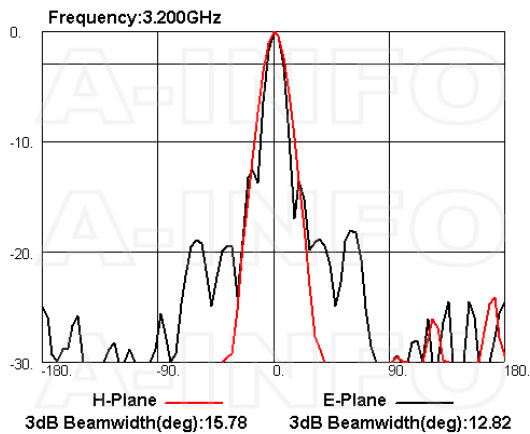
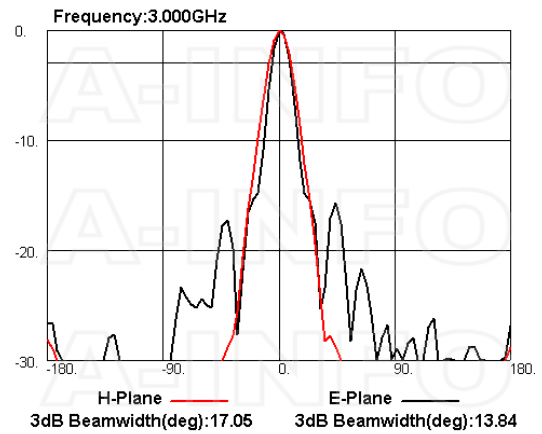
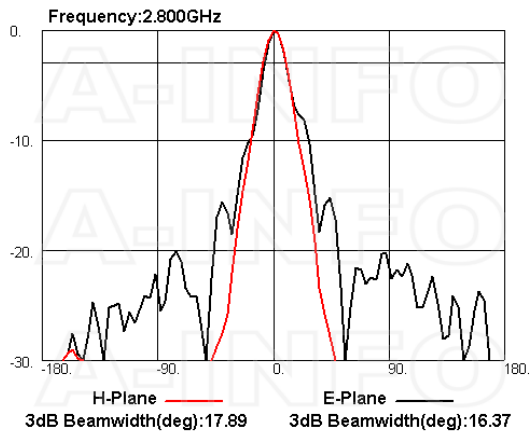
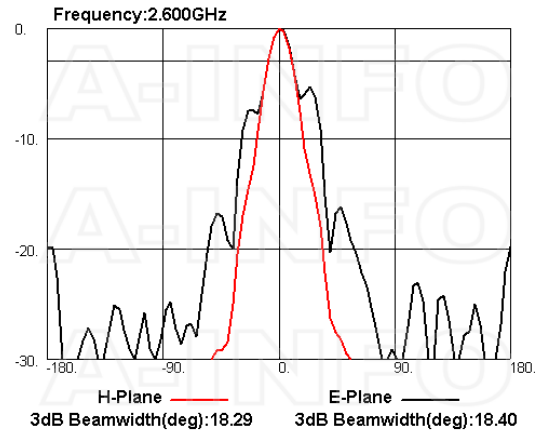
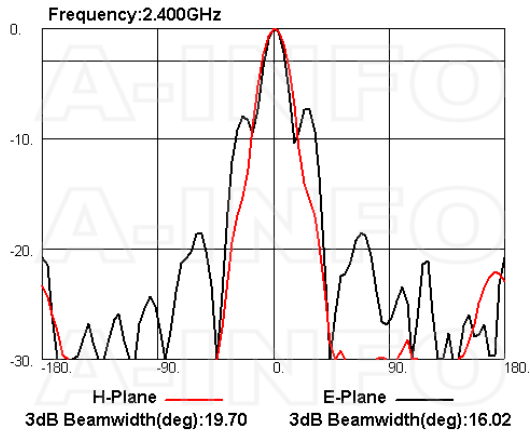

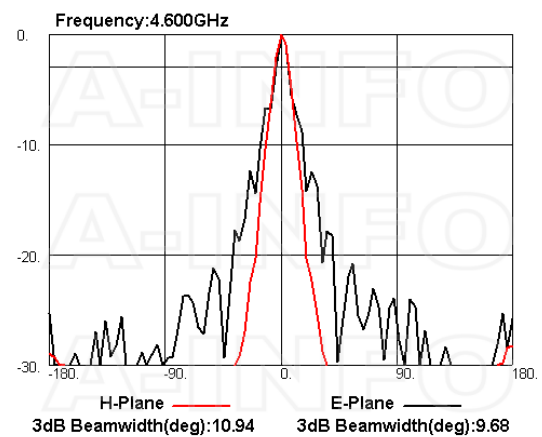
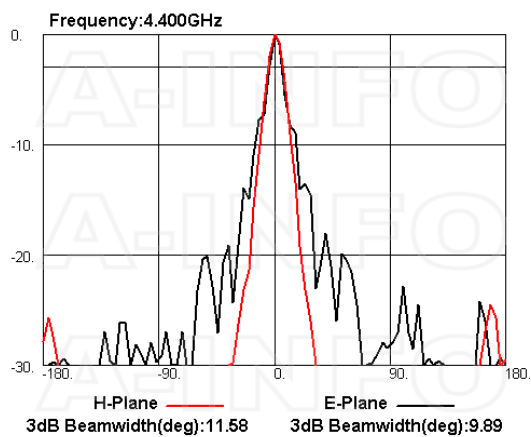
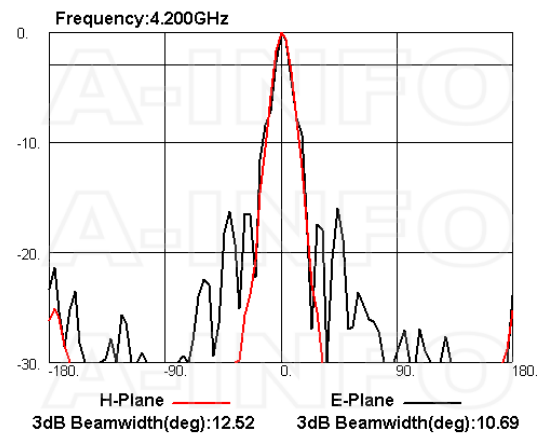
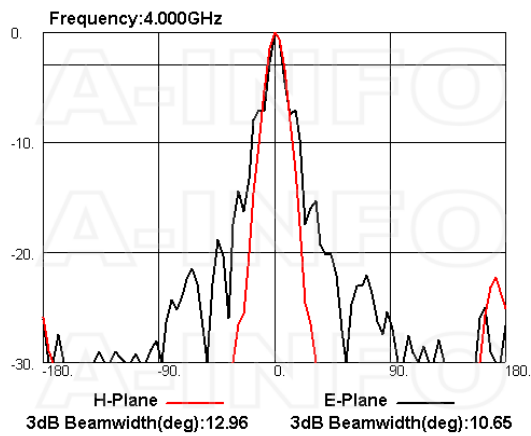
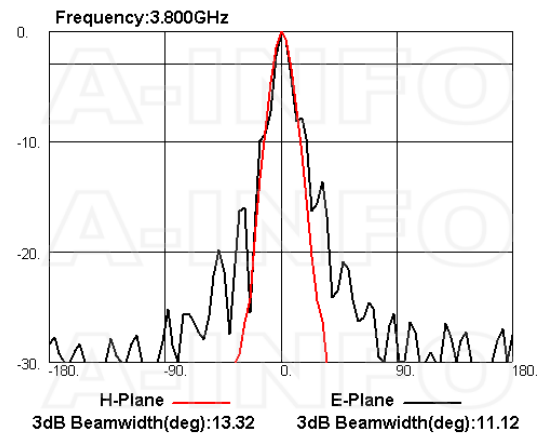
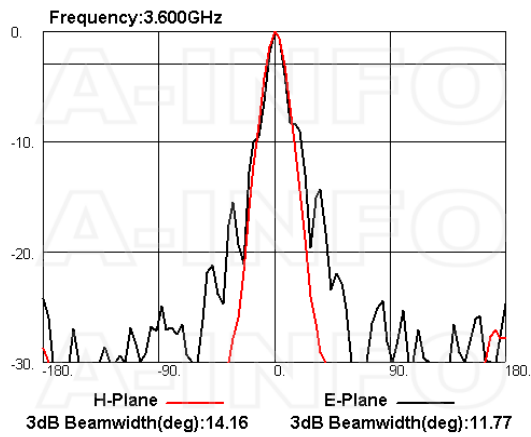

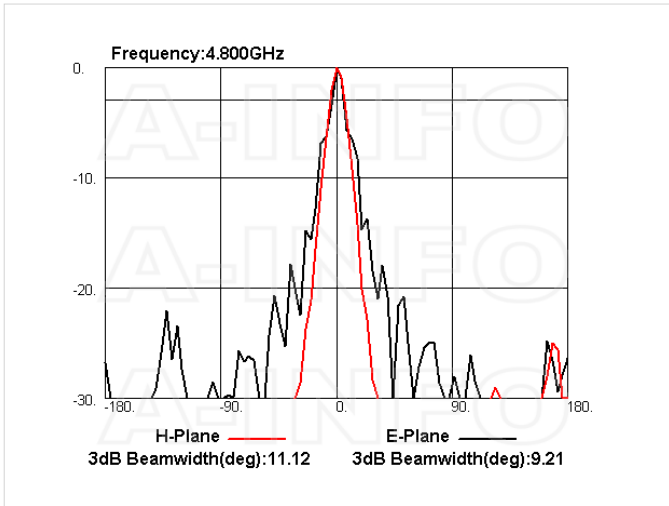

Related Products



LB-2048-20-C-MB Round Type Mounting Bracket



LB-2048-20-C-L L type mounting bracket



Tripod_15Kg Al Alloy Tripod



3033HL Wooden Tripod



3033QM Wooden Tripod Metalfree



200DRWCAN Right Angle Double Ridge Waveguide to Coaxial Adapter 2-4.8GHz WRD200 to N Type Female



200DRWCAS Right Angle Double Ridge Waveguide to Coaxial Adapter 2-4.8GHz WRD200 to SMA Female



200DRWECAN Endlaunch Double Ridge Waveguide to Coaxial Adapter 2-4.8GHz WRD200 to N Type Female



200DRWECAS Endlaunch Double Ridge Waveguide to Coaxial Adapter 2-4.8GHz WRD200 to SMA Female



200DRWHCAN Right Angle High Power Double Ridge Waveguide to Coaxial Adapter 2-4.8GHz WRD200 to N Type Female

Similar Products



LB-2048-20-C-NF Multi Octave
Horn Antenna 2-4.8GHz 20dB
Gain N Type Female

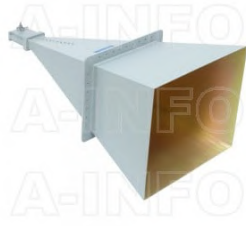

LB-2048-20-C-SF Multi Octave
Horn Antenna 2-4.8GHz 20dB
Gain SMA Female

About this Datasheet

<ul style="list-style-type: none"> ● Product Information Product Link: https://www.ainfoinc.com/lb-2048-20-a-multi-octave-horn-antenna-2-4-8-ghz-20db-gain-fpwr200d24 Data subject to change without notice. © A-INFO INC. 2024. All Rights Reserved 	<ul style="list-style-type: none"> ● Contact Us Address: 60 Tesla, Irvine, CA 92618, USA Website: www.ainfoinc.com Email: sales@ainfoinc.com 	<ul style="list-style-type: none"> ● Phone & Fax Phone: +1-949-639-9688 +1-949-639-9608 Fax: +1-949-639-9670
---	--	---