

LB-2048-15-ASPO Multi Octave Horn Antenna 2-4.8GHz 15dB Gain Double Ridge Waveguide Interface

Multi Octave Horn Antenna From 2GHz to 4.8GHz With a Nominal 15dB Gain With Double Ridge Waveguide Interface

Product Information

SKU	LB-2048-15-ASPO
-----	-----------------

Description

Multi octave horn antenna LB-2048-15-ASPO, operating from 1.5 to 3.6GHz with a nominal 15dB gain and low VSWR 1.5:1 with FPWRD200D24 output. The model LB-2048-15-ASPO has uniform gain through its frequency span, providing efficient performance characteristics and directionality. Constructed of lightweight corrosion-resistant aluminum, the horn comes with a specially designed weatherproof radome which provides excellent protection against the rain and dust but has very little loss across the full operating frequency band. This multi octave horn antenna is linearly polarized and ideally suited for EMI testing, direction finding, surveillance, antenna gain and pattern measurements and other applications.

Technical Specification

Electrical Specification		Interface	
Frequency, Min (GHz)	2	Output Type	Waveguide
Frequency, Max (GHz)	4.8	Flange Designation, WRD	FPWRD200D24
Waveguide Type	Double Ridge	Connector Gender	N/A
Waveguide Size EIA WRD	WRD200	Mechanical Specification	
Gain, Typ (dBi)	15	Figure	A Type
Polarization	Linear	Body Material	Al
3dB Beamwidth, E-Plane, Min (Deg.)	17	Finish	Chemical Conversion Coating, Gray Paint
3dB Beamwidth, E-Plane, Max (Deg.)	44	Size, W (mm)	257
3dB Beamwidth, H-Plane, Min (Deg.)	19	Size, H (mm)	207
3dB Beamwidth, H-Plane, Max (Deg.)	47	Size, L (mm)	316
Cross Pol. Isolation, Typ (dB)	40	Weight, (kg)	2.1
VSWR, Typ	1.5:1		

Additional Information

Application	Outdoor, Waterproof and Dustproof, Fixed	Solution for	Gain Reference Antenna Measurement Far-field Measurement System Intergration
-------------	--	--------------	---

Outline Drawing

FPWRD200D24 Output with Radome (Option, P/N: LB-2048-15-ASPO, Outdoor Application)

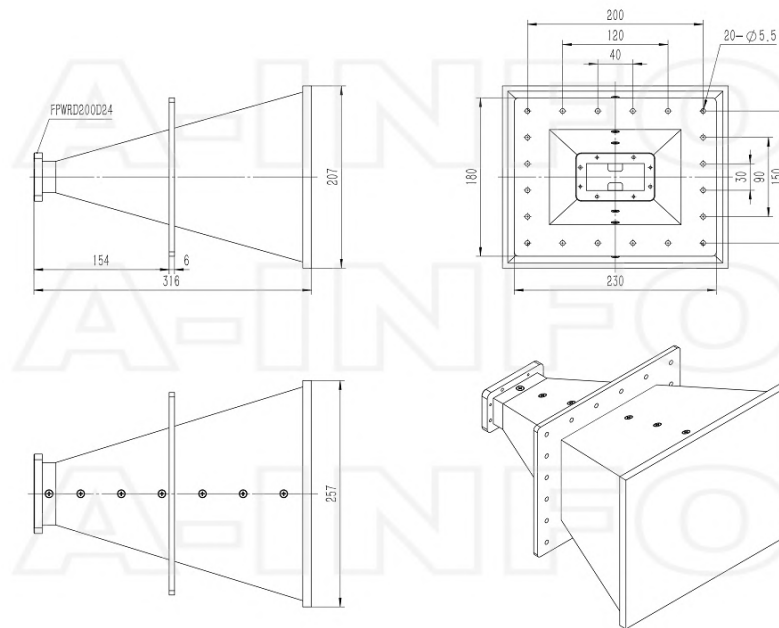

Flange Drawing

FPWRD200D24

(With four through mounting holes and four screws holes)

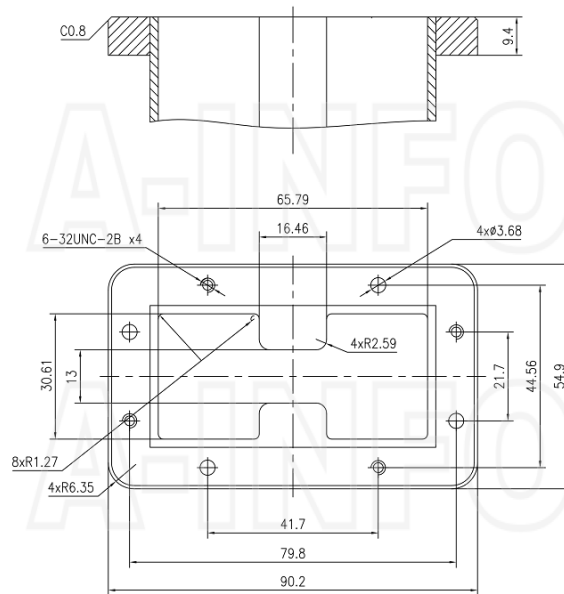

Typical Test Results

Gain

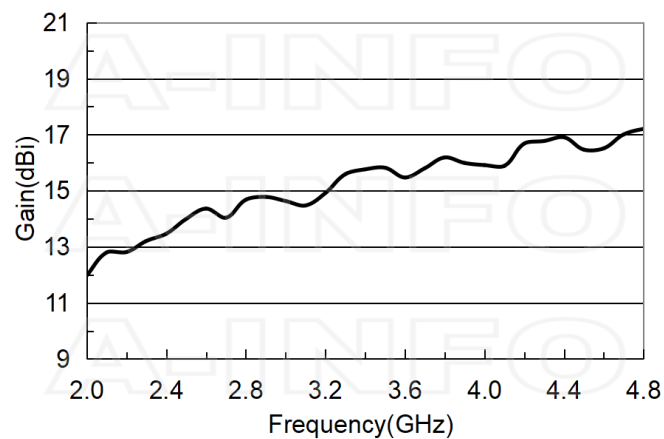

Antenna Factor

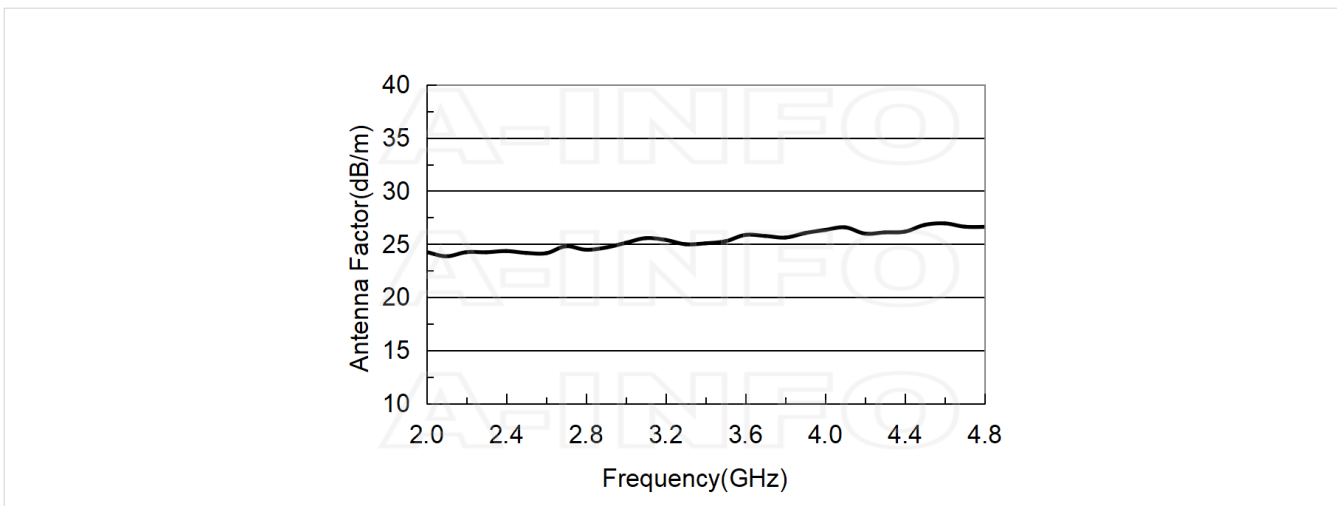

Antenna Factor (Table)

Frequency(GHz)	Gain(dBi)	AF(dB/m)
2.0	11.97	24.26
2.2	12.81	24.25
2.4	13.47	24.35
2.6	14.36	24.15
2.8	14.68	24.48
3.0	14.63	25.12
3.2	14.92	25.40
3.4	15.76	25.08
3.6	15.47	25.86
3.8	16.19	25.62
4.0	15.91	26.34
4.2	16.68	25.99
4.4	16.91	26.17
4.6	16.51	26.95
4.8	17.21	26.63

Cross Polarization Isolation

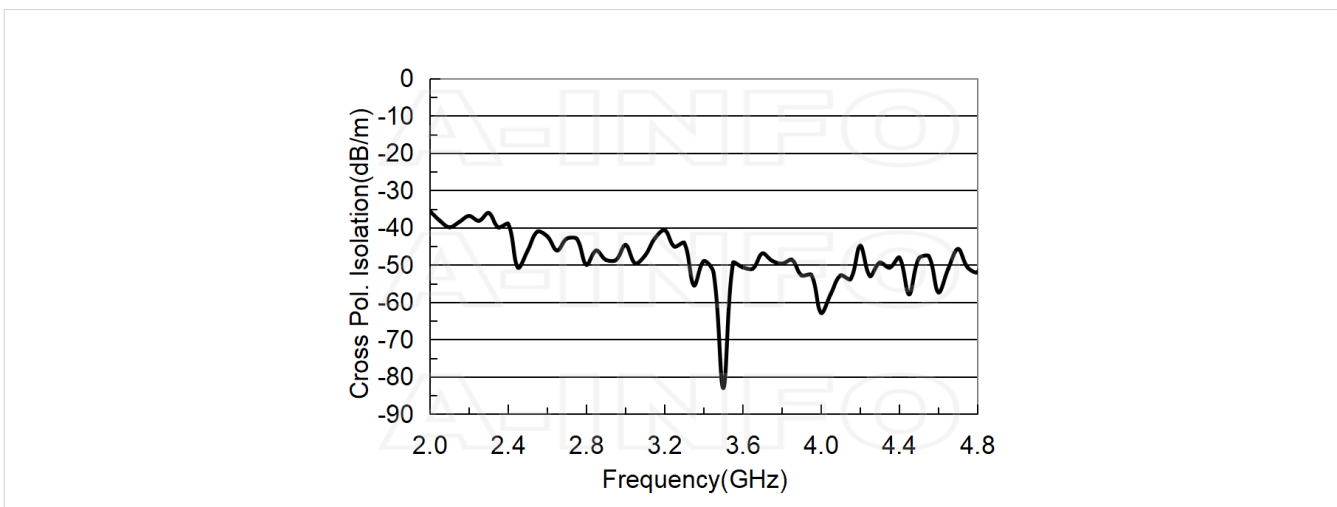

VSWR

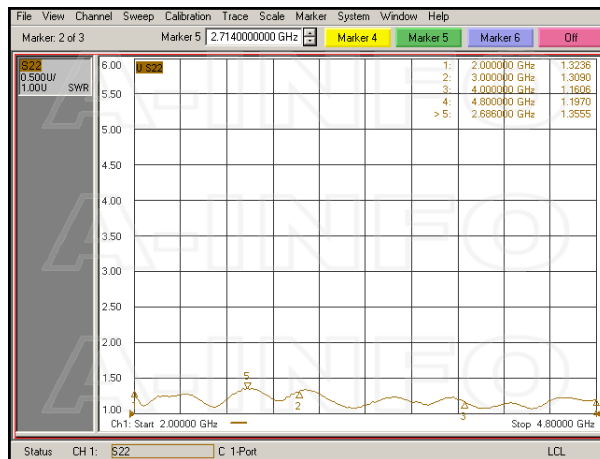

Beamwidth

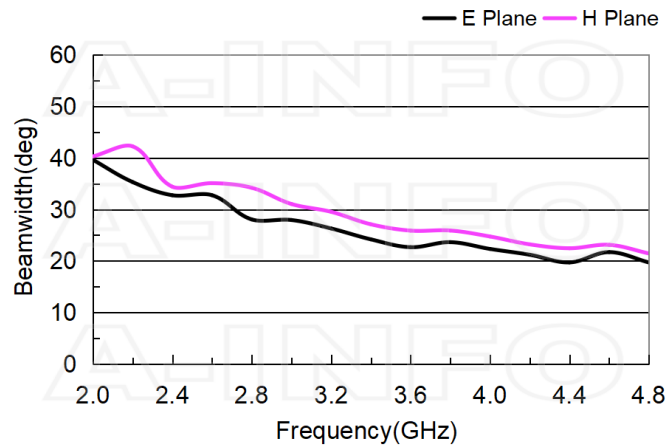

Pattern

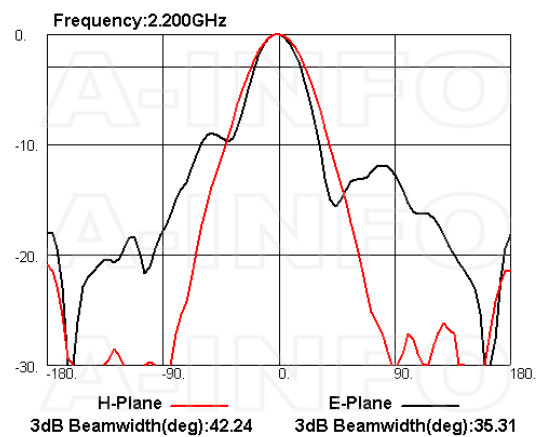
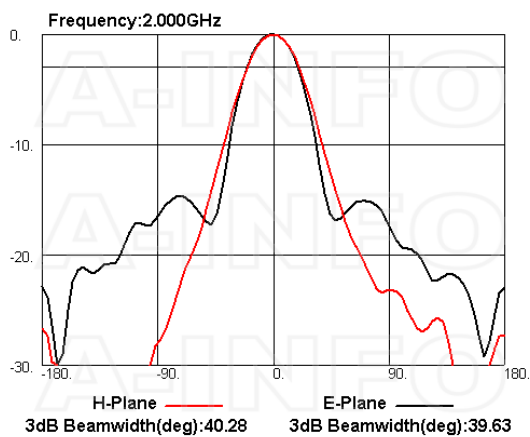

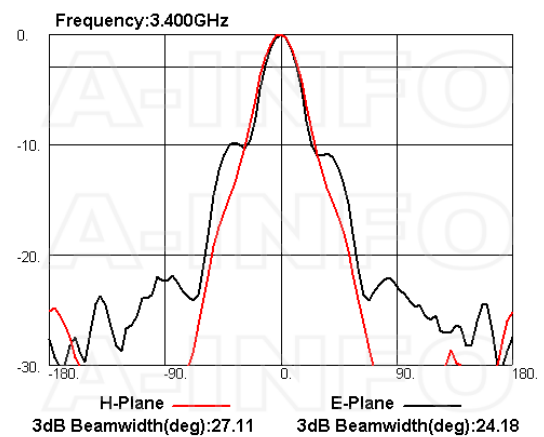
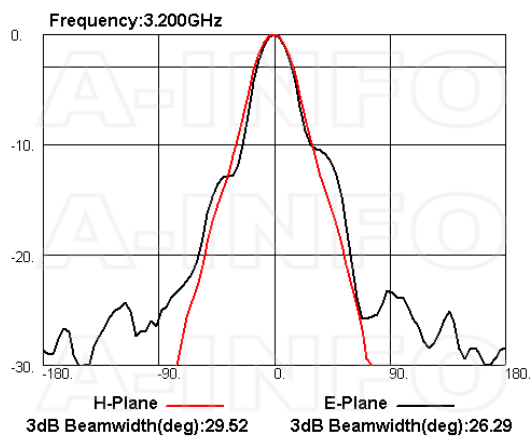
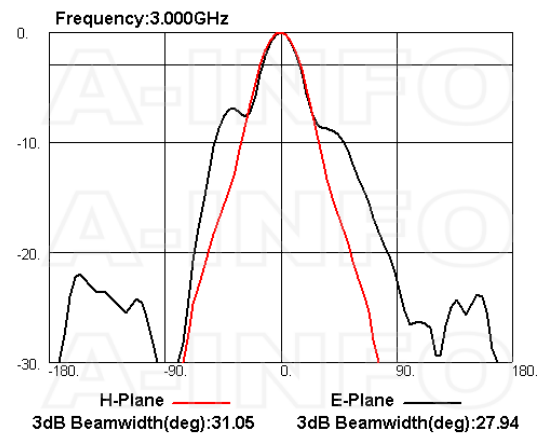
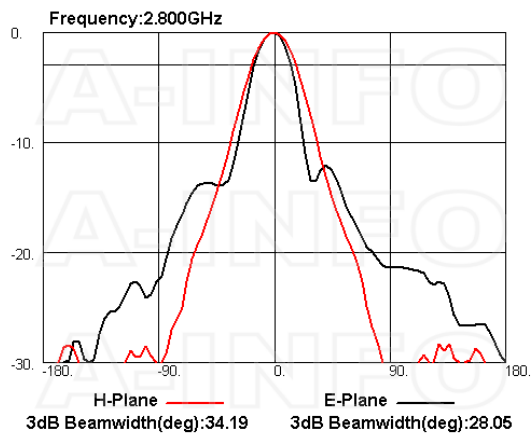
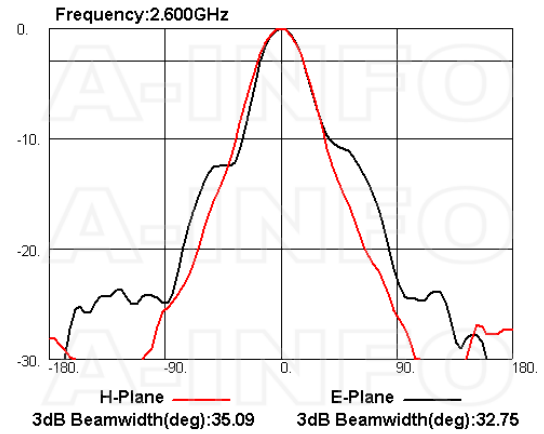
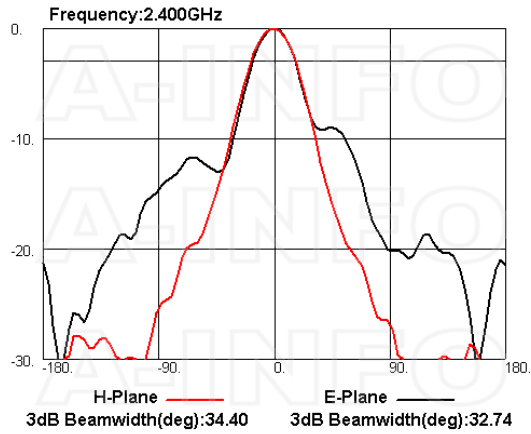

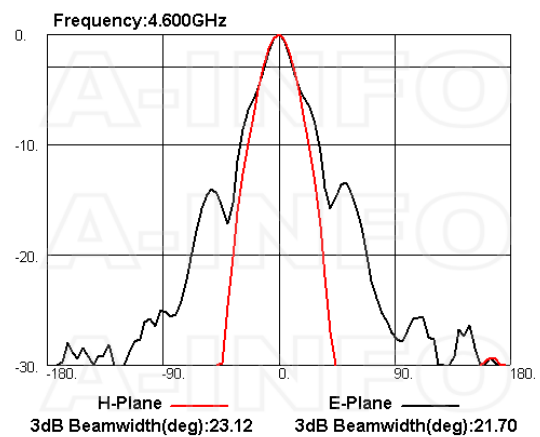
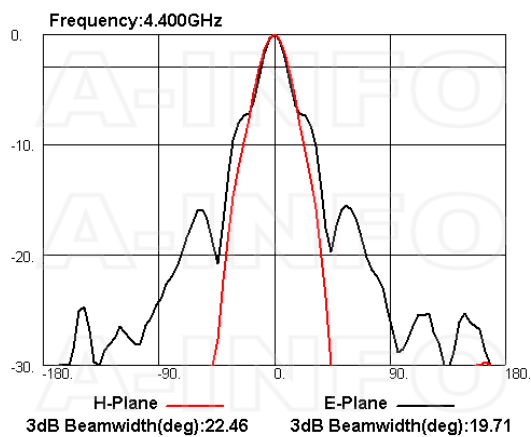
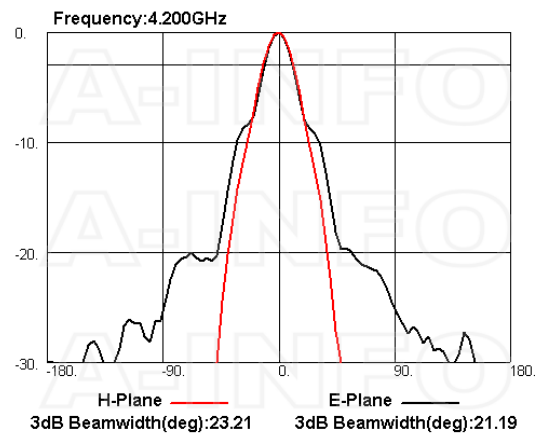
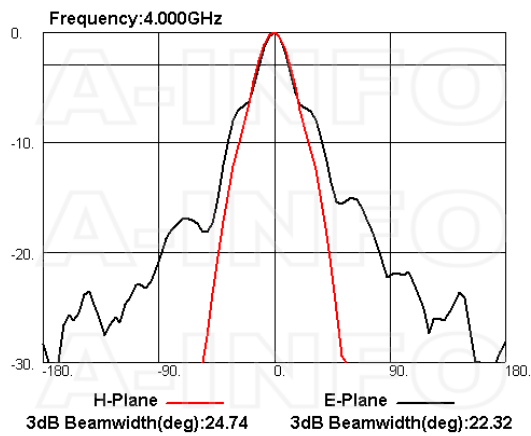
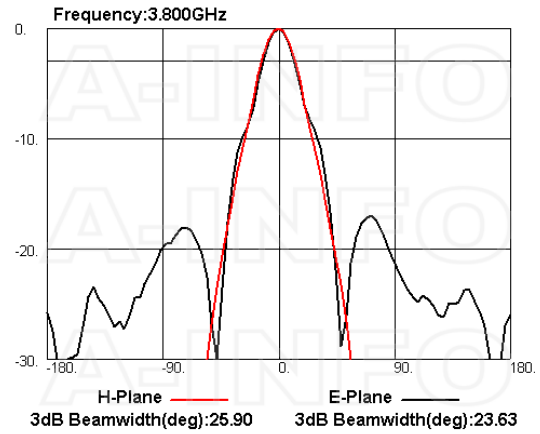
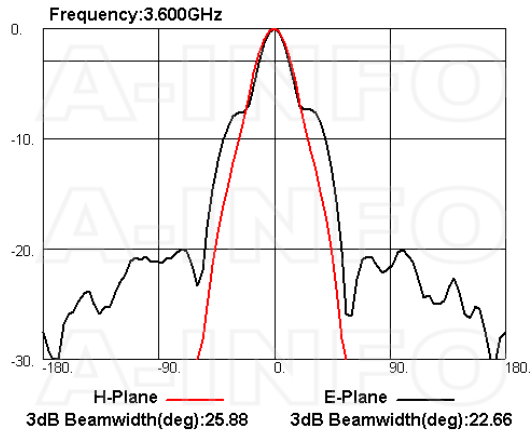

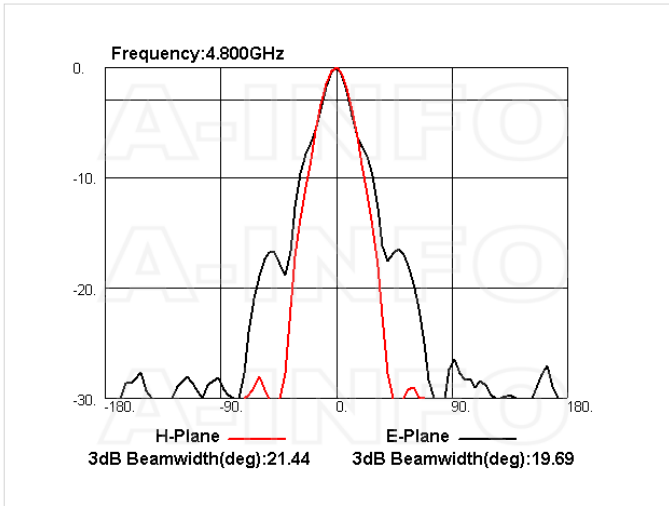

Related Products



200DRWCAN Right Angle Double Ridge Waveguide to Coaxial Adapter 2-4.8GHz WRD200 to N Type Female



200DRWCAS Right Angle Double Ridge Waveguide to Coaxial Adapter 2-4.8GHz WRD200 to SMA Female



200DRWECAN Endlaunch Double Ridge Waveguide to Coaxial Adapter 2-4.8GHz WRD200 to N Type Female



200DRWECAS Endlaunch Double Ridge Waveguide to Coaxial Adapter 2-4.8GHz WRD200 to SMA Female



200DRWHCAN Right Angle High Power Double Ridge Waveguide to Coaxial Adapter 2-4.8GHz WRD200 to N Type Female



LB-2048-15-C-L L type mounting bracket



Carrying Case_LB-2048-15-C Al Alloy Carrying Case

Similar Products

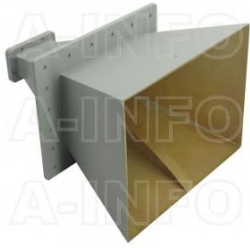

LB-2048-15-A Multi Octave Horn Antenna 2-4.8GHz 15dB Gain Double Ridge Waveguide Interface



LB-2048-15-C-NF Multi Octave Horn Antenna 2-4.8GHz 15dB Gain N Type Female



LB-2048-15-C-NFSPO Multi Octave Horn Antenna 2-4.8GHz 15dB Gain N Type Female

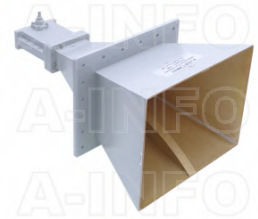

LB-2048-15-C-SF Multi Octave Horn Antenna 2-4.8GHz 15dB Gain SMA Female

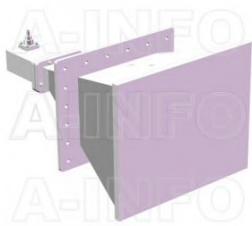

LB-2048-15-C-SFSPO Multi Octave Horn Antenna 2-4.8GHz 15dB Gain SMA Female

About this Datasheet

<p>● Product Information Product Link: https://www.ainfoinc.com/lb-2048-15-aspo-multi-octave-horn-antenna-2-4-8-ghz-15db-gain-fpwr200d24 Data subject to change without notice. © A-INFO INC. 2024. All Rights Reserved</p>	<p>● Contact Us Address: 60 Tesla, Irvine, CA 92618, USA Website: www.ainfoinc.com Email: sales@ainfoinc.com</p>	<p>● Phone & Fax Phone: +1-949-639-9688 +1-949-639-9608 Fax: +1-949-639-9670</p>
--	---	---