



LB-180550-10-C-1.85F Multi Octave Horn Antenna 18-55GHz 10dB Gain
1.85mm Female

Multi Octave Horn Antenna Operating From 18GHz to 55GHz With a
Nominal 10dB Gain With 1.85mm Female Connector

Product Information

SKU	LB-180550-10-C-1.85F
-----	----------------------

Description

Multi octave horn antenna LB-180550-10-C-1.85F, operating from 18 to 55GHz with a nominal 10dB gain and low VSWR 1.5:1 with 1.85mm Female output connector. The model LB-180550-10-C-1.85F has uniform gain through its frequency span, providing efficient performance characteristics and directionality. It can handle 5W continuously and 10W peak power. Constructed of high thermal and electrical conductivity durable copper, the antenna will provide years of trouble-free indoor and outdoor service. This multi octave horn antenna is linearly polarized and ideally suited for EMI testing, direction finding, surveillance, antenna gain and pattern measurements and other applications.

Technical Specification

Electrical Specification		Interface	
Frequency, Min (GHz)	18	Output Type	Coaxial
Frequency, Max (GHz)	55	Connector	1.85mm(V)
Waveguide Type	Double Ridge	Connector Gender	Female
Waveguide Size EIA WRD	WRD180	Mechanical Specification	
Gain, Typ (dBi)	10	Figure	C Type
Polarization	Linear	Body Material	Cu
3dB Beamwidth, E-Plane, Min (Deg.)	24	Finish	Gold Plated, Gray Paint
3dB Beamwidth, E-Plane, Max (Deg.)	58	Size, W (mm)	22.4
3dB Beamwidth, H-Plane, Min (Deg.)	21	Size, H (mm)	28.1
3dB Beamwidth, H-Plane, Max (Deg.)	60	Size, L (mm)	55.8
Cross Pol. Isolation, Typ (dB)	40	Weight, (kg)	0.08
VSWR, Typ	1.5:1		
Impedance, (Ohm)	50		
Power Handling, CW, (W)	5		
Power Handling, Peak, (W)	10		

Additional Information

Application	General Purpose Indoor & Outdoor, Fixed	Solution for	Gain Reference Antenna Measurement Far-field Measurement System Intergration
-------------	---	--------------	---

Outline Drawing

1.85mm-Female Output (P/N: LB-180550-10-C-1.85F)

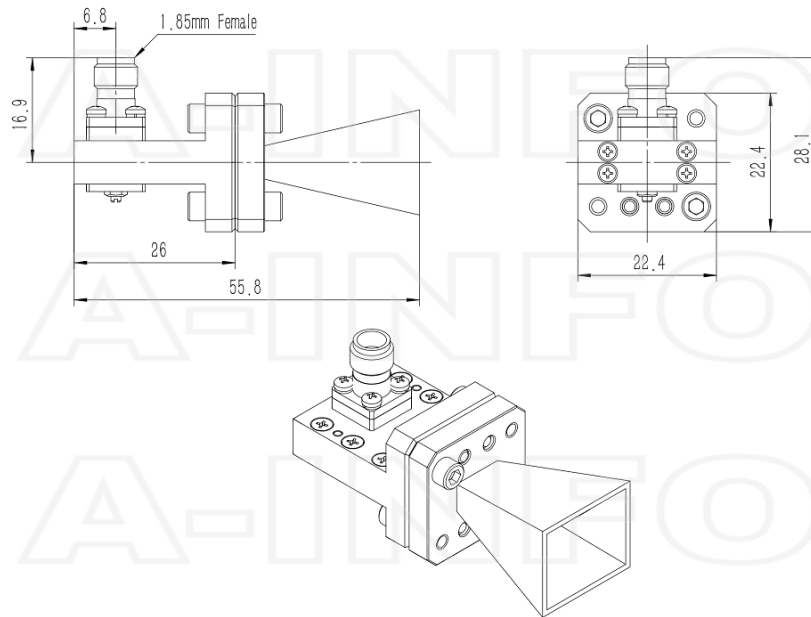

1.85mm-Female Output with Round Mounting Bracket (Option, P/N: LB-180400-10-C-MB)

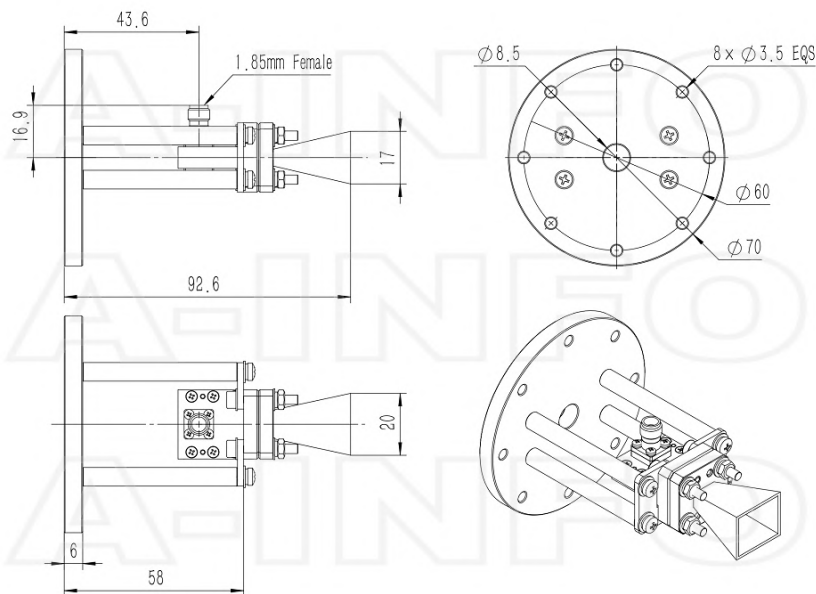

1.85mm-Female Output with L Type Mounting Bracket (Option, P/N: LB-180400-10-C-MBL)

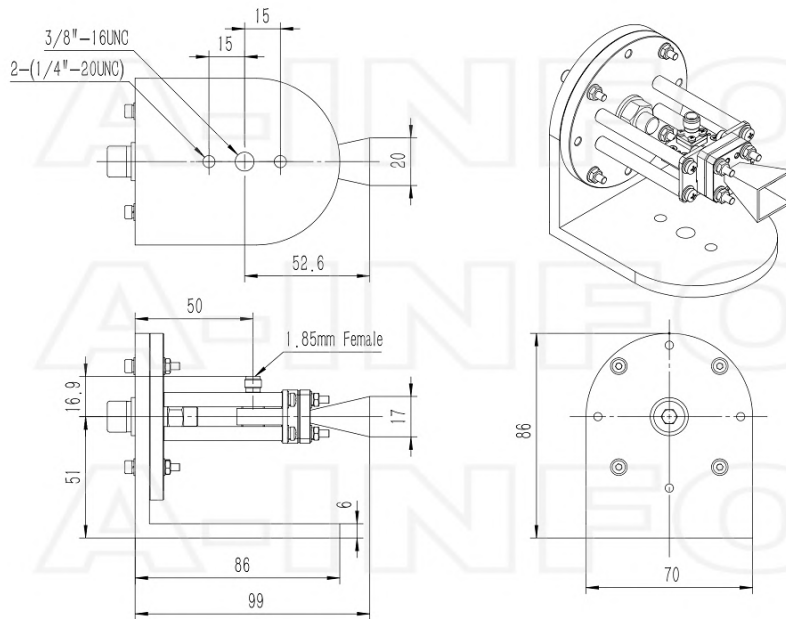

Typical Test Results

Gain

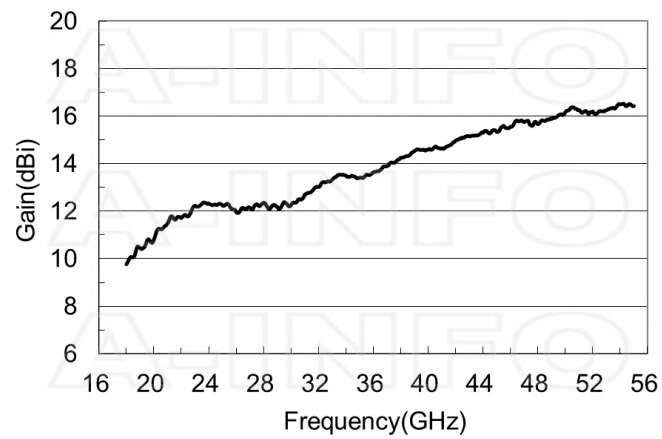

Antenna Factor

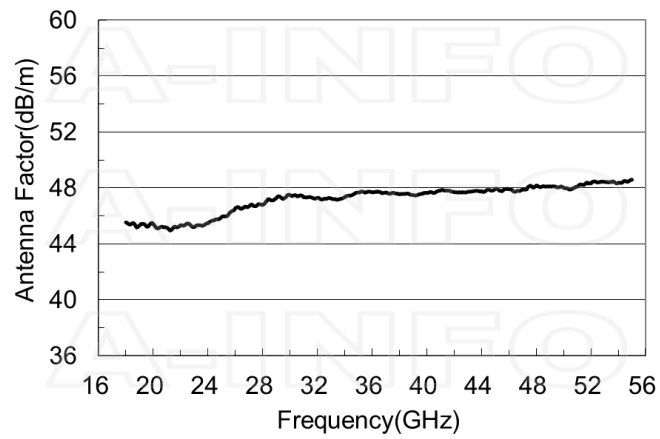

Antenna Factor (Table)

Frequency(GHz)	Gain(dBi)	AF(dB/m)
18.0	9.77	45.55
20.0	10.80	45.43
22.0	11.71	45.34
24.0	12.33	45.49
26.0	11.96	46.55
28.0	12.36	46.79
30.0	12.25	47.50
32.0	13.02	47.29
34.0	13.50	47.34
36.0	13.64	47.70
38.0	14.25	47.55
40.0	14.59	47.67
42.0	14.97	47.71
44.0	15.29	47.79
46.0	15.56	47.91
48.0	15.67	48.17
50.0	16.17	48.02
52.0	16.20	48.33
54.0	16.49	48.37
55.0	16.42	48.59

Cross Polarization Isolation

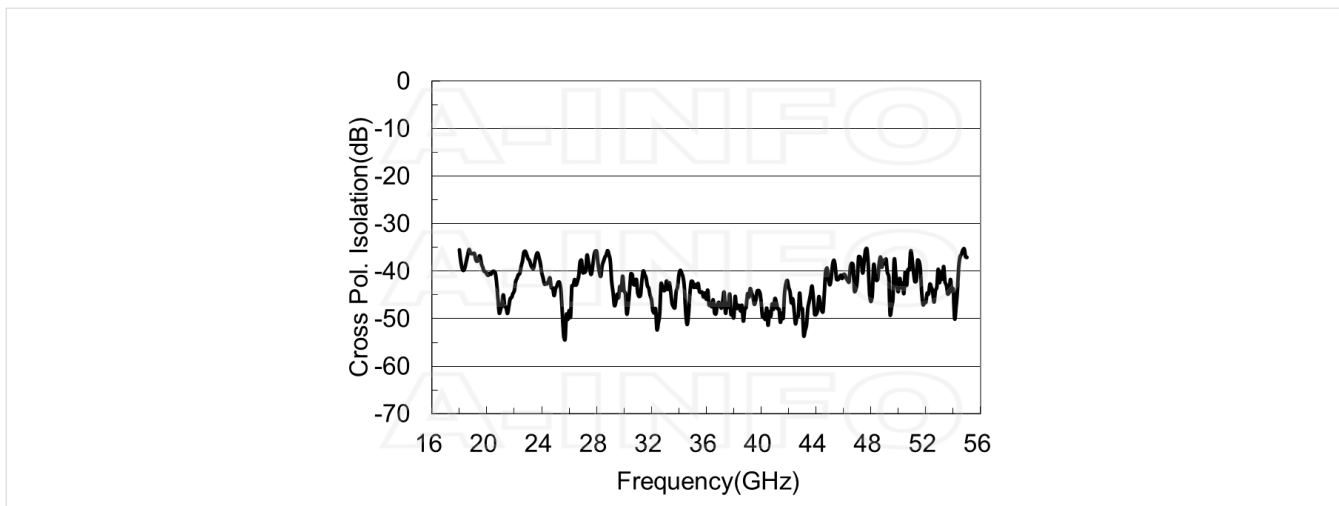

VSWR

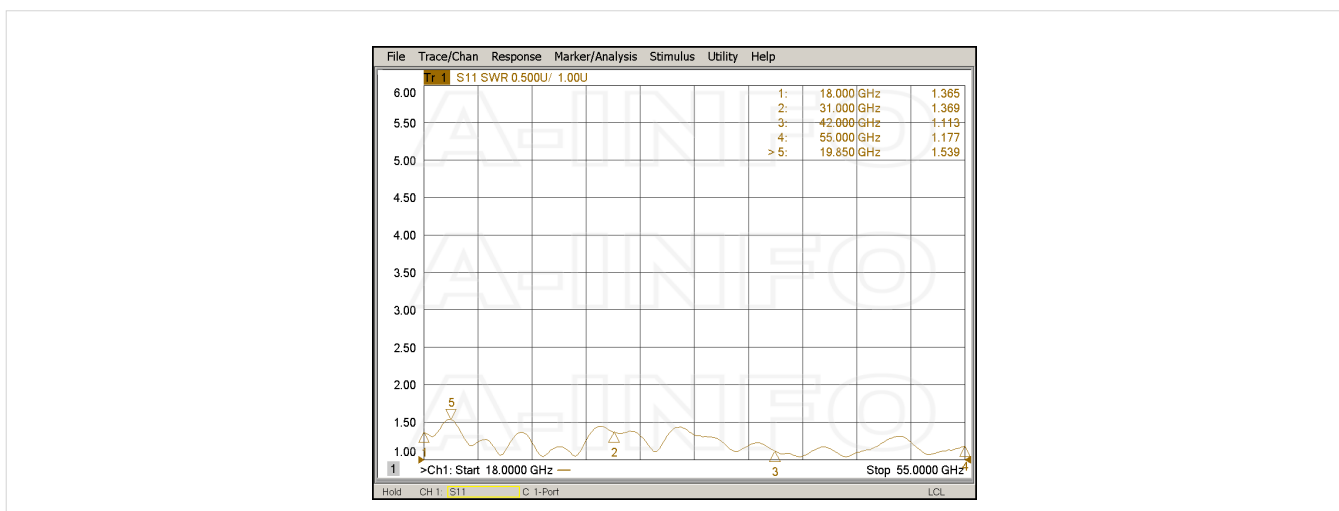

Beamwidth

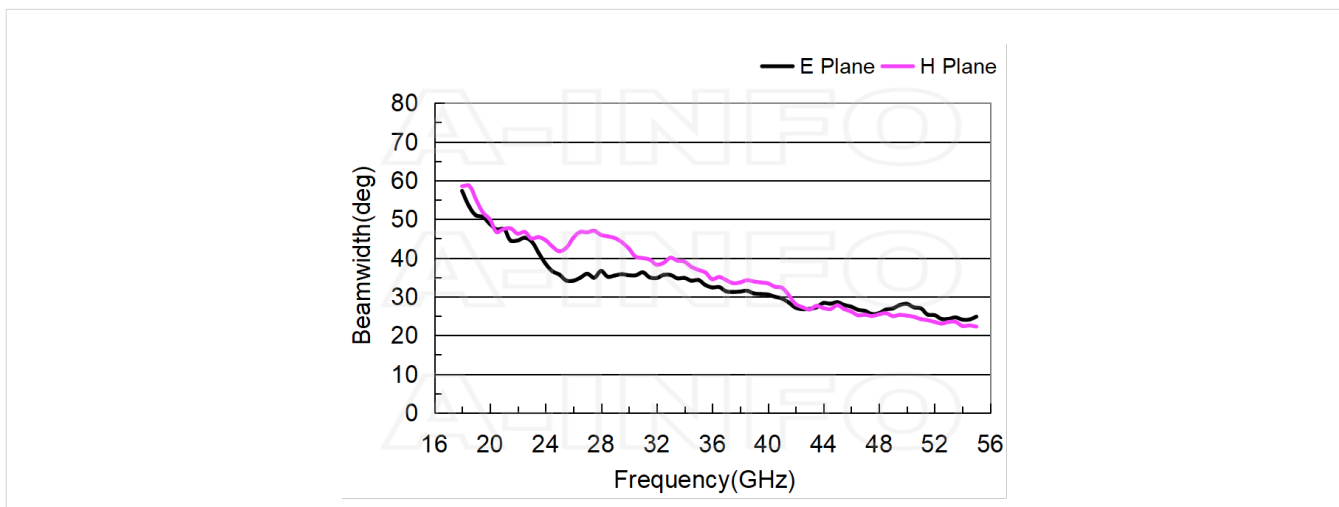

Pattern

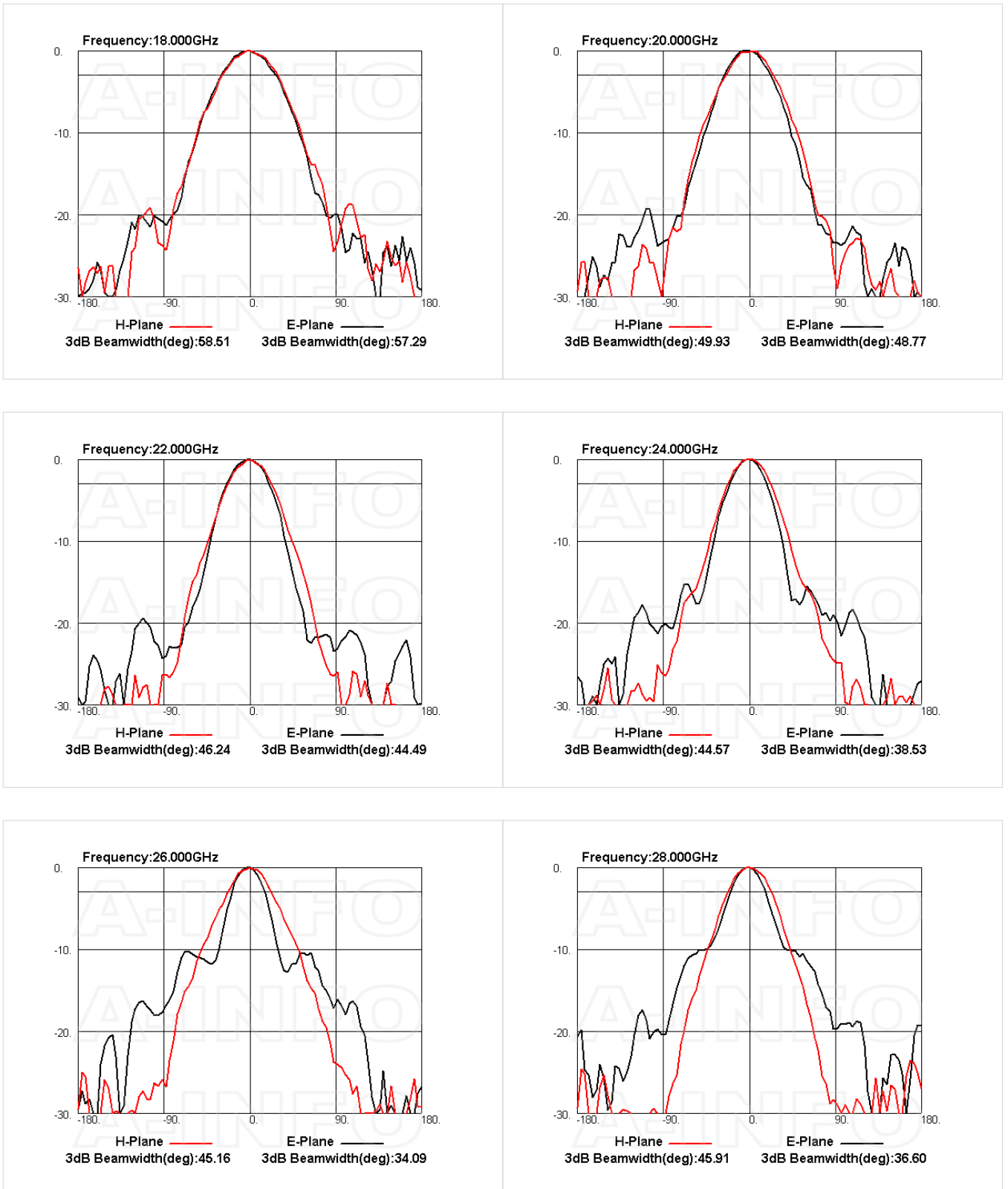

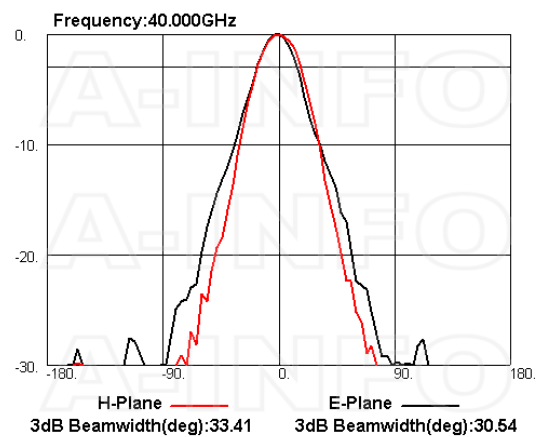
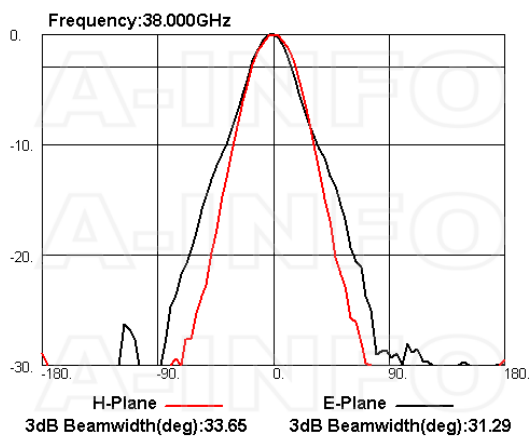
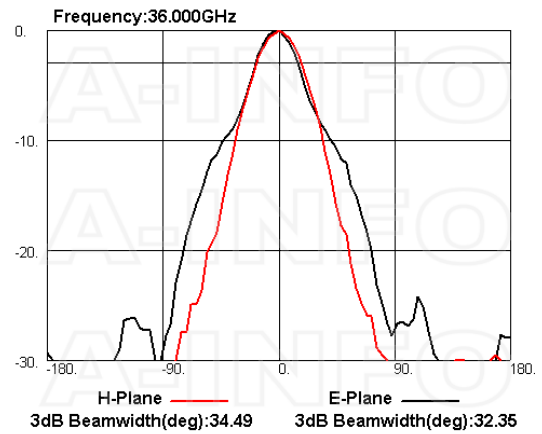
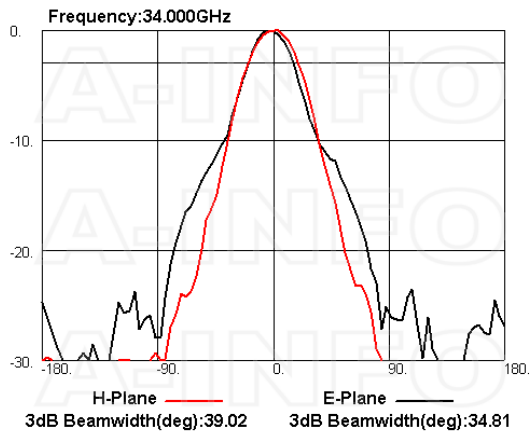
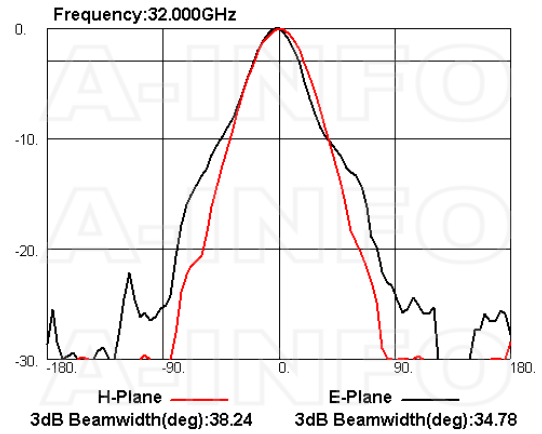
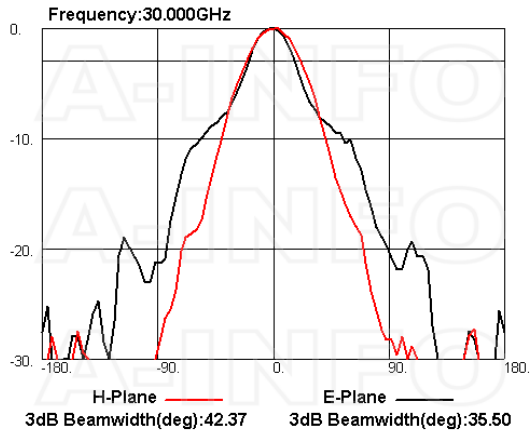

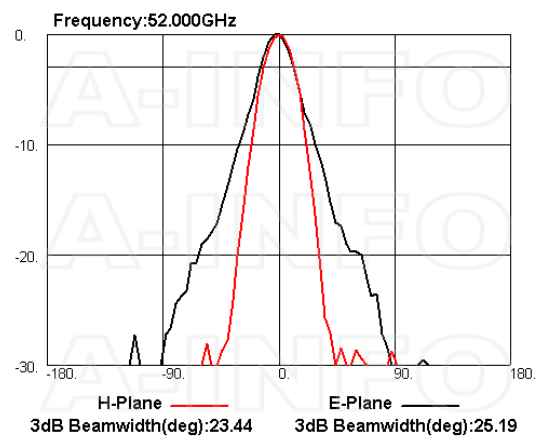
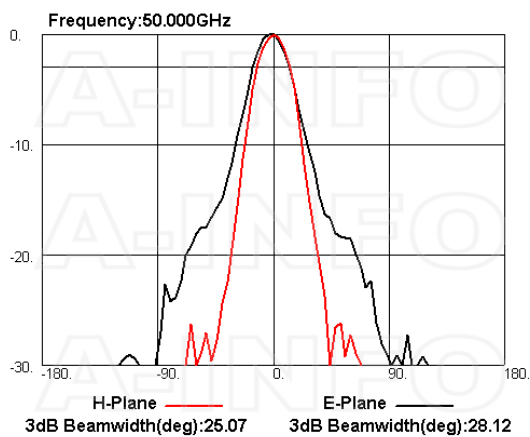
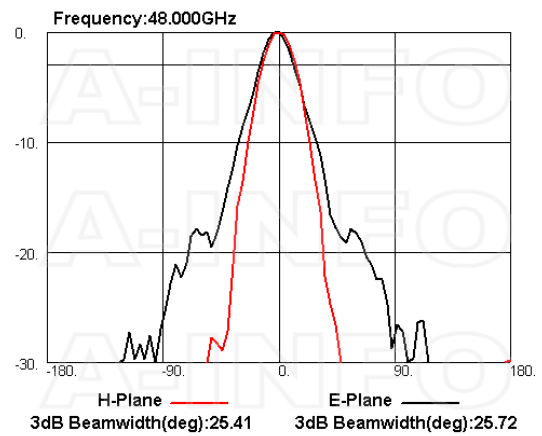
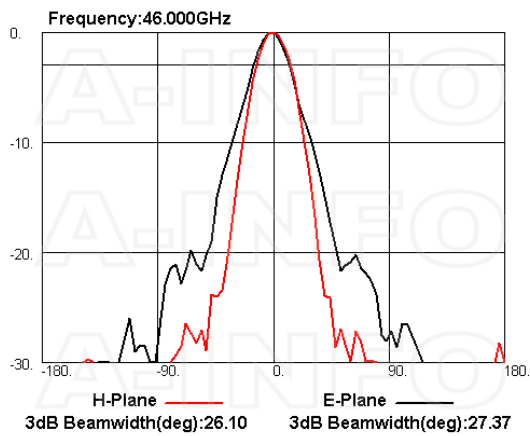
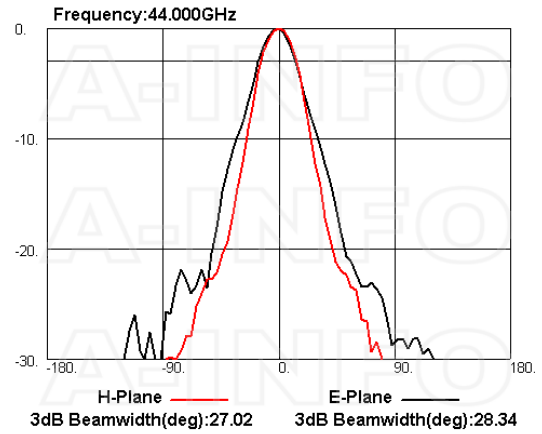
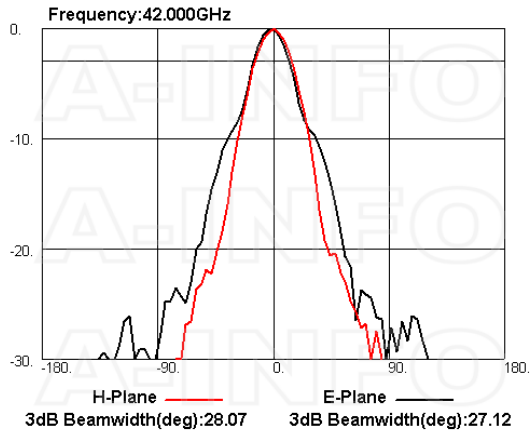

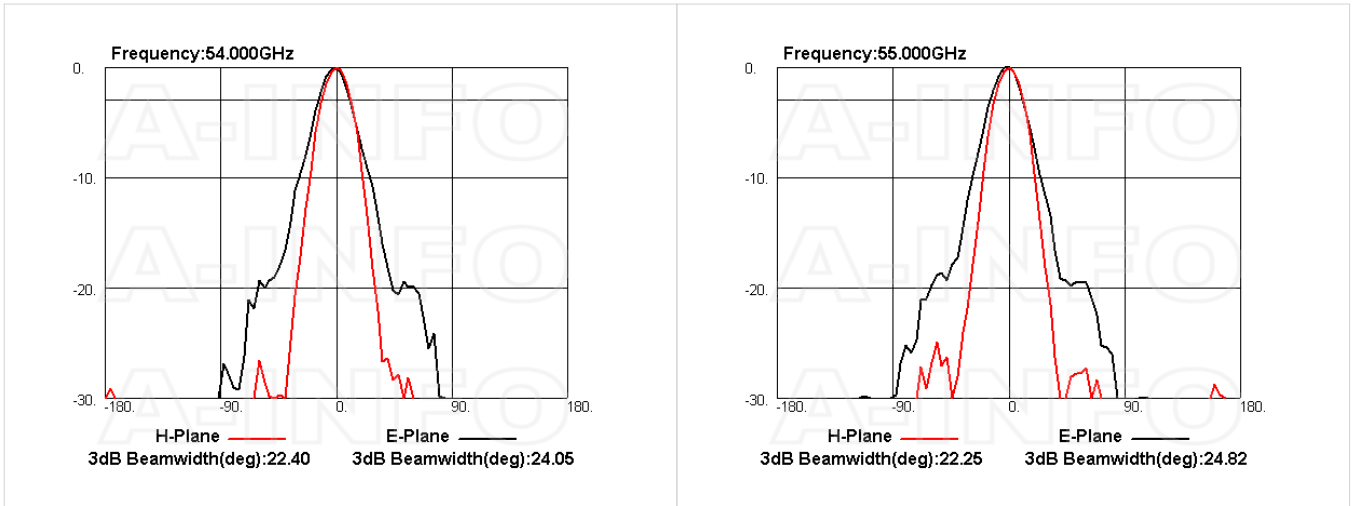

Related Products



LB-180400-10-C-MB Round Type Mounting Bracket



LB-180400-10-C-MBL L Type Mounting Bracket



Tripod_15Kg Al Alloy Tripod



3033HL Wooden Tripod



3033QM Wooden Tripod Metalfree



1.85M-1.85M-B010-200 Flexible Cable Assembly 200mm DC-67GHz 1.85mm Male to 1.85mm Male



1.85M-1.85M-B010-300 Flexible Cable Assembly 300mm DC-67GHz 1.85mm Male to 1.85mm Male



1.85M-1.85M-B010-500 Flexible Cable Assembly 500mm DC-67GHz 1.85mm Male to 1.85mm Male



1.85M-1.85M-B010-1000 Flexible Cable Assembly 1000mm DC-67GHz 1.85mm Male to 1.85mm Male



1.85M-1.85M-B010-1500 Flexible Cable Assembly 1500mm DC-67GHz 1.85mm Male to 1.85mm Male



1.85M-1.85M-B010-2000 Flexible Cable Assembly 2000mm DC-67GHz 1.85mm Male to 1.85mm Male



1.85M-1.85M-B010-3000 Flexible Cable Assembly 3000mm DC-67GHz 1.85mm Male to 1.85mm Male



1.85M-1.85M-B010-5000 Flexible Cable Assembly 5000mm DC-67GHz 1.85mm Male to 1.85mm Male



1.85M-1.85M-B010-10000 Flexible Cable Assembly 10000mm DC-67GHz 1.85mm Male to 1.85mm Male



1.85M-1.85M-B010S-500 Flexible Cable Assembly 500mm DC-67GHz 1.85mm Male to 1.85mm Male



1.85M-1.85M-B010S-1000 Flexible Cable Assembly 1000mm DC-67GHz 1.85mm Male to 1.85mm Male



1.85M-1.85M-B010S-1500 Flexible Cable Assembly 1500mm DC-67GHz 1.85mm Male to 1.85mm Male



1.85M-1.85M-B010S-2000 Flexible Cable Assembly 2000mm DC-67GHz 1.85mm Male to 1.85mm Male



1.85M-1.85M-B010S-3000 Flexible Cable Assembly 3000mm DC-67GHz 1.85mm Male to 1.85mm Male



1.85M-1.85M-B010S-5000 Flexible Cable Assembly 5000mm DC-67GHz 1.85mm Male to 1.85mm Male



1.85M-1.85M-B010S-10000 Flexible Cable Assembly 10000mm DC-67GHz 1.85mm Male to 1.85mm Male



1.85M-1.85F-B010-500 Flexible Cable Assembly 500mm DC-67GHz 1.85mm Male to 1.85mm Female



1.85M-1.85F-B010-1000 Flexible Cable Assembly 1000mm DC-67GHz 1.85mm Male to 1.85mm Female



1.85M-1.85F-B010-1500 Flexible Cable Assembly 1500mm DC-67GHz 1.85mm Male to 1.85mm Female



1.85M-1.85F-B010-2000 Flexible Cable Assembly 2000mm DC-67GHz 1.85mm Male to 1.85mm Female



1.85M-1.85F-B010-2500 Flexible Cable Assembly 2500mm DC-67GHz 1.85mm Male to 1.85mm Female



1.85M-1.85F-B010-3000 Flexible Cable Assembly 3000mm DC-67GHz 1.85mm Male to 1.85mm Female



1.85M-1.85F-B010-5000 Flexible Cable Assembly 5000mm DC-67GHz 1.85mm Male to 1.85mm Female



1.85M-1.85F-B010-10000 Flexible Cable Assembly 10000mm DC-67GHz 1.85mm Male to 1.85mm Female



1.85M-1.85F-B010S-500 Flexible Cable Assembly 500mm DC-67GHz 1.85mm Male to 1.85mm Female



1.85M-1.85F-B010S-1000 Flexible Cable Assembly 1000mm DC-67GHz 1.85mm Male to 1.85mm Female



1.85M-1.85F-B010S-1500 Flexible Cable Assembly 1500mm DC-67GHz 1.85mm Male to 1.85mm Female



1.85M-1.85F-B010S-2000 Flexible Cable Assembly 2000mm DC-67GHz 1.85mm Male to 1.85mm Female



1.85M-1.85F-B010S-3000 Flexible Cable Assembly 3000mm DC-67GHz 1.85mm Male to 1.85mm Female



1.85M-1.85F-B010S-5000 Flexible Cable Assembly 5000mm DC-67GHz 1.85mm Male to 1.85mm Female



1.85M-1.85F-B010S-10000 Flexible Cable Assembly 10000mm DC-67GHz 1.85mm Male to 1.85mm Female

Similar Products



LB-180550-10-C-1.85FSPO Multi Octave Horn Antenna 18-55GHz 10dB Gain 1.85mm Female

About this Datasheet

<ul style="list-style-type: none"> ● Product Information Product Link: https://www.ainfoinc.com/lb-180550-10-c-1-85f-multi-octave-horn-antenna-18-55-ghz-10db-gain-1-85mm-female Data subject to change without notice. © A-INFO INC. 2024. All Rights Reserved 	<ul style="list-style-type: none"> ● Contact Us Address: 60 Tesla, Irvine, CA 92618, USA Website: www.ainfoinc.com Email: sales@ainfoinc.com 	<ul style="list-style-type: none"> ● Phone & Fax Phone: +1-949-639-9688 +1-949-639-9608 Fax: +1-949-639-9670
---	--	---