

LB-180400-20-C-KM Multi Octave Horn Antenna 18-40GHz 20dB Gain  
2.92mm Male

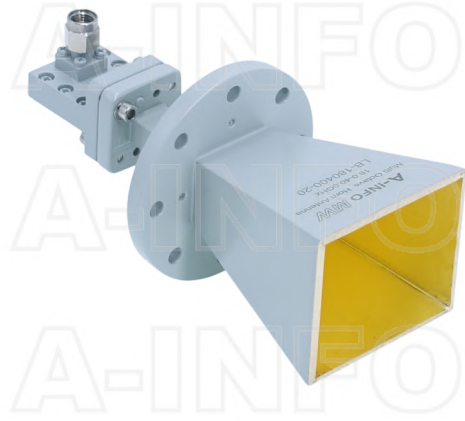

Multi Octave Horn Antenna Operating From 18GHz to 40GHz With a Nominal 20dB Gain With 2.92mm Male Connector

### Product Information

SKU	LB-180400-20-C-KM
-----	-------------------

### Description

Multi octave horn antenna LB-180400-20-C-KM, operating from 18 to 40GHz with a nominal 20dB gain and low VSWR 1.5:1 with 2.92mm Male output connector. The model LB-180400-20-C-KM has uniform gain through its frequency span, providing efficient performance characteristics and directionality. It can handle 20W continuously and 40W peak power. Constructed of high thermal and electrical conductivity durable copper, the antenna will provide years of trouble-free indoor and outdoor service. This multi octave horn antenna is linearly polarized and ideally suited for EMI testing, direction finding, surveillance, antenna gain and pattern measurements and other applications.

## Technical Specification

Electrical Specification		Interface	
Frequency, Min (GHz)	18	Output Type	Coaxial
Frequency, Max (GHz)	40	Connector	2.92mm(K)
Waveguide Type	Double Ridge	Connector Gender	Male
Waveguide Size EIA WRD	WRD180	Mechanical Specification	
Gain, Typ (dBi)	20	Figure	C Type
Polarization	Linear	Body Material	Cu
3dB Beamwidth, E-Plane, Min (Deg.)	10	Finish	Gold Plated and Passivation, Gray Paint
3dB Beamwidth, E-Plane, Max (Deg.)	23	Size, W (mm)	55
3dB Beamwidth, H-Plane, Min (Deg.)	12	Size, H (mm)	55
3dB Beamwidth, H-Plane, Max (Deg.)	26	Size, L (mm)	113
Cross Pol. Isolation, Typ (dB)	35	Weight, (kg)	0.25
VSWR, Typ	1.5:1		
Impedance, (Ohm)	50		
Power Handling, CW, (W)	20		
Power Handling, Peak, (W)	40		

## Additional Information

Application	General Purpose Indoor & Outdoor, Fixed	Solution for	Gain Reference Antenna Measurement Far-field Measurement System Intergration
-------------	-----------------------------------------	--------------	---------------------------------------------------------------------------------------

## Outline Drawing

2.92mm-Male Output (P/N: LB-180400-20-C-KM)

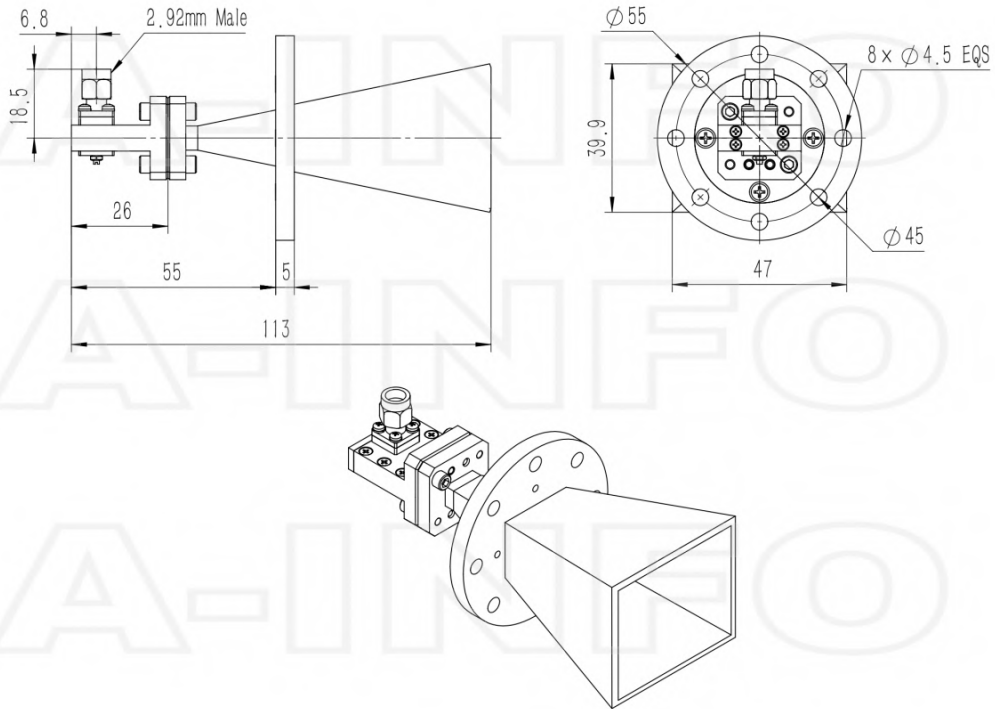

## Typical Test Results

Gain

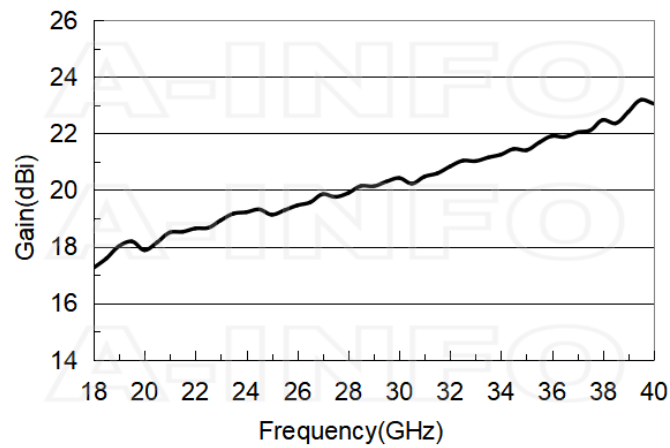

## Antenna Factor

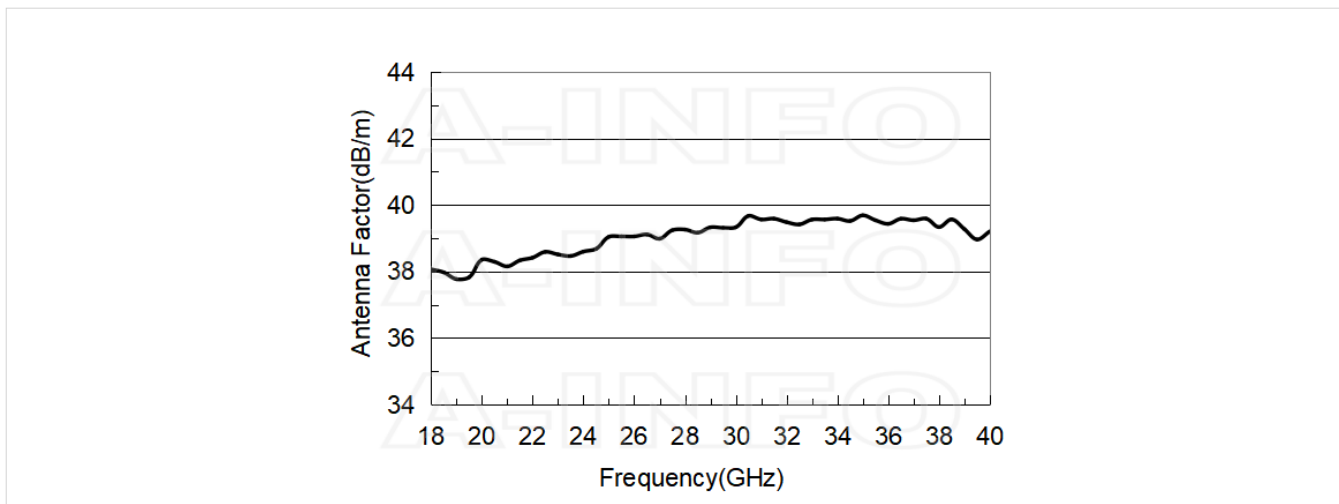

## Antenna Factor (Table)

Frequency(GHz)	Gain(dBi)	AF(dB/m)
18.0	17.25	38.06
20.0	17.88	38.35
22.0	18.64	38.41
24.0	19.22	38.60
26.0	19.46	39.05
28.0	19.89	39.26
30.0	20.42	39.33
32.0	20.83	39.48
34.0	21.25	39.59
36.0	21.90	39.43
38.0	22.47	39.33
40.0	23.05	39.20

## Cross Polarization Isolation

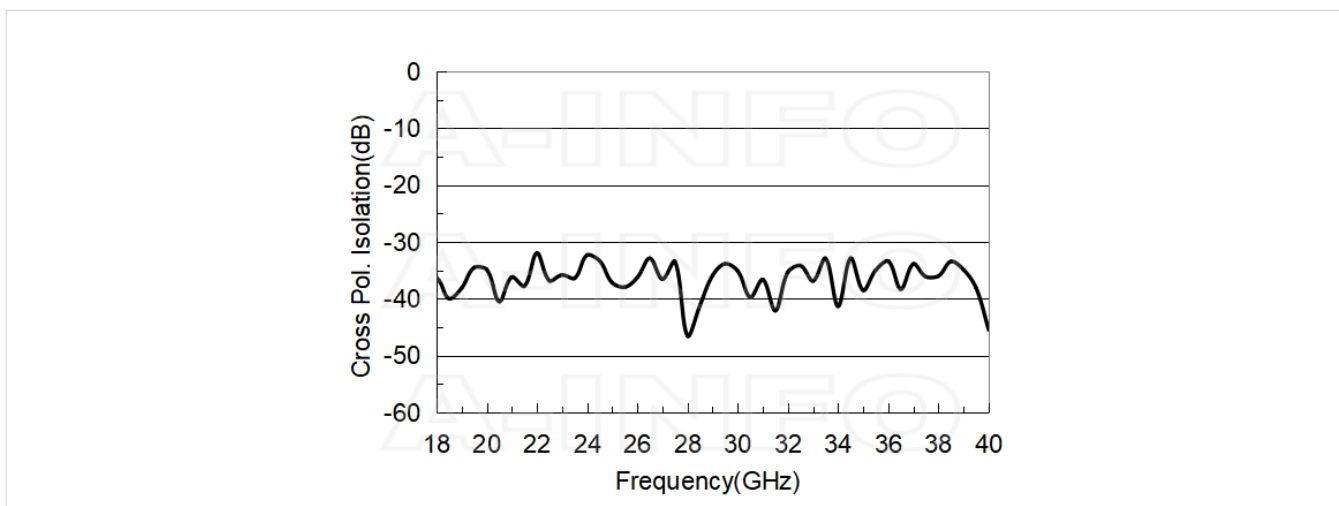

## VSWR

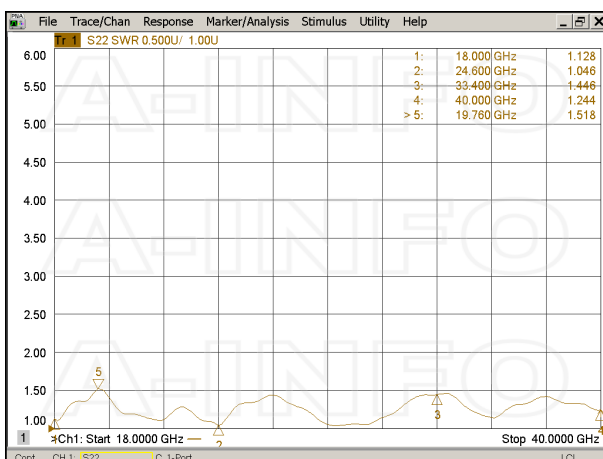

## Beamwidth

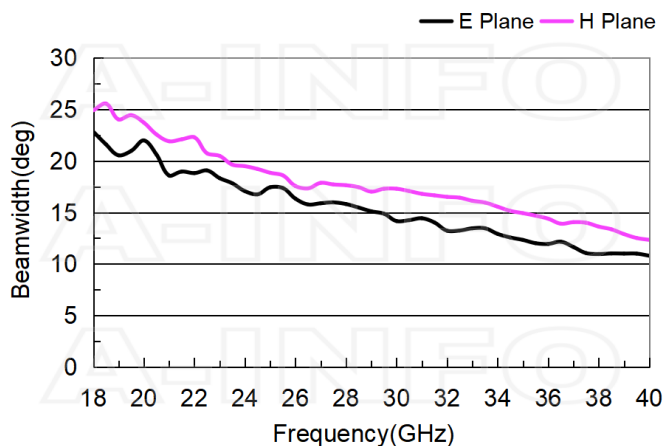

## Pattern

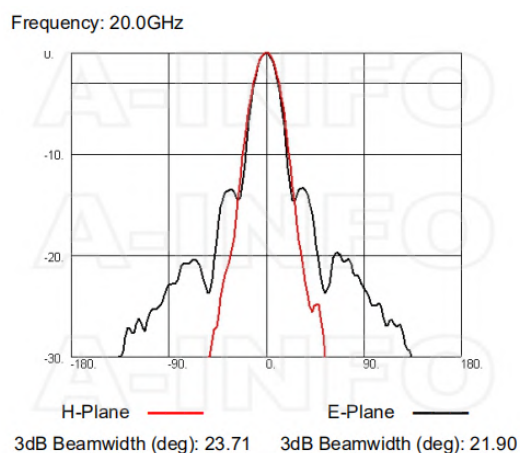
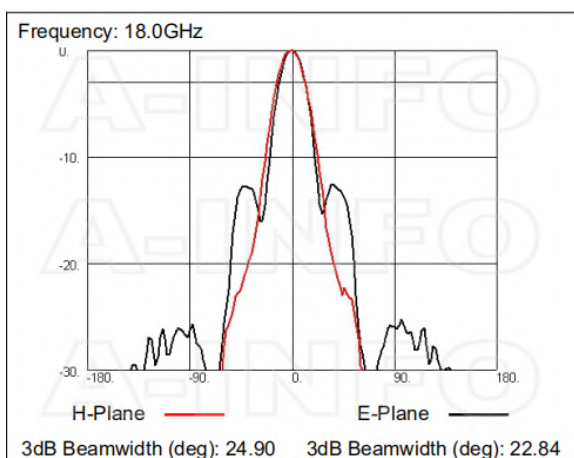

Frequency: 22.0GHz

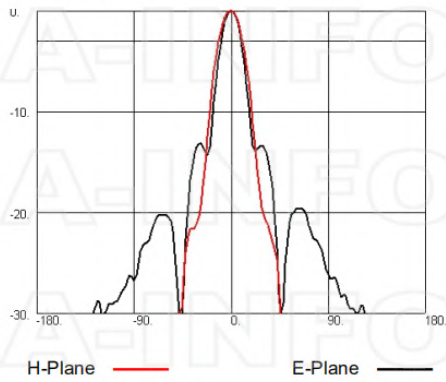

Frequency: 24.0GHz

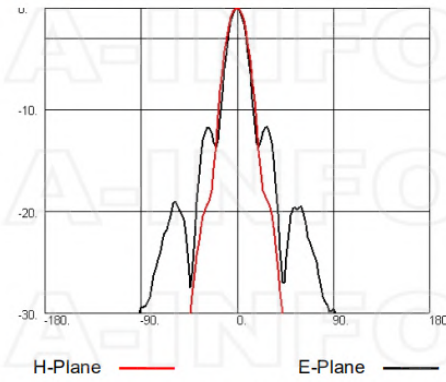

Frequency: 26.0GHz

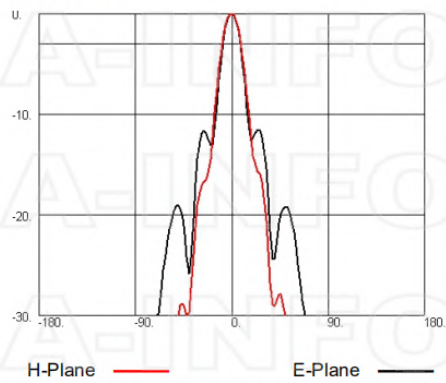

Frequency: 28.0GHz

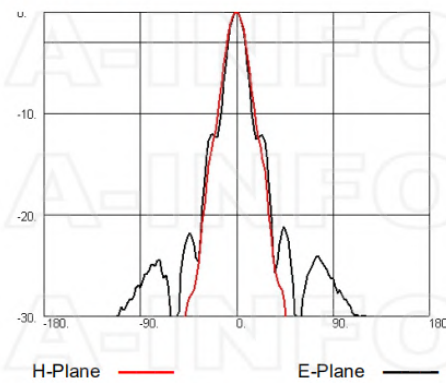

Frequency: 30.0GHz

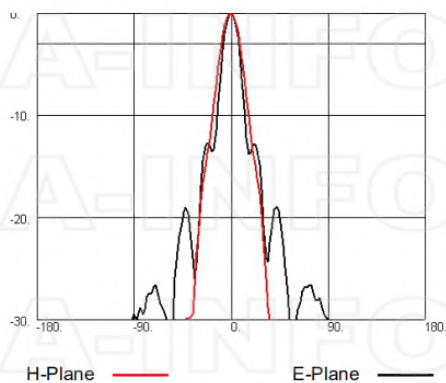

Frequency: 32.0GHz

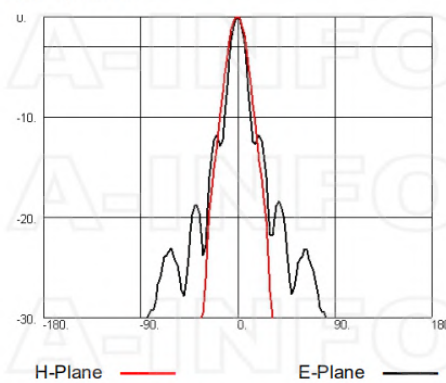

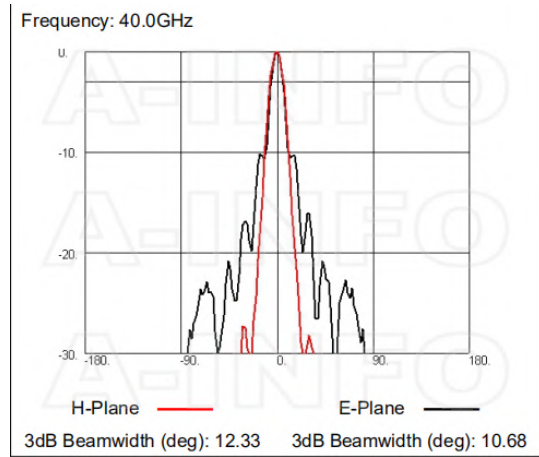
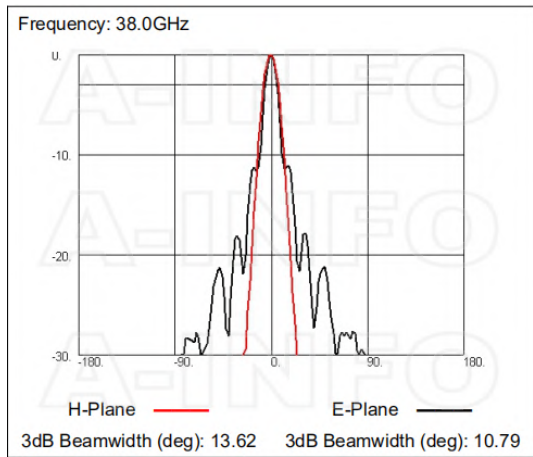
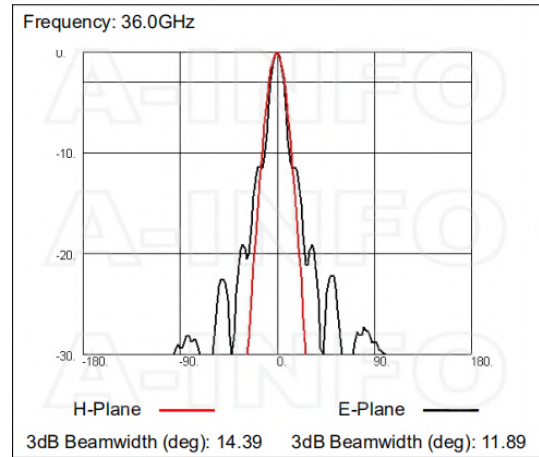
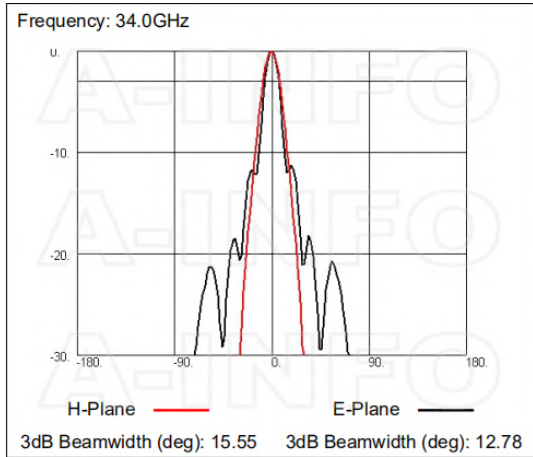

## Related Products



LB-19-25-MB2 Round Type Mounting Bracket



LB-19-25-L2 L type mounting bracket



LB-19-25-MA2 Stinger Type Mounting Bracket



Tripod\_15Kg Al Alloy Tripod



3033HL Wooden Tripod



3033QM Wooden Tripod Metalfree



Carrying Case\_LB-180400-20 Al Alloy Carrying Case



2.92M-2.92M-A050-1000 Flexible Cable Assembly 1000mm DC-40GHz 2.92mm Male to 2.92mm Male



2.92M-2.92M-A050-1500 Flexible Cable Assembly 1500mm DC-40GHz 2.92mm Male to 2.92mm Male



2.92M-2.92M-A050-2000 Flexible Cable Assembly 2000mm DC-40GHz 2.92mm Male to 2.92mm Male



2.92M-2.92M-A050-3000 Flexible Cable Assembly 3000mm DC-40GHz 2.92mm Male to 2.92mm Male



2.92M-2.92M-A050-5000 Flexible Cable Assembly 5000mm DC-40GHz 2.92mm Male to 2.92mm Male



2.92M-2.92M-A050-10000 Flexible Cable Assembly 10000mm DC-40GHz 2.92mm Male to 2.92mm Male

## Similar Products



LB-180400-20-A Multi Octave Horn Antenna 18-40GHz 20dB Gain Double Ridge Waveguide Interface



LB-180400-20-ASPO Multi Octave Horn Antenna 18-40GHz 20dB Gain Double Ridge Waveguide Interface



LB-180400-20-C-KF Multi Octave Horn Antenna 18-40GHz 20dB Gain 2.92mm Female



LB-180400-20-C-KFSPO Multi Octave Horn Antenna 18-40GHz 20dB Gain 2.92mm Female



LB-180400-20-C-2.4F Multi Octave Horn Antenna 18-40GHz  
20dB Gain 2.4mm Female



LB-180400-20-C-2.4FSPO Multi Octave Horn Antenna 18-40GHz  
20dB Gain 2.4mm Female

## About this Datasheet

<ul style="list-style-type: none"> <li>● <b>Product Information</b> Product Link: <a href="https://www.ainfoinc.com/lb-180400-20-c-km-multi-octave-horn-antenna-18-40-ghz-20db-gain-2-92mm-male">https://www.ainfoinc.com/lb-180400-20-c-km-multi-octave-horn-antenna-18-40-ghz-20db-gain-2-92mm-male</a> Data subject to change without notice. © A-INFO INC. 2024. All Rights Reserved</li> </ul>	<ul style="list-style-type: none"> <li>● <b>Contact Us</b> Address: 60 Tesla, Irvine, CA 92618, USA  Website: <a href="http://www.ainfoinc.com">www.ainfoinc.com</a>  Email: <a href="mailto:sales@ainfoinc.com">sales@ainfoinc.com</a></li> </ul>	<ul style="list-style-type: none"> <li>● <b>Phone &amp; Fax</b> Phone: +1-949-639-9688 +1-949-639-9608  Fax: +1-949-639-9670</li> </ul>
---------------------------------------------------------------------------------------------------------------------------------------------------------------------------------------------------------------------------------------------------------------------------------------------------------------------------------------------------------------------------------------------------------------------	------------------------------------------------------------------------------------------------------------------------------------------------------------------------------------------------------------------------------------------------------------------------------------	-----------------------------------------------------------------------------------------------------------------------------------------------------------------