



LB-180400-20-C-2.4FSPO Multi Octave Horn Antenna 18-40GHz 20dB Gain 2.4mm Female

Multi Octave Horn Antenna Operating From 18GHz to 40GHz With a Nominal 20dB Gain With 2.4mm Female Connector

Product Information

SKU	LB-180400-20-C-2.4FSPO
-----	------------------------

Description

Multi octave horn antenna LB-180400-20-C-2.4FSPO, operating from 18 to 40GHz with a nominal 20dB gain and low VSWR 1.5:1 with 2.4mm Female output connector. The model LB-180400-20-C-2.4FSPO has uniform gain through its frequency span, providing efficient performance characteristics and directionality. It can handle 10W continuously and 20W peak power. Constructed of high thermal and electrical conductivity durable copper, the horn comes with a specially designed weatherproof radome which provides excellent protection against the rain and dust but has very little loss across the full operating frequency band. This multi octave horn antenna is linearly polarized and ideally suited for EMI testing, direction finding, surveillance, antenna gain and pattern measurements and other applications.

Technical Specification

Electrical Specification		Interface	
Frequency, Min (GHz)	18	Output Type	Coaxial
Frequency, Max (GHz)	40	Connector	2.4mm
Waveguide Type	Double Ridge	Connector Gender	Female
Waveguide Size EIA WRD	WRD180	Mechanical Specification	
Gain, Typ (dBi)	20	Figure	C Type
Polarization	Linear	Body Material	Cu
3dB Beamwidth, E-Plane, Min (Deg.)	9	Finish	Gold Plated and Passivation, Gray Paint
3dB Beamwidth, E-Plane, Max (Deg.)	26	Size, W (mm)	55
3dB Beamwidth, H-Plane, Min (Deg.)	10	Size, H (mm)	55
3dB Beamwidth, H-Plane, Max (Deg.)	29	Size, L (mm)	115.5
Cross Pol. Isolation, Typ (dB)	35	Weight, (kg)	0.3
VSWR, Typ	1.5:1		
Impedance, (Ohm)	50		
Power Handling, CW, (W)	10		
Power Handling, Peak, (W)	20		

Additional Information

Application	Outdoor, Waterproof and Dustproof, Fixed	Solution for	Gain Reference Antenna Measurement Far-field Measurement System Intergration
-------------	--	--------------	---

Outline Drawing

2.4mm-Female Output with Radome (Option, P/N: LB-180400-20-C-2.4FSPO, Outdoor Application)

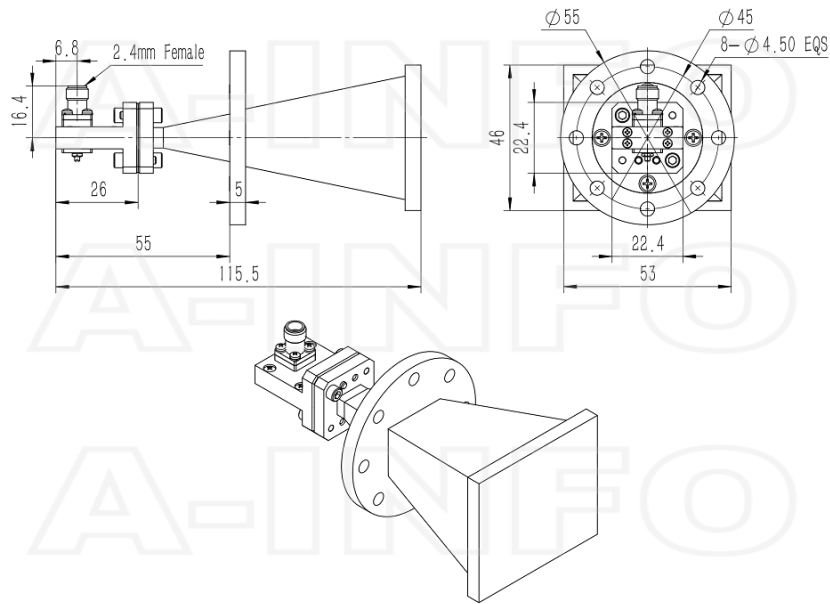

2.4mm-Female Output with Round Mounting Bracket & Radome (Option, P/N: LB-19-25-MB2 & LB-180400-20-C-2.4FSPO, Outdoor Application)

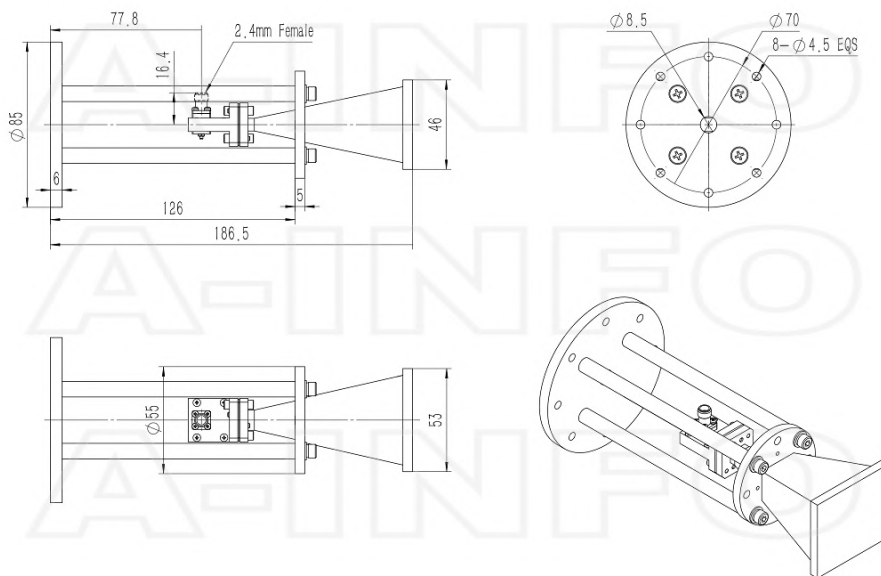

2.4mm-Female Output with L Type Mounting Bracket & Radome (Option, P/N: LB-19-25-L2 & LB-180400-20-C-2.4FSPO, Outdoor Application)

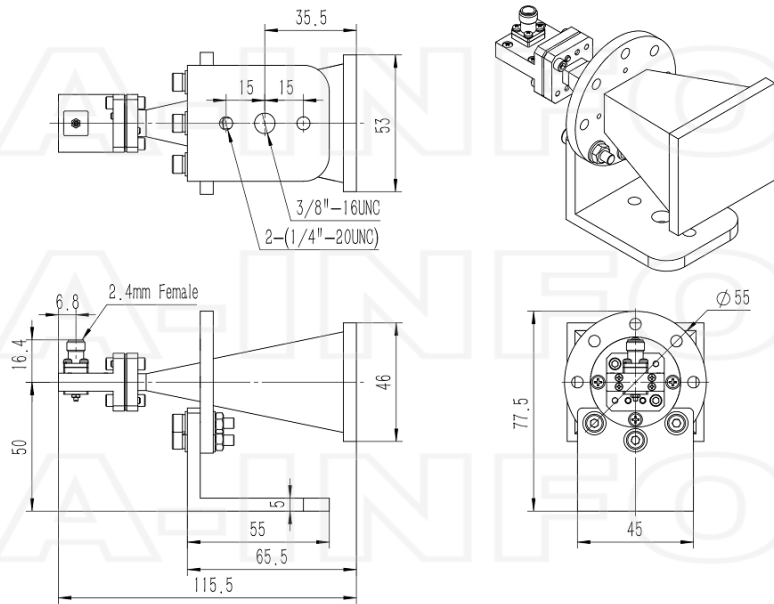

Typical Test Results

Gain

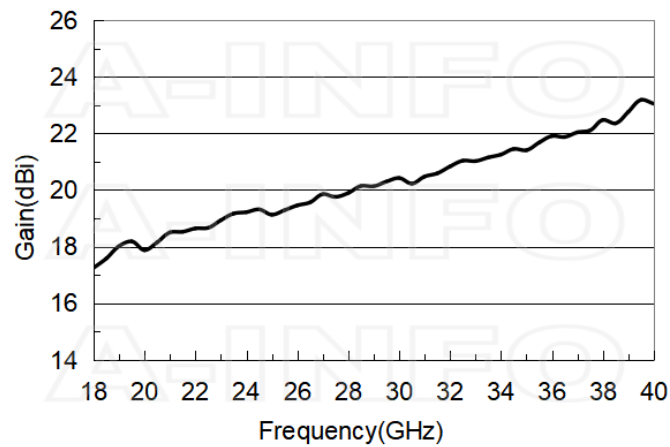

Antenna Factor

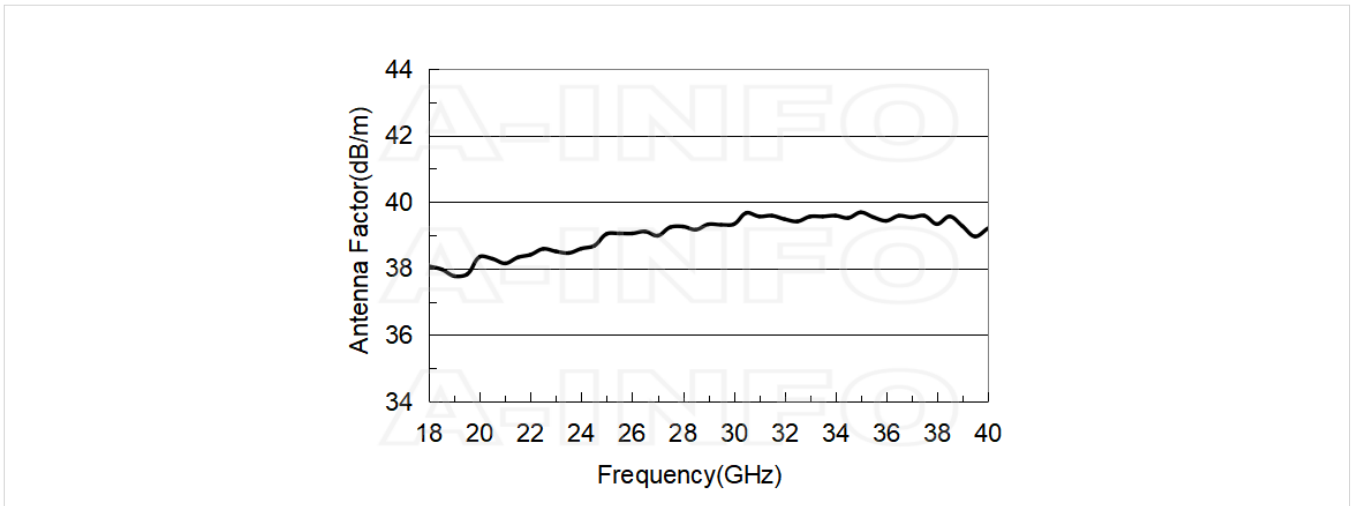

Antenna Factor (Table)

Frequency(GHz)	Gain(dBi)	AF(dB/m)
18.0	17.25	38.06
20.0	17.88	38.35
22.0	18.64	38.41
24.0	19.22	38.60
26.0	19.46	39.05
28.0	19.89	39.26
30.0	20.42	39.33
32.0	20.83	39.48
34.0	21.25	39.59
36.0	21.90	39.43
38.0	22.47	39.33
40.0	23.05	39.20

Cross Polarization Isolation

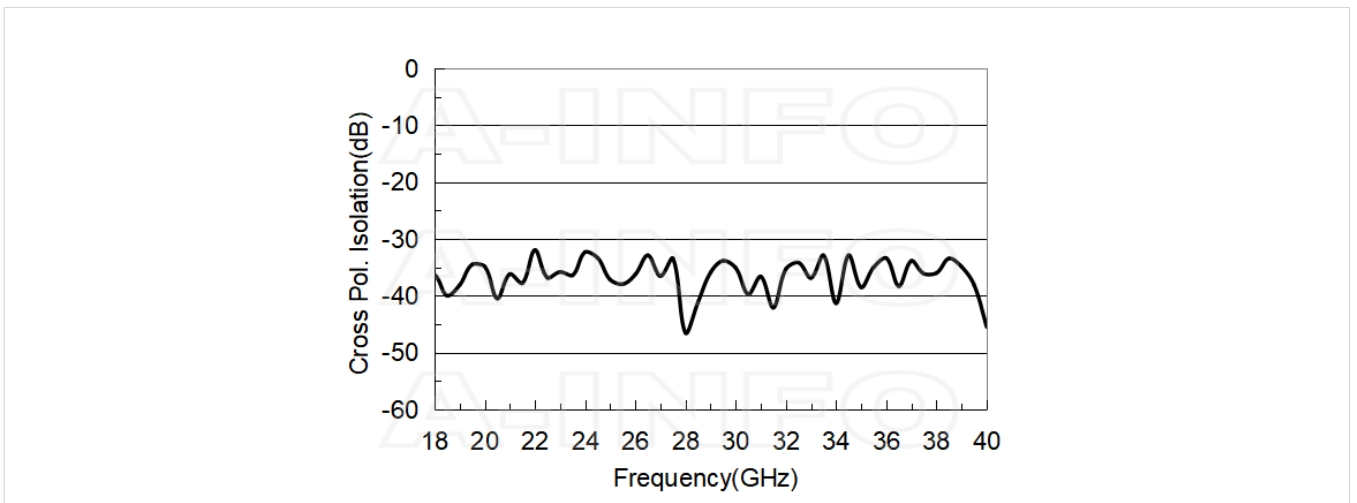

VSWR

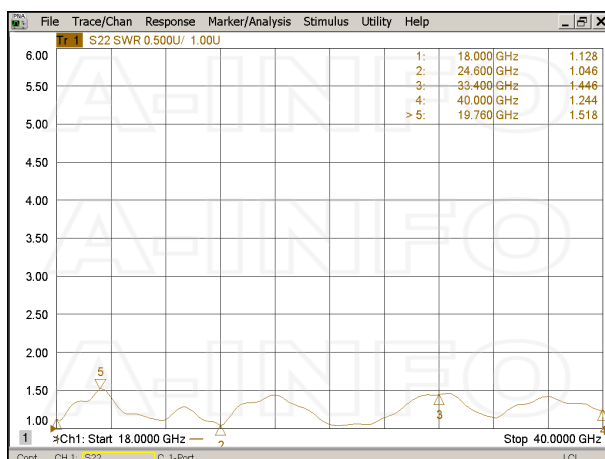

Beamwidth

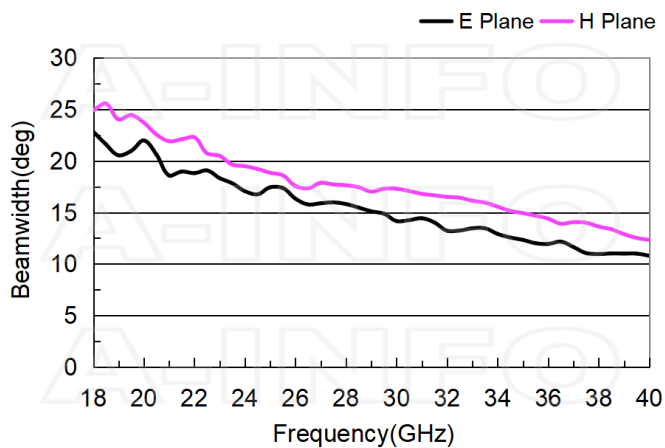

Pattern

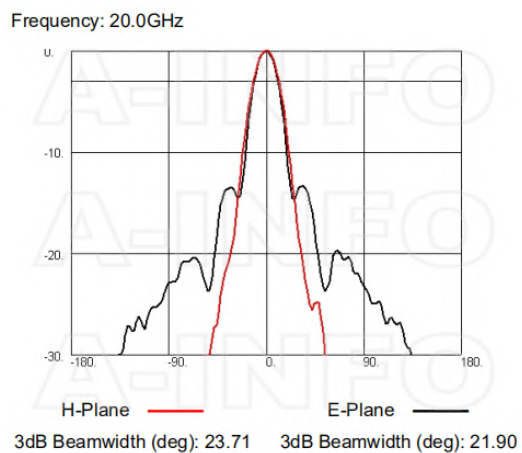
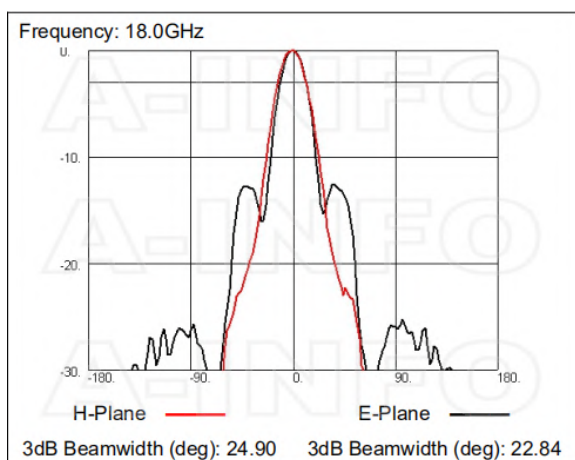

Frequency: 22.0GHz

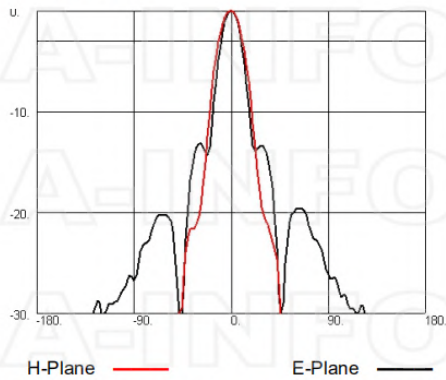

Frequency: 24.0GHz

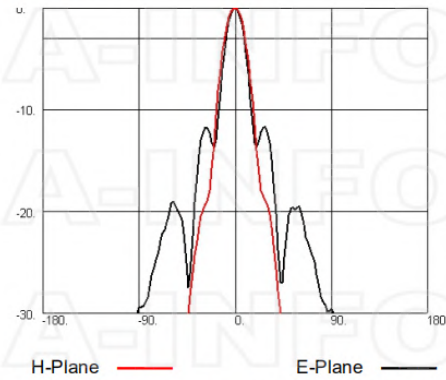

Frequency: 26.0GHz

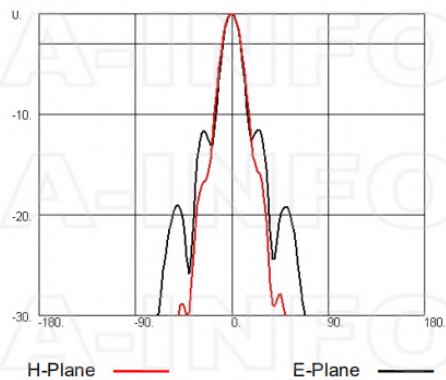

Frequency: 28.0GHz

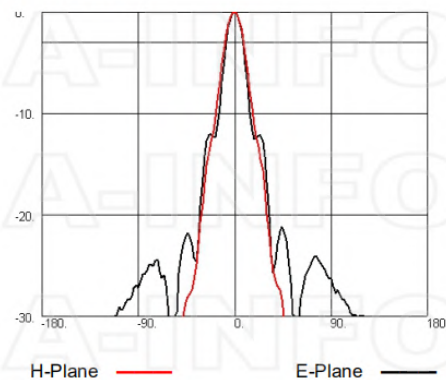

Frequency: 30.0GHz

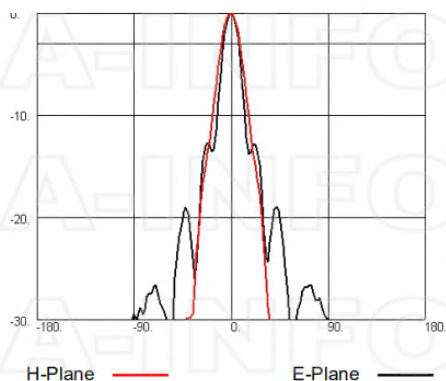

Frequency: 32.0GHz

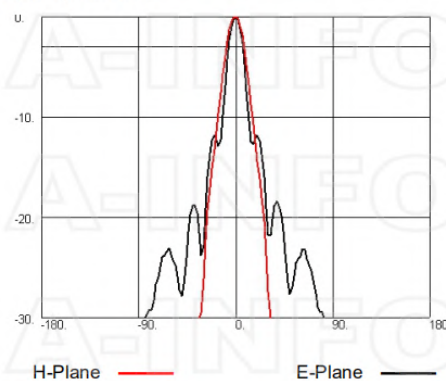

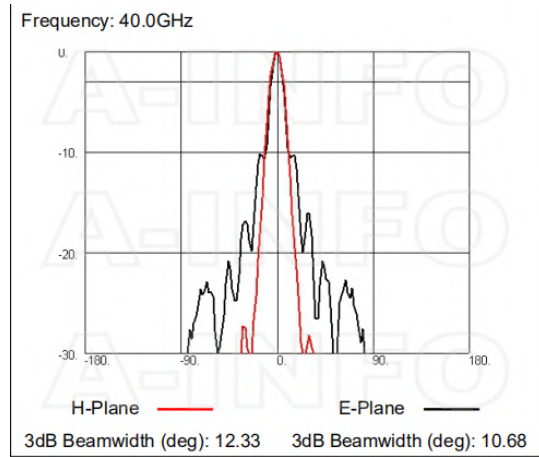
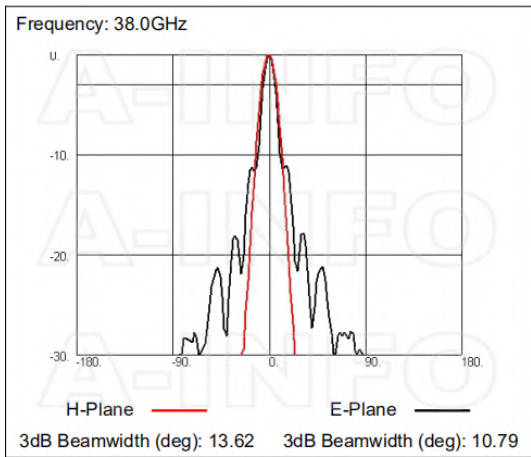
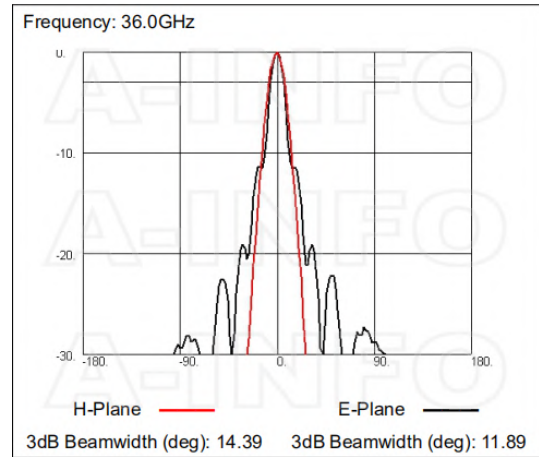
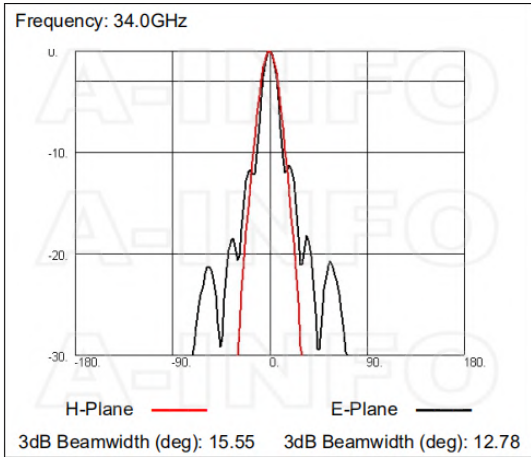

Related Products



LB-19-25-MB2 Round Type Mounting Bracket



LB-19-25-L2 L type mounting bracket



LB-19-25-MA2 Stinger Type Mounting Bracket



Tripod_15Kg Al Alloy Tripod



3033HL Wooden Tripod



3033QM Wooden Tripod
Metalfree



Carrying Case_LB-180400-20 Al
Alloy Carrying Case



2.4M-2.4M-A050-500 Flexible
Cable Assembly 500mm DC-
40GHz 2.4mm Male to 2.4mm
Male



2.4M-2.4M-A050-1000 Flexible
Cable Assembly 1000mm DC-
40GHz 2.4mm Male to 2.4mm
Male



2.4M-2.4M-A050-1500 Flexible
Cable Assembly 1500mm DC-
40GHz 2.4mm Male to 2.4mm
Male



2.4M-2.4M-A050-2000 Flexible
Cable Assembly 2000mm DC-
40GHz 2.4mm Male to 2.4mm
Male



2.4M-2.4M-A050-3000 Flexible
Cable Assembly 3000mm DC-
40GHz 2.4mm Male to 2.4mm
Male



2.4M-2.4M-A050-5000 Flexible
Cable Assembly 5000mm DC-
40GHz 2.4mm Male to 2.4mm
Male



2.4M-2.4M-A050-10000 Flexible
Cable Assembly 10000mm DC-
40GHz 2.4mm Male to 2.4mm
Male



2.4M-2.4M-B020-300 Flexible
Cable Assembly 300mm DC-
50GHz 2.4mm Male to 2.4mm
Male

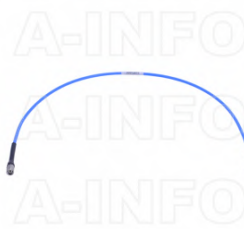

2.4M-2.4M-B020-500 Flexible
Cable Assembly 500mm DC-
50GHz 2.4mm Male to 2.4mm
Male



2.4M-2.4M-B020-1000 Flexible
Cable Assembly 1000mm DC-
50GHz 2.4mm Male to 2.4mm
Male



2.4M-2.4M-B020-1500 Flexible
Cable Assembly 1500mm DC-
50GHz 2.4mm Male to 2.4mm
Male



2.4M-2.4M-B020-2000 Flexible
Cable Assembly 2000mm DC-
50GHz 2.4mm Male to 2.4mm
Male



2.4M-2.4M-B020-3000 Flexible
Cable Assembly 3000mm DC-
50GHz 2.4mm Male to 2.4mm
Male



2.4M-2.4M-B020-5000 Flexible Cable Assembly 5000mm DC-50GHz 2.4mm Male to 2.4mm Male



2.4M-2.4M-B020-10000 Flexible Cable Assembly 10000mm DC-50GHz 2.4mm Male to 2.4mm Male



2.4M-2.4F-B020S-500 Flexible Cable Assembly 500mm DC-50GHz 2.4mm Male to 2.4mm Female



2.4M-2.4F-B020S-1000 Flexible Cable Assembly 1000mm DC-50GHz 2.4mm Male to 2.4mm Female



2.4M-2.4F-B020S-1500 Flexible Cable Assembly 1500mm DC-50GHz 2.4mm Male to 2.4mm Female



2.4M-2.4F-B020S-2000 Flexible Cable Assembly 2000mm DC-50GHz 2.4mm Male to 2.4mm Female



2.4M-2.4F-B020S-3000 Flexible Cable Assembly 3000mm DC-50GHz 2.4mm Male to 2.4mm Female



2.4M-2.4F-B020S-5000 Flexible Cable Assembly 5000mm DC-50GHz 2.4mm Male to 2.4mm Female

Similar Products



LB-180400-20-A Multi Octave Horn Antenna 18-40GHz 20dB Gain Double Ridge Waveguide Interface



LB-180400-20-ASPO Multi Octave Horn Antenna 18-40GHz 20dB Gain Double Ridge Waveguide Interface



LB-180400-20-C-KF Multi Octave Horn Antenna 18-40GHz 20dB Gain 2.92mm Female



LB-180400-20-C-KM Multi Octave Horn Antenna 18-40GHz 20dB Gain 2.92mm Male



LB-180400-20-C-KFSPO Multi Octave Horn Antenna 18-40GHz 20dB Gain 2.92mm Female



LB-180400-20-C-2.4F Multi Octave Horn Antenna 18-40GHz 20dB Gain 2.4mm Female

About this Datasheet

<ul style="list-style-type: none">● Product Information Product Link: https://www.ainfoinc.com/lb-180400-20-c-2-4fspo-multi-octave-horn-antenna-18-40-ghz-20db-gain-2-4mm-female Data subject to change without notice. © A-INFO INC. 2024. All Rights Reserved	<ul style="list-style-type: none">● Contact Us Address: 60 Tesla, Irvine, CA 92618, USA Website: www.ainfoinc.com Email: sales@ainfoinc.com	<ul style="list-style-type: none">● Phone & Fax Phone: +1-949-639-9688 +1-949-639-9608 Fax: +1-949-639-9670
---	--	---