

LB-180400-20-C-2.4F Multi Octave Horn Antenna 18-40GHz 20dB Gain 2.4mm Female



Multi Octave Horn Antenna Operating From 18GHz to 40GHz With a Nominal 20dB Gain With 2.4mm Female Connector

### Product Information

SKU	LB-180400-20-C-2.4F
-----	---------------------

### Description

Multi octave horn antenna LB-180400-20-C-2.4F, operating from 18 to 40GHz with a nominal 20dB gain and low VSWR 1.5:1 with 2.4mm Female output connector. The model LB-180400-20-C-2.4F has uniform gain through its frequency span, providing efficient performance characteristics and directionality. It can handle 10W continuously and 20W peak power. Constructed of high thermal and electrical conductivity durable copper, the antenna will provide years of trouble-free indoor and outdoor service. This multi octave horn antenna is linearly polarized and ideally suited for EMI testing, direction finding, surveillance, antenna gain and pattern measurements and other applications.

## Technical Specification

Electrical Specification		Interface	
Frequency, Min (GHz)	18	Output Type	Coaxial
Frequency, Max (GHz)	40	Connector	2.4mm
Waveguide Type	Double Ridge	Connector Gender	Female
Waveguide Size EIA WRD	WRD180	Mechanical Specification	
Gain, Typ (dBi)	20	Figure	C Type
Polarization	Linear	Body Material	Cu
3dB Beamwidth, E-Plane, Min (Deg.)	9	Finish	Gold Plated and Passivation, Gray Paint
3dB Beamwidth, E-Plane, Max (Deg.)	26	Size, W (mm)	55
3dB Beamwidth, H-Plane, Min (Deg.)	10	Size, H (mm)	55
3dB Beamwidth, H-Plane, Max (Deg.)	29	Size, L (mm)	113
Cross Pol. Isolation, Typ (dB)	35	Weight, (kg)	0.25
VSWR, Typ	1.5:1		
Impedance, (Ohm)	50		
Power Handling, CW, (W)	10		
Power Handling, Peak, (W)	20		

## Additional Information

Application	General Purpose Indoor & Outdoor, Fixed	Solution for	Gain Reference Antenna Measurement Far-field Measurement System Intergration
-------------	---	--------------	---

## Outline Drawing

2.4mm-Female Output (P/N: LB-180400-20-C-2.4F)

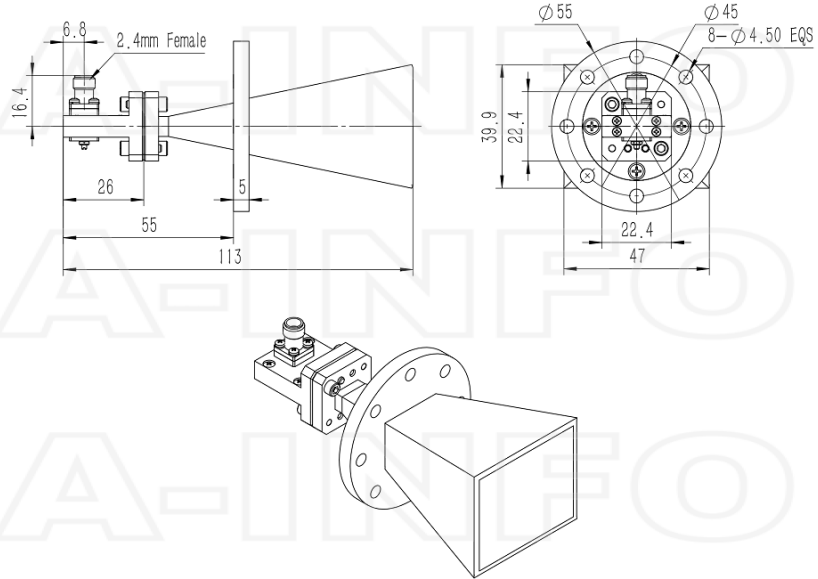

2.4mm-Female Output with Round Mounting Bracket (Option, P/N: LB-19-25-MB2)

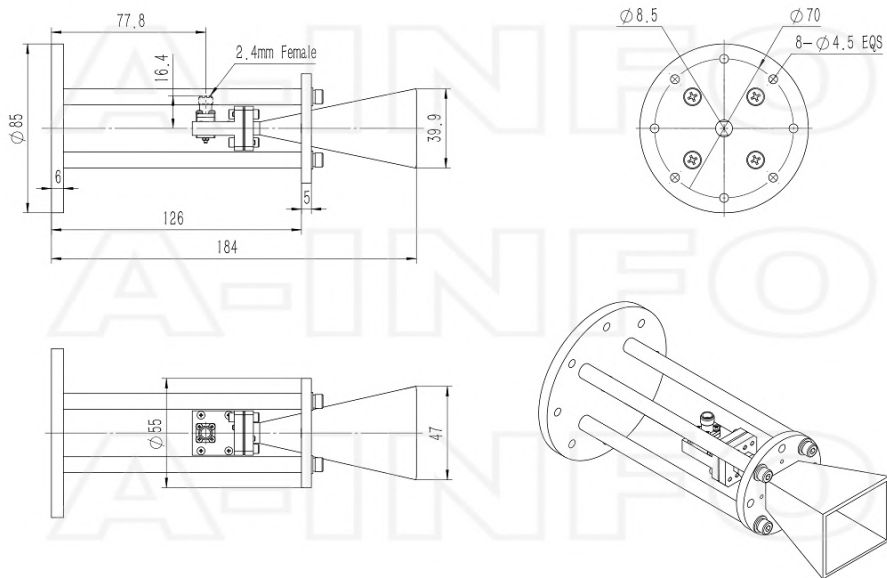

2.4mm-Female Output with L Type Mounting Bracket (Option, P/N:LB-19-25-L2)

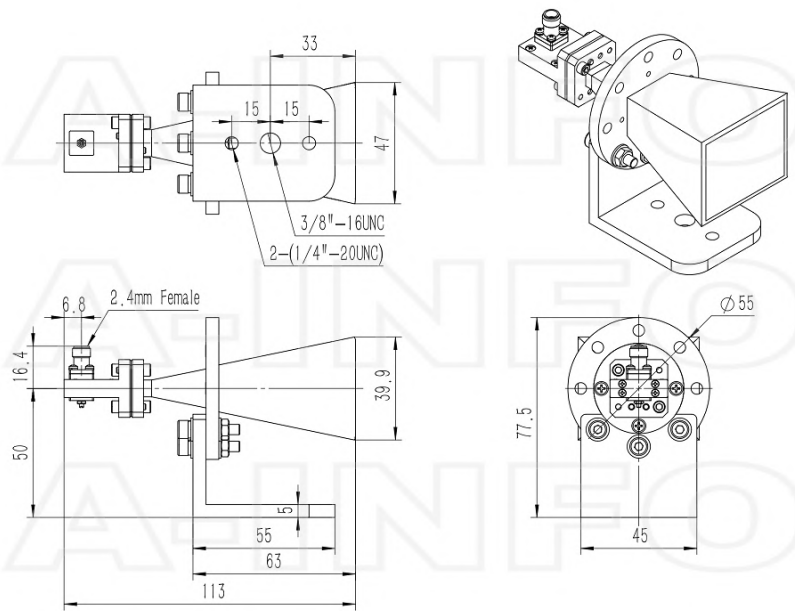

## Typical Test Results

### Gain

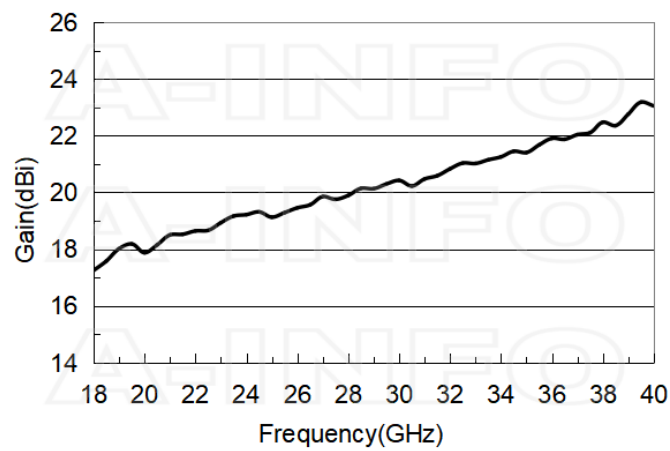

## Antenna Factor

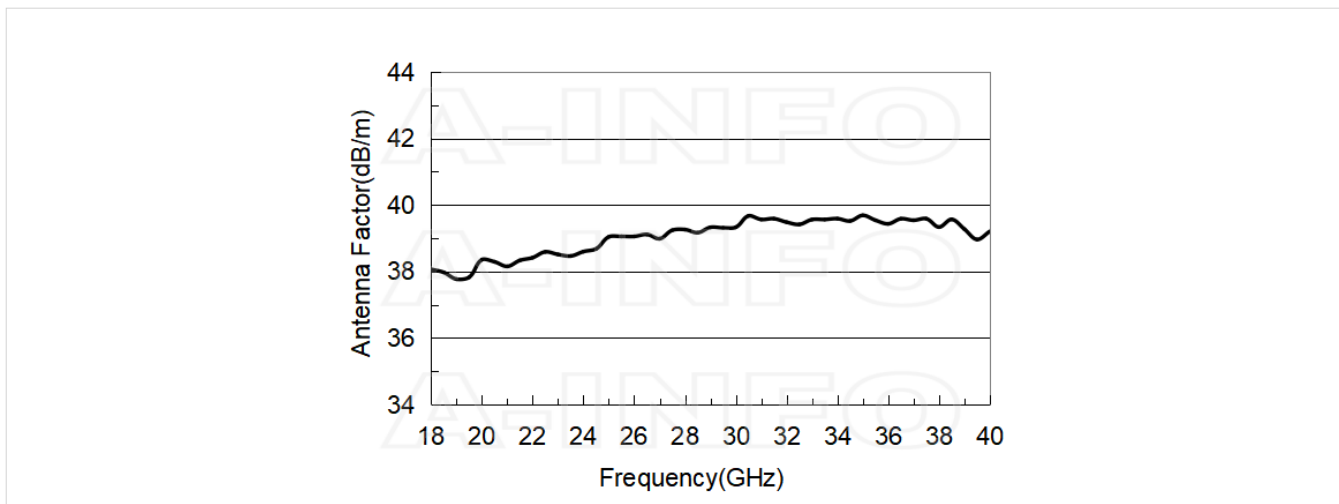

## Antenna Factor (Table)

Frequency(GHz)	Gain(dBi)	AF(dB/m)
18.0	17.25	38.06
20.0	17.88	38.35
22.0	18.64	38.41
24.0	19.22	38.60
26.0	19.46	39.05
28.0	19.89	39.26
30.0	20.42	39.33
32.0	20.83	39.48
34.0	21.25	39.59
36.0	21.90	39.43
38.0	22.47	39.33
40.0	23.05	39.20

## Cross Polarization Isolation

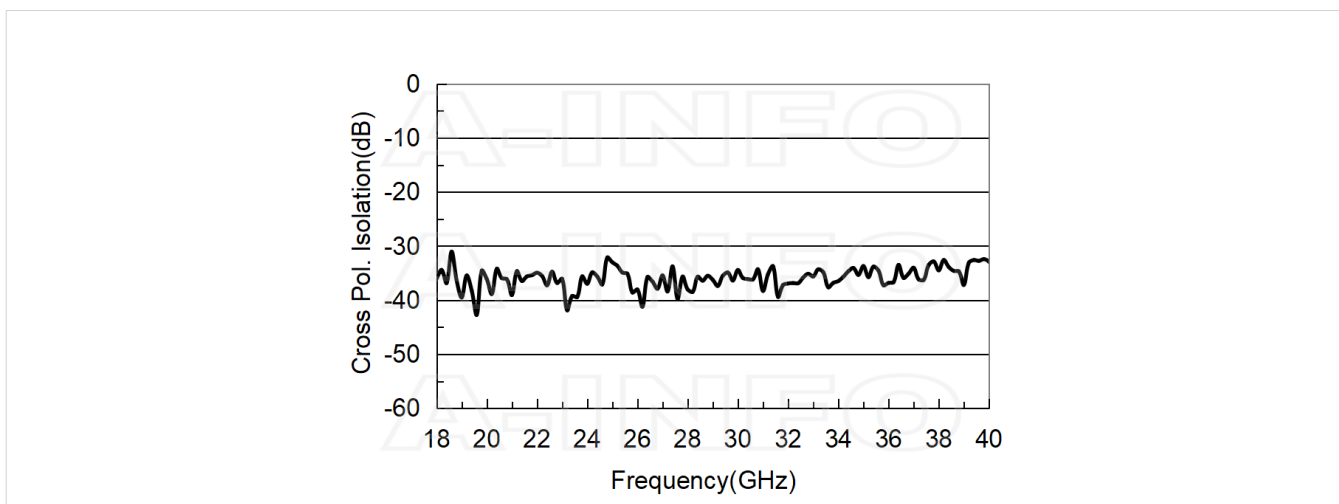

## VSWR

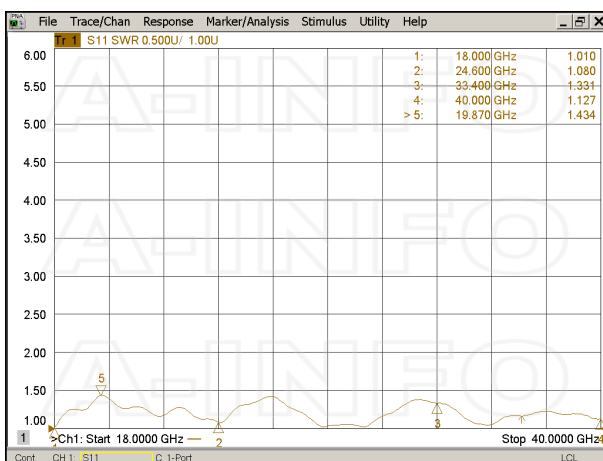

## Beamwidth

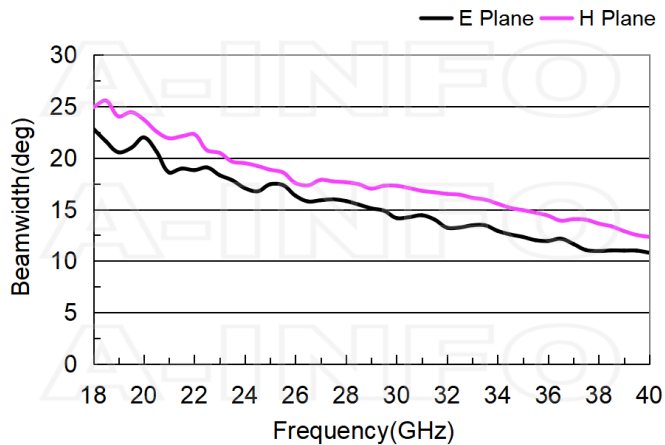

## Pattern

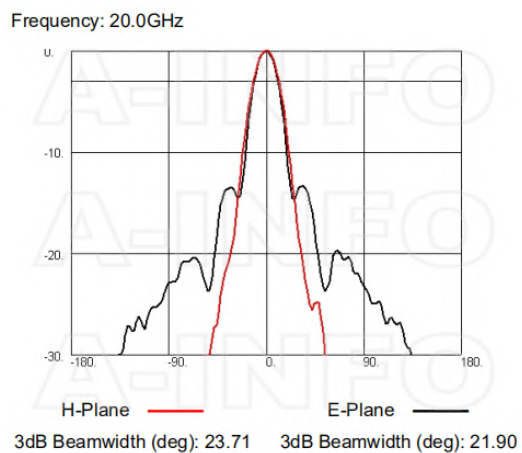
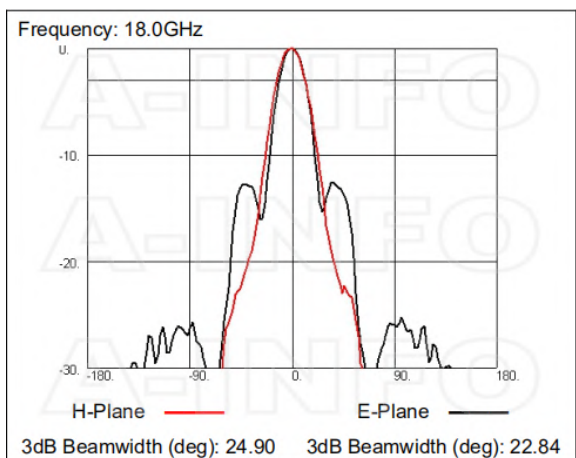

Frequency: 22.0GHz

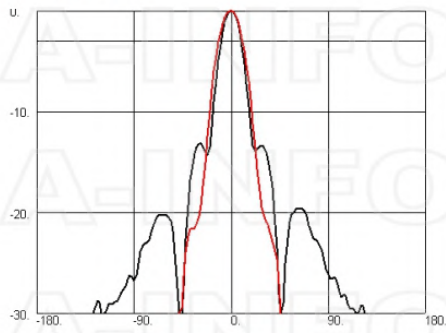

H-Plane — E-Plane —  
 3dB Beamwidth (deg): 22.29    3dB Beamwidth (deg): 18.69

Frequency: 24.0GHz

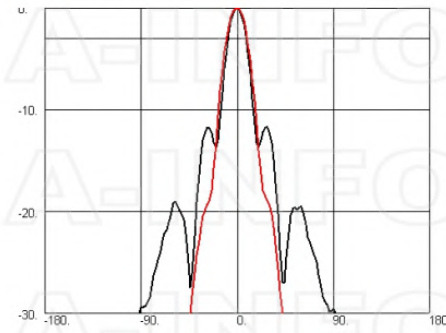

H-Plane — E-Plane —  
 3dB Beamwidth (deg): 19.48    3dB Beamwidth (deg): 17.00

Frequency: 26.0GHz

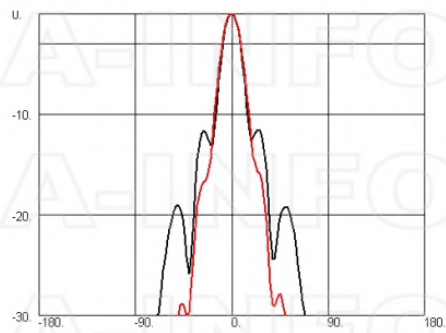

H-Plane — E-Plane —  
 3dB Beamwidth (deg): 17.56    3dB Beamwidth (deg): 16.32

Frequency: 28.0GHz

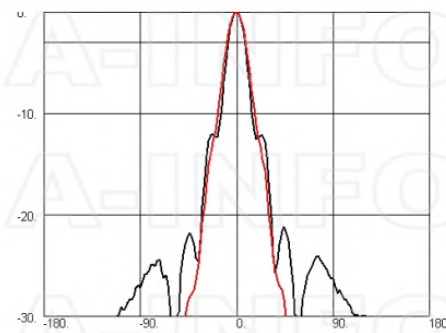

H-Plane — E-Plane —  
 3dB Beamwidth (deg): 17.63    3dB Beamwidth (deg): 15.78

Frequency: 30.0GHz

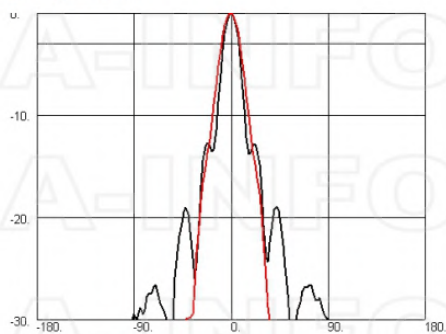

H-Plane — E-Plane —  
 3dB Beamwidth (deg): 17.29    3dB Beamwidth (deg): 13.99

Frequency: 32.0GHz

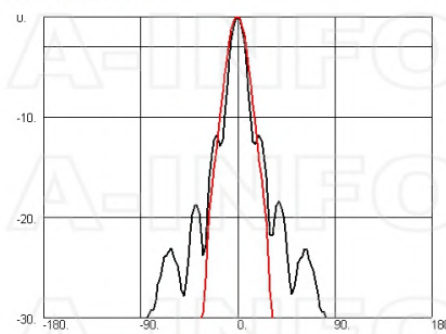

H-Plane — E-Plane —  
 3dB Beamwidth (deg): 16.51    3dB Beamwidth (deg): 13.05

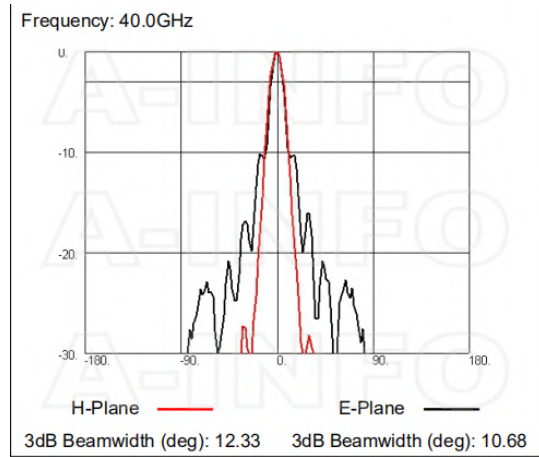
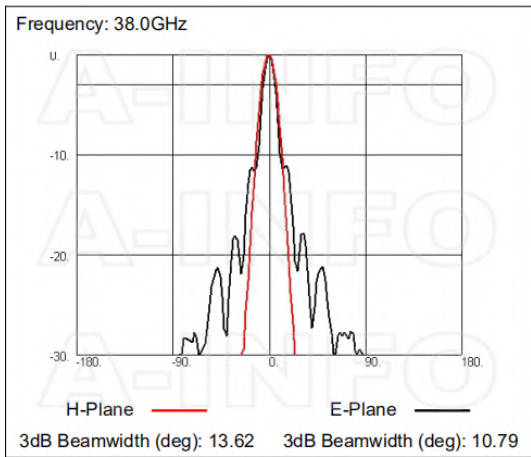
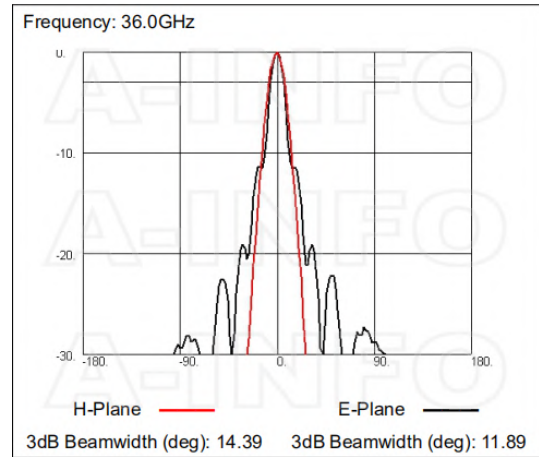
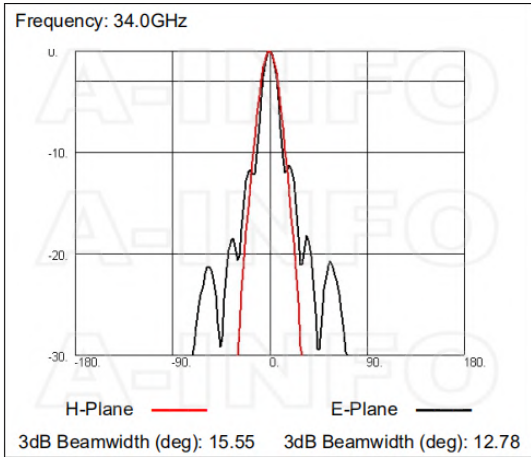

## Related Products



LB-19-25-MB2 Round Type Mounting Bracket



LB-19-25-L2 L type mounting bracket



LB-19-25-MA2 Stinger Type Mounting Bracket



Tripod\_15Kg Al Alloy Tripod



3033HL Wooden Tripod



3033QM Wooden Tripod  
Metalfree



Carrying Case\_LB-180400-20 Al  
Alloy Carrying Case



2.4M-2.4M-A050-500 Flexible  
Cable Assembly 500mm DC-  
40GHz 2.4mm Male to 2.4mm  
Male



2.4M-2.4M-A050-1000 Flexible  
Cable Assembly 1000mm DC-  
40GHz 2.4mm Male to 2.4mm  
Male



2.4M-2.4M-A050-1500 Flexible  
Cable Assembly 1500mm DC-  
40GHz 2.4mm Male to 2.4mm  
Male



2.4M-2.4M-A050-2000 Flexible  
Cable Assembly 2000mm DC-  
40GHz 2.4mm Male to 2.4mm  
Male



2.4M-2.4M-A050-3000 Flexible  
Cable Assembly 3000mm DC-  
40GHz 2.4mm Male to 2.4mm  
Male



2.4M-2.4M-A050-5000 Flexible  
Cable Assembly 5000mm DC-  
40GHz 2.4mm Male to 2.4mm  
Male



2.4M-2.4M-A050-10000 Flexible  
Cable Assembly 10000mm DC-  
40GHz 2.4mm Male to 2.4mm  
Male



2.4M-2.4M-B020-300 Flexible  
Cable Assembly 300mm DC-  
50GHz 2.4mm Male to 2.4mm  
Male

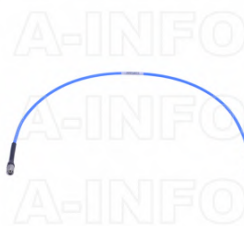

2.4M-2.4M-B020-500 Flexible  
Cable Assembly 500mm DC-  
50GHz 2.4mm Male to 2.4mm  
Male



2.4M-2.4M-B020-1000 Flexible  
Cable Assembly 1000mm DC-  
50GHz 2.4mm Male to 2.4mm  
Male



2.4M-2.4M-B020-1500 Flexible  
Cable Assembly 1500mm DC-  
50GHz 2.4mm Male to 2.4mm  
Male



2.4M-2.4M-B020-2000 Flexible  
Cable Assembly 2000mm DC-  
50GHz 2.4mm Male to 2.4mm  
Male



2.4M-2.4M-B020-3000 Flexible  
Cable Assembly 3000mm DC-  
50GHz 2.4mm Male to 2.4mm  
Male



2.4M-2.4M-B020-5000 Flexible Cable Assembly 5000mm DC-50GHz 2.4mm Male to 2.4mm Male



2.4M-2.4M-B020-10000 Flexible Cable Assembly 10000mm DC-50GHz 2.4mm Male to 2.4mm Male



2.4M-2.4F-B020S-500 Flexible Cable Assembly 500mm DC-50GHz 2.4mm Male to 2.4mm Female



2.4M-2.4F-B020S-1000 Flexible Cable Assembly 1000mm DC-50GHz 2.4mm Male to 2.4mm Female



2.4M-2.4F-B020S-1500 Flexible Cable Assembly 1500mm DC-50GHz 2.4mm Male to 2.4mm Female



2.4M-2.4F-B020S-2000 Flexible Cable Assembly 2000mm DC-50GHz 2.4mm Male to 2.4mm Female



2.4M-2.4F-B020S-3000 Flexible Cable Assembly 3000mm DC-50GHz 2.4mm Male to 2.4mm Female



2.4M-2.4F-B020S-5000 Flexible Cable Assembly 5000mm DC-50GHz 2.4mm Male to 2.4mm Female

### Similar Products



LB-180400-20-A Multi Octave Horn Antenna 18-40GHz 20dB Gain Double Ridge Waveguide Interface



LB-180400-20-ASPO Multi Octave Horn Antenna 18-40GHz 20dB Gain Double Ridge Waveguide Interface



LB-180400-20-C-KF Multi Octave Horn Antenna 18-40GHz 20dB Gain 2.92mm Female



LB-180400-20-C-KM Multi Octave Horn Antenna 18-40GHz 20dB Gain 2.92mm Male



LB-180400-20-C-KFSPO Multi Octave Horn Antenna 18-40GHz 20dB Gain 2.92mm Female



LB-180400-20-C-2.4FSPO Multi Octave Horn Antenna 18-40GHz 20dB Gain 2.4mm Female

### About this Datasheet

<ul style="list-style-type: none"> <li>● <b>Product Information</b></li> </ul> <p>Product Link:  <a href="https://www.ainfoinc.com/lb-180400-20-c-2-4f-multi-octave-horn-antenna-18-40-ghz-20db-gain-2-4mm-female">https://www.ainfoinc.com/lb-180400-20-c-2-4f-multi-octave-horn-antenna-18-40-ghz-20db-gain-2-4mm-female</a>            Data subject to change without notice.            © A-INFO INC. 2024. All Rights Reserved</p>	<ul style="list-style-type: none"> <li>● <b>Contact Us</b></li> </ul> <p>Address:            60 Tesla, Irvine, CA 92618, USA</p> <p>Website:  <a href="http://www.ainfoinc.com">www.ainfoinc.com</a></p> <p>Email:  <a href="mailto:sales@ainfoinc.com">sales@ainfoinc.com</a></p>	<ul style="list-style-type: none"> <li>● <b>Phone &amp; Fax</b></li> </ul> <p>Phone:            +1-949-639-9688            +1-949-639-9608</p> <p>Fax:            +1-949-639-9670</p>
---	--	---