



LB-180400-15-C-KM Multi Octave Horn Antenna 18-40GHz 15dB Gain
2.92mm Male

Multi Octave Horn Antenna Operating From 18GHz to 40GHz With a
Nominal 15dB Gain With 2.92mm Male Connector

Product Information

SKU	LB-180400-15-C-KM	Patents	ZL201630454584.X (China)
-----	-------------------	---------	--------------------------

Description

Multi octave horn antenna LB-180400-15-C-KM, operating from 18 to 40GHz with a nominal 15dB gain and low VSWR 1.5:1 with 2.92mm Male output connector. The model LB-180400-15-C-KM has uniform gain through its frequency span, providing efficient performance characteristics and directionality. It can handle 20W continuously and 40W peak power. Constructed of high thermal and electrical conductivity durable copper, the antenna will provide years of trouble-free indoor and outdoor service. This multi octave horn antenna is linearly polarized and ideally suited for EMI testing, direction finding, surveillance, antenna gain and pattern measurements and other applications.

Technical Specification

Electrical Specification		Interface	
Frequency, Min (GHz)	18	Output Type	Coaxial
Frequency, Max (GHz)	40	Connector	2.92mm(K)
Waveguide Type	Double Ridge	Connector Gender	Male
Waveguide Size EIA WRD	WRD180	Mechanical Specification	
Gain, Typ (dBi)	15	Figure	C Type
Polarization	Linear	Body Material	Cu
3dB Beamwidth, E-Plane, Min (Deg.)	21	Finish	Gold Plated, Gray Paint
3dB Beamwidth, E-Plane, Max (Deg.)	42	Size, W (mm)	32
3dB Beamwidth, H-Plane, Min (Deg.)	17	Size, H (mm)	28.6
3dB Beamwidth, H-Plane, Max (Deg.)	45	Size, L (mm)	71
Cross Pol. Isolation, Typ (dB)	35	Weight, (kg)	0.08
VSWR, Typ	1.5:1		
Impedance, (Ohm)	50		
Power Handling, CW, (W)	20		
Power Handling, Peak, (W)	40		

Additional Information

Application	General Purpose Indoor & Outdoor, Fixed	Solution for	Gain Reference Antenna Measurement Far-field Measurement System Intergration
-------------	---	--------------	---

Outline Drawing

2.92mm-Male Output (P/N: LB-180400-15-C-KM)

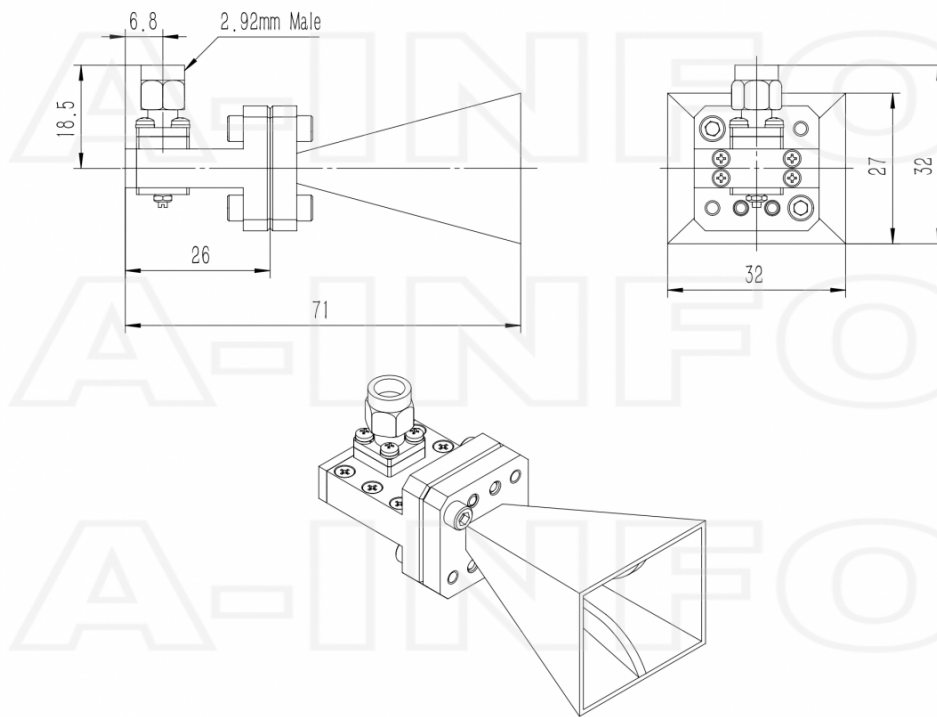

Typical Test Results

Gain

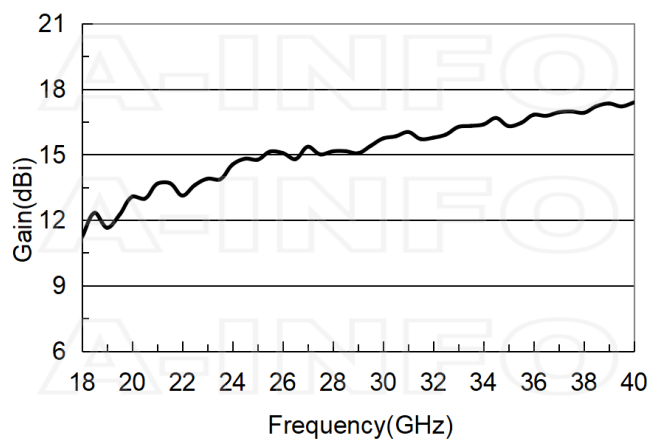

Antenna Factor

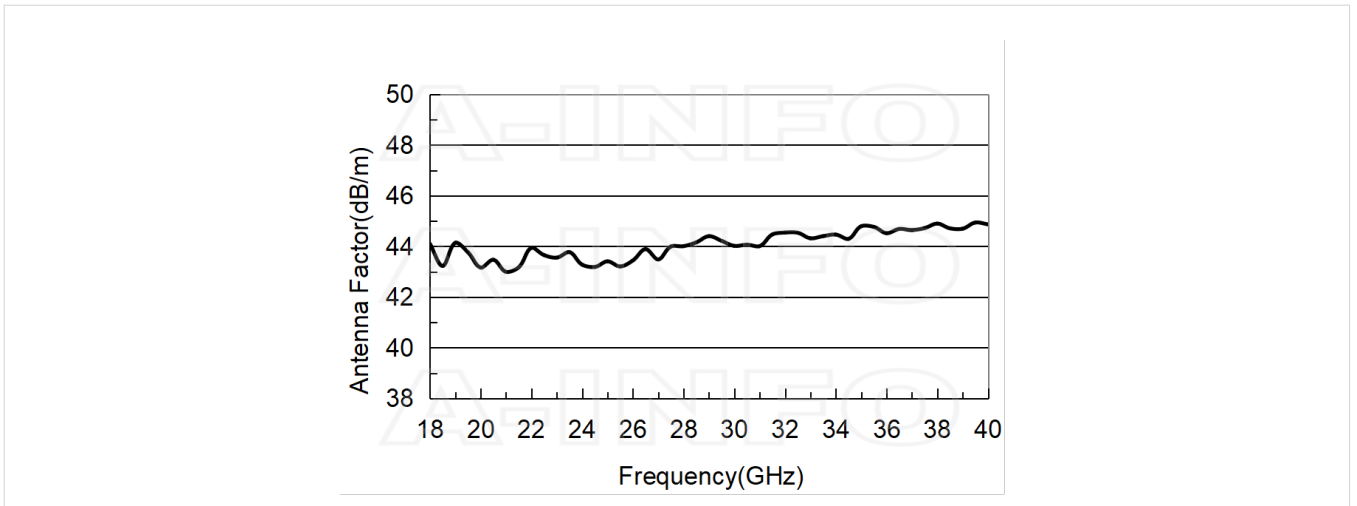

Antenna Factor (Table)

Frequency(GHz)	Gain(dBi)	Antenna Factor(dB/m)
18.0	11.22	44.10
20.0	13.07	43.16
22.0	13.12	43.94
24.0	14.54	43.28
26.0	15.07	43.44
28.0	15.14	44.01
30.0	15.73	44.02
32.0	15.77	44.55
34.0	16.38	44.46
36.0	16.82	44.52
38.0	16.91	44.90
40.0	17.38	44.87

Cross Polarization Isolation

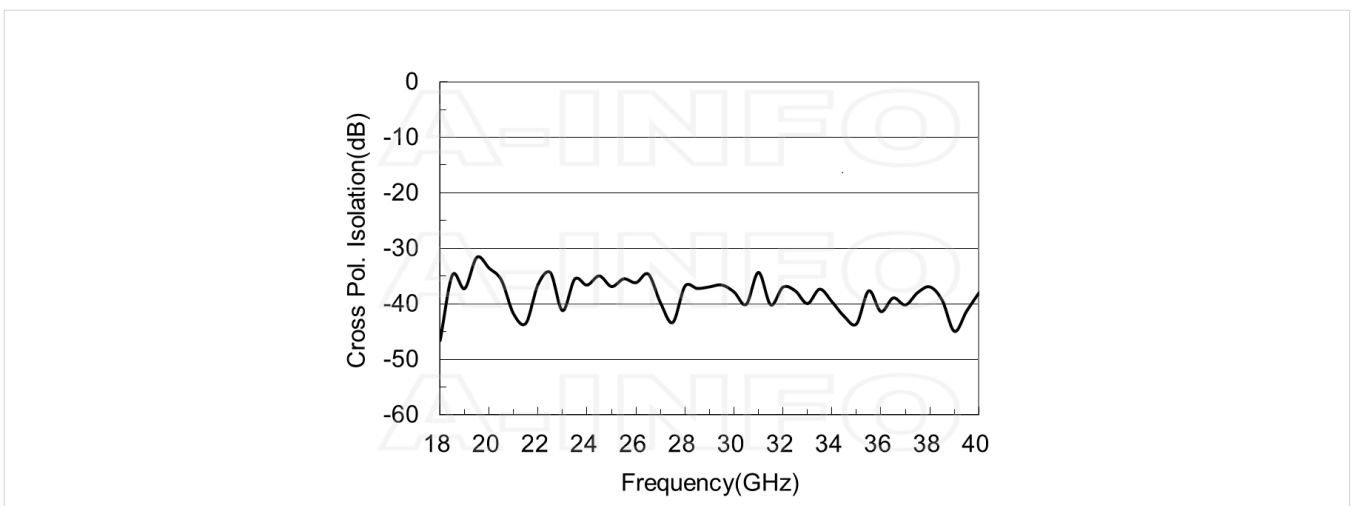

VSWR

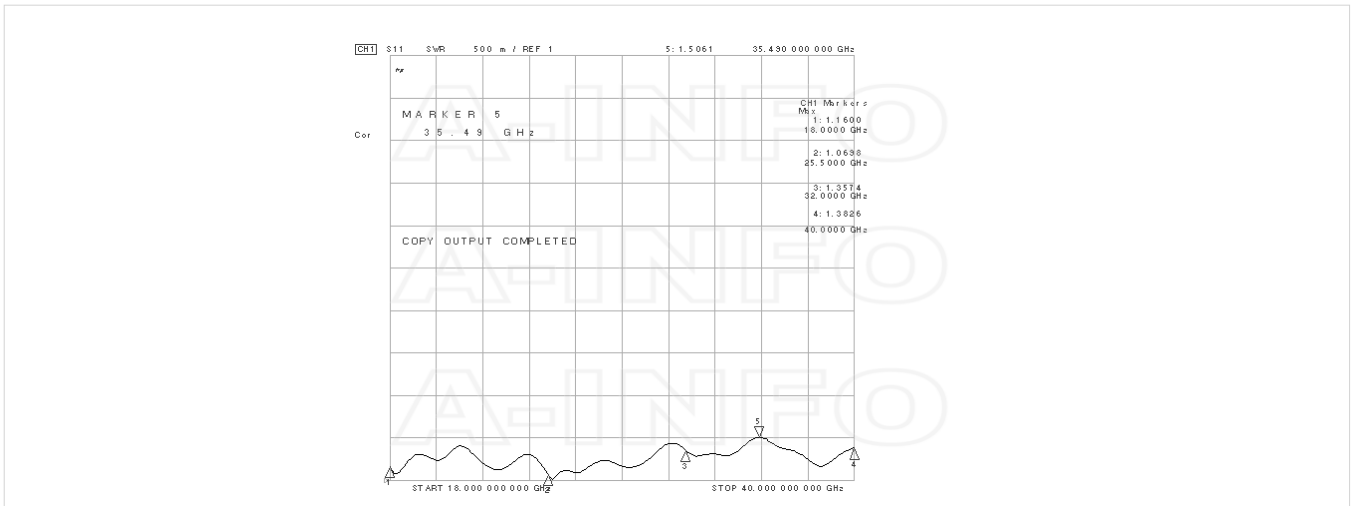

Beamwidth

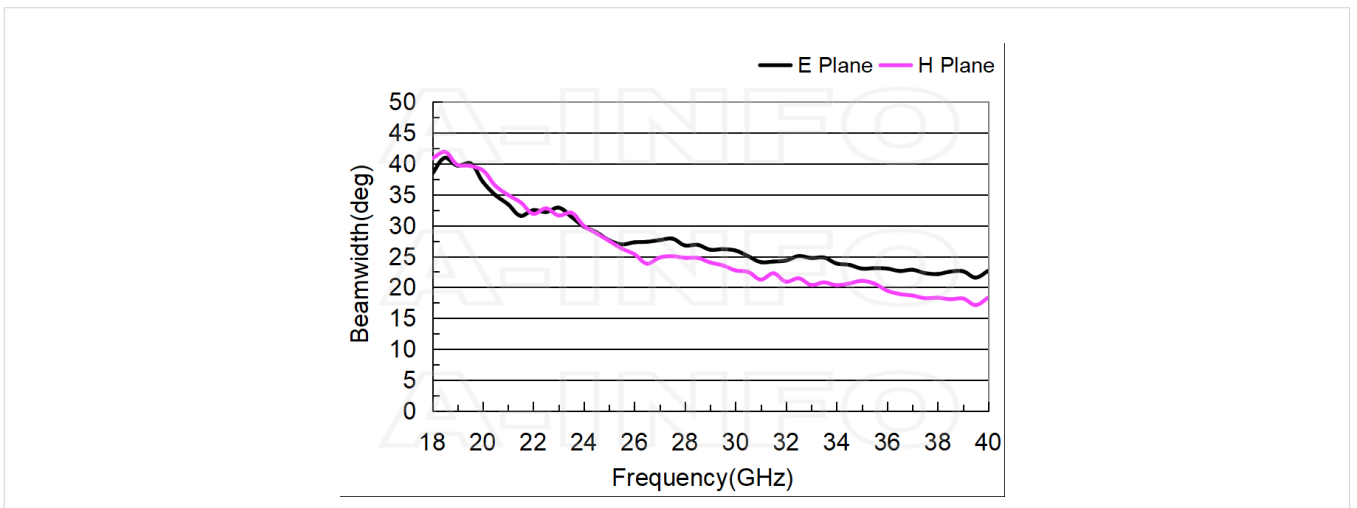

Pattern

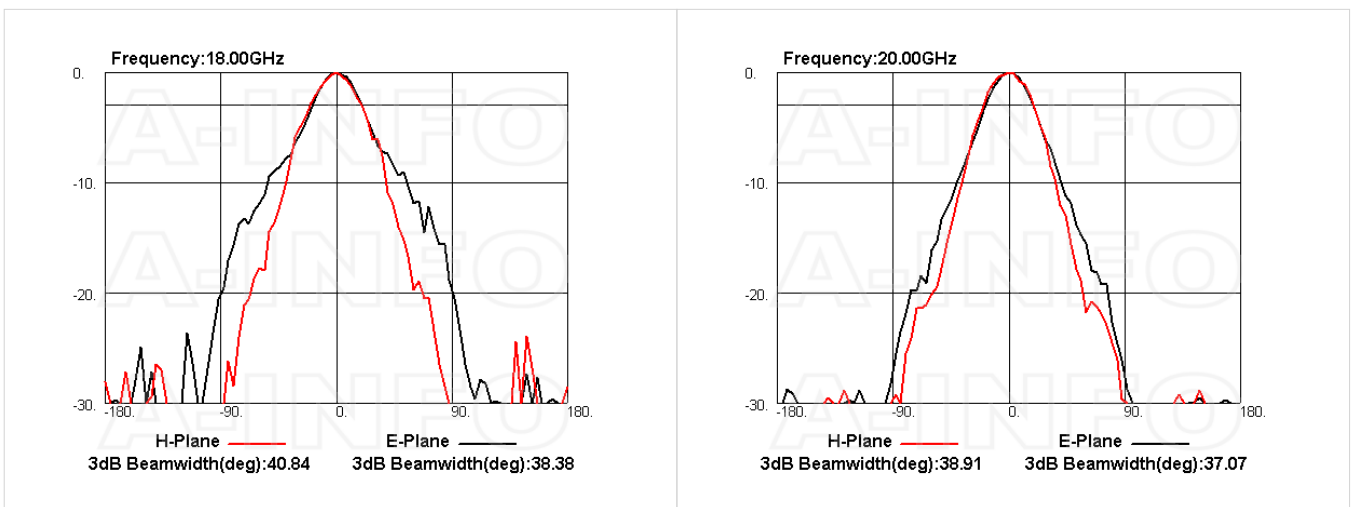

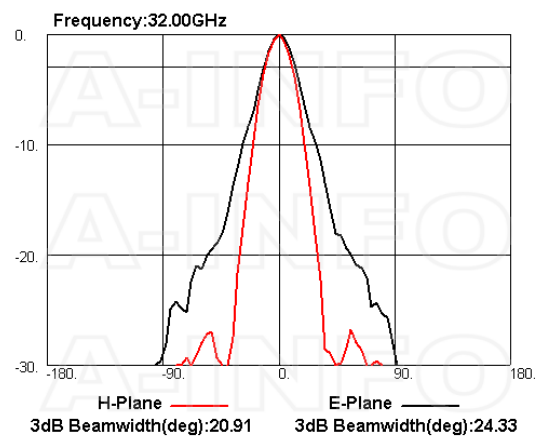
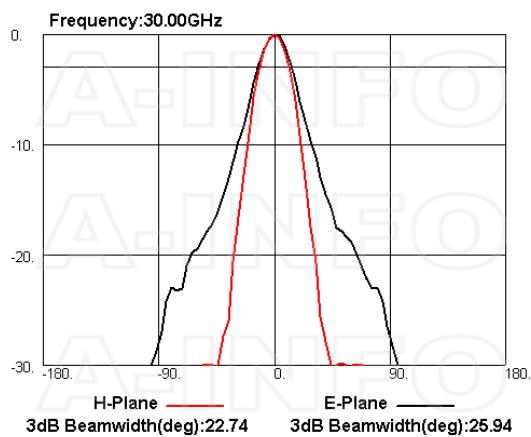
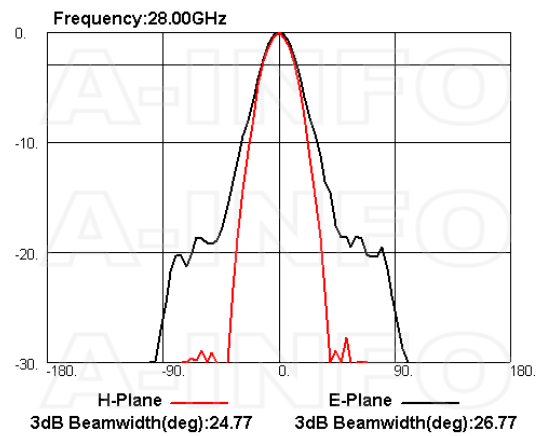
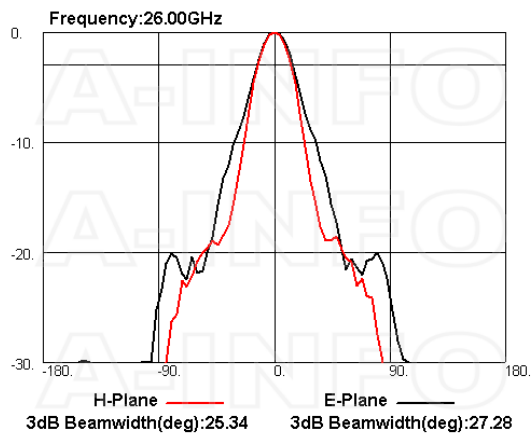
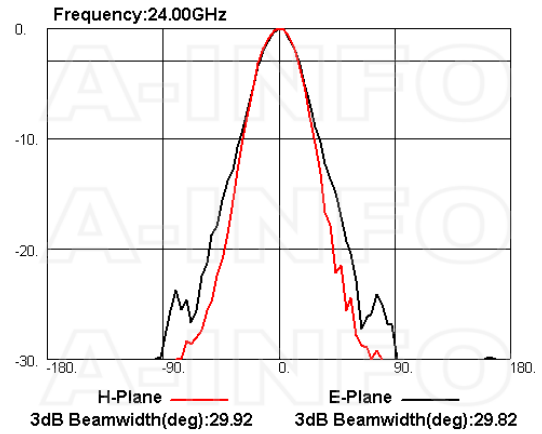
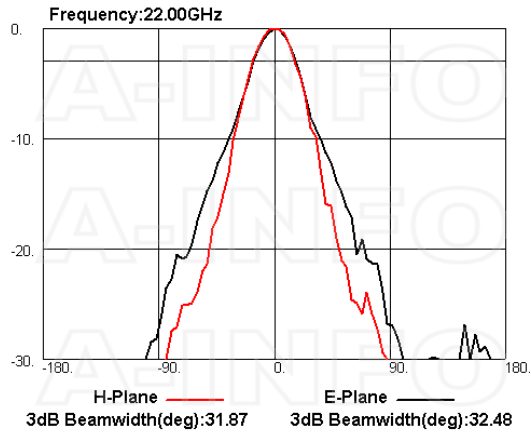

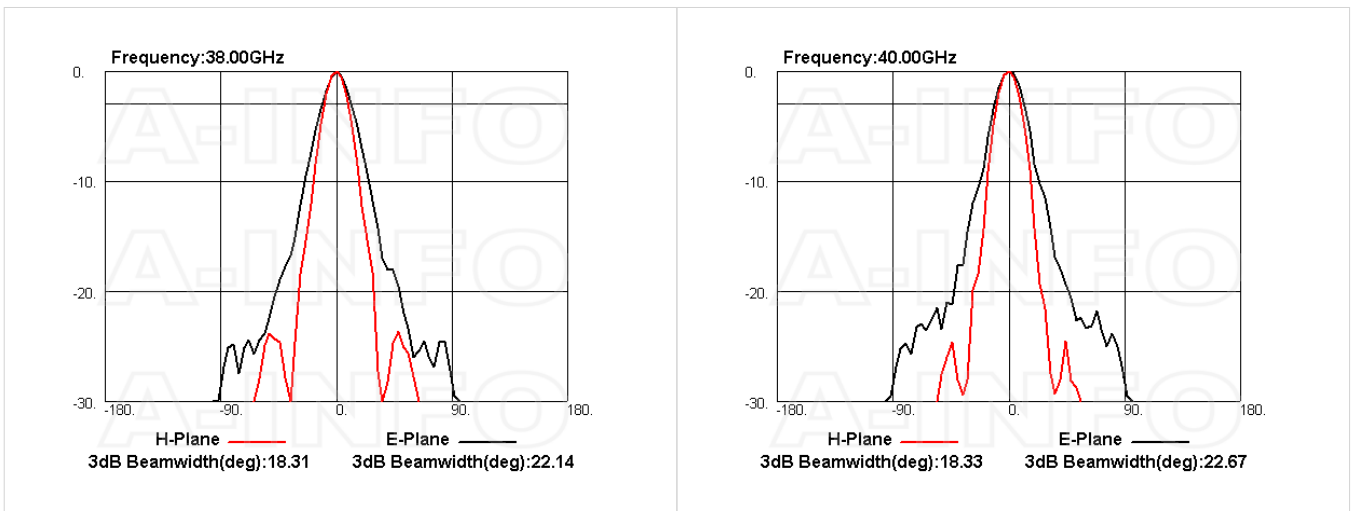
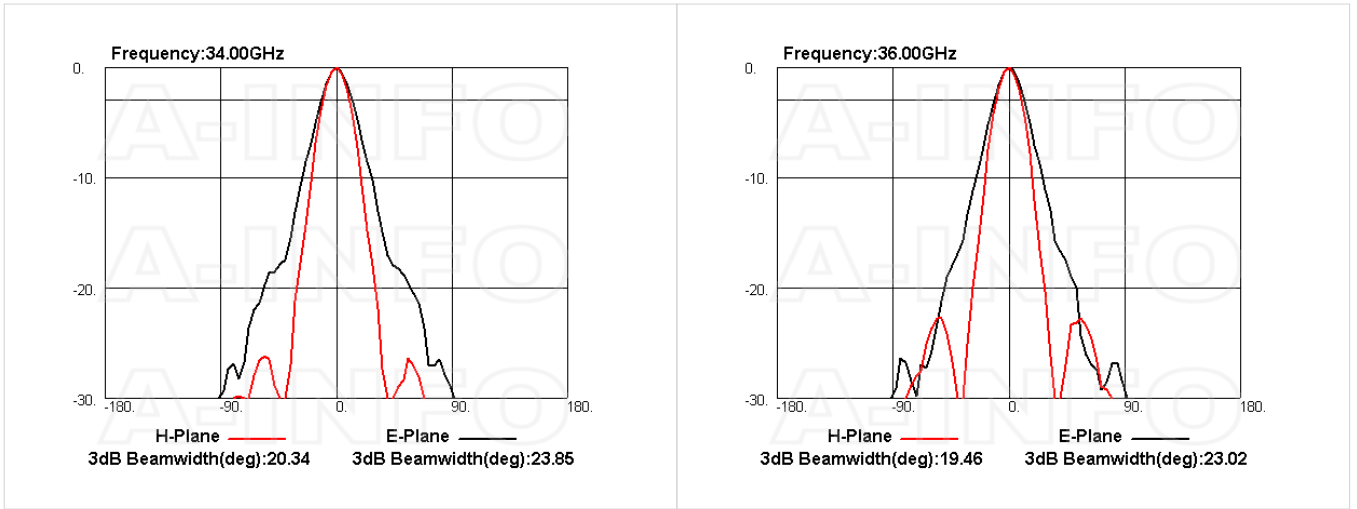

Related Products



LB-180400-10-C-MB Round Type Mounting Bracket



LB-180400-10-C-MBL L Type Mounting Bracket



Tripod_15Kg Al Alloy Tripod



3033HL Wooden Tripod



3033QM Wooden Tripod
Metalfree



Carrying Case_LB-180400-15 AI
Alloy Carrying Case



2.92M-2.92M-A050-500 Flexible
Cable Assembly 500mm DC-
40GHz 2.92mm Male to 2.92mm
Male



2.92M-2.92M-A050-1000 Flexible
Cable Assembly 1000mm DC-
40GHz 2.92mm Male to 2.92mm
Male



2.92M-2.92M-A050-1500 Flexible
Cable Assembly 1500mm DC-
40GHz 2.92mm Male to 2.92mm
Male



2.92M-2.92M-A050-2000 Flexible
Cable Assembly 2000mm DC-
40GHz 2.92mm Male to 2.92mm
Male



2.92M-2.92M-A050-3000 Flexible
Cable Assembly 3000mm DC-
40GHz 2.92mm Male to 2.92mm
Male



2.92M-2.92M-A050-5000 Flexible
Cable Assembly 5000mm DC-
40GHz 2.92mm Male to 2.92mm
Male



2.92M-2.92M-A050-10000
Flexible Cable Assembly
10000mm DC- 40GHz 2.92mm
Male to 2.92mm Male

Similar Products



LB-180400-15-A Multi Octave
Horn Antenna 18-40GHz 15dB
Gain Double Ridge Waveguide
Interface

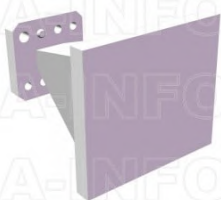

LB-180400-15-ASPO Multi Octave
Horn Antenna 18-40GHz 15dB
Gain Double Ridge Waveguide
Interface



LB-180400-15-C-KF Multi Octave
Horn Antenna 18-40GHz 15dB
Gain 2.92mm Female

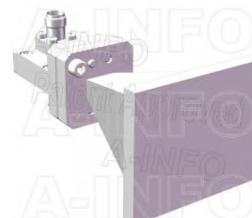

LB-180400-15-C-KFSPO Multi
Octave Horn Antenna 18-40GHz
15dB Gain 2.92mm Female



LB-180400-15-C-2.4F Multi
Octave Horn Antenna 18-40GHz
15dB Gain 2.4mm Female



LB-180400-15-C-2.4FSPO Multi
Octave Horn Antenna 18-40GHz
15dB Gain 2.4mm Female

About this Datasheet

<ul style="list-style-type: none"> ● Product Information Product Link: https://www.ainfoinc.com/lb-180400-15-c-km-multi-octave-horn-antenna-18-40-ghz-15db-gain-2-92mm-male Data subject to change without notice. © A-INFO INC. 2024. All Rights Reserved 	<ul style="list-style-type: none"> ● Contact Us Address: 60 Tesla, Irvine, CA 92618, USA Website: www.ainfoinc.com Email: sales@ainfoinc.com 	<ul style="list-style-type: none"> ● Phone & Fax Phone: +1-949-639-9688 +1-949-639-9608 Fax: +1-949-639-9670
---	--	---