

LB-180400-10-ASPO Multi Octave Horn Antenna 18-40GHz 10dB Gain Double Ridge Waveguide Interface

Multi Octave Horn Antenna From 18GHz to 40GHz With a Nominal 10dB Gain With Double Ridge Waveguide Interface

Product Information

SKU	LB-180400-10-ASPO
-----	-------------------

Description

Multi octave horn antenna LB-180400-10-ASPO, operating from 18 to 40GHz with a nominal 10dB gain and low VSWR 1.5:1 with FPWRD180C24 output. The model LB-180400-10-ASPO has uniform gain through its frequency span, providing efficient performance characteristics and directionality. Constructed of high thermal and electrical conductivity durable copper, the horn comes with a specially designed weatherproof radome which provides excellent protection against the rain and dust but has very little loss across the full operating frequency band. This multi octave horn antenna is linearly polarized and ideally suited for EMI testing, direction finding, surveillance, antenna gain and pattern measurements and other applications.

Technical Specification

Electrical Specification		Interface	
Frequency, Min (GHz)	18	Output Type	Waveguide
Frequency, Max (GHz)	40	Flange Designation, WRD	FPWRD180C24
Waveguide Type	Double Ridge	Connector Gender	N/A
Waveguide Size EIA WRD	WRD180	Mechanical Specification	
Gain, Typ (dBi)	10	Figure	A Type
Polarization	Linear	Body Material	Cu
3dB Beamwidth, E-Plane, Min (Deg.)	27	Finish	Gold Plated, Gray Paint
3dB Beamwidth, E-Plane, Max (Deg.)	54	Size, W (mm)	26
3dB Beamwidth, H-Plane, Min (Deg.)	28	Size, H (mm)	23
3dB Beamwidth, H-Plane, Max (Deg.)	52	Size, L (mm)	31.8
Cross Pol. Isolation, Typ (dB)	40	Weight, (kg)	0.05
VSWR, Typ	1.5:1		

Additional Information

Application	Outdoor, Waterproof and Dustproof, Fixed	Solution for	Gain Reference Antenna Measurement Far-field Measurement System Intergration
-------------	--	--------------	---

Outline Drawing

FPWRD180C24 Output with Radome (Option, P/N: LB-180400-10-ASPO, Outdoor Application)

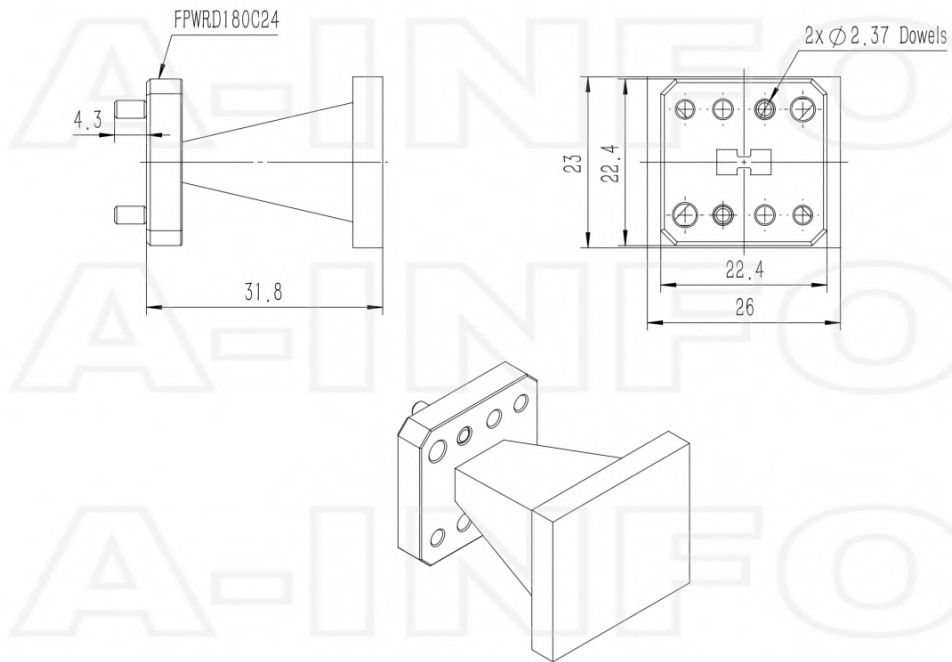

Flange Drawing

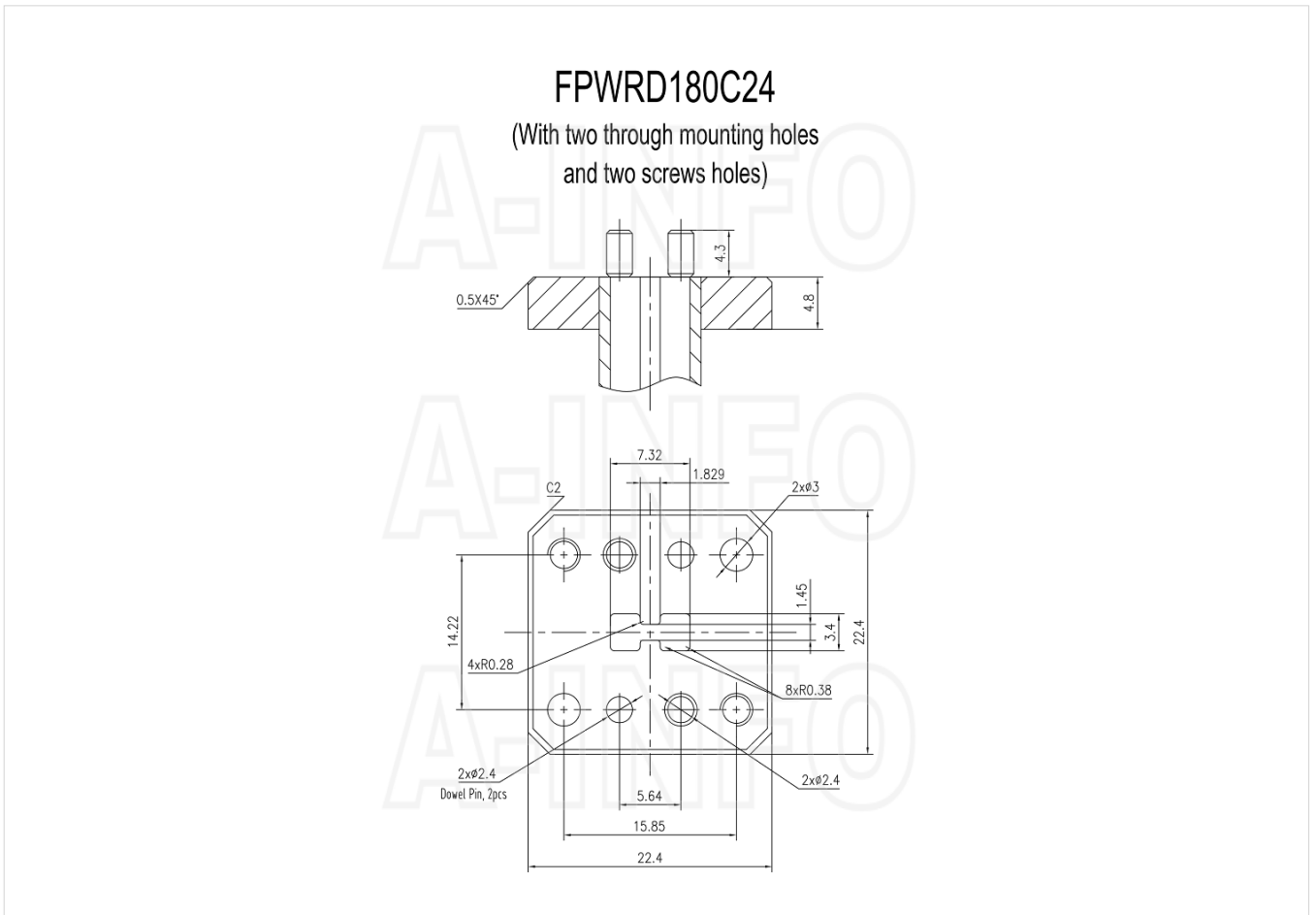

Typical Test Results

Gain

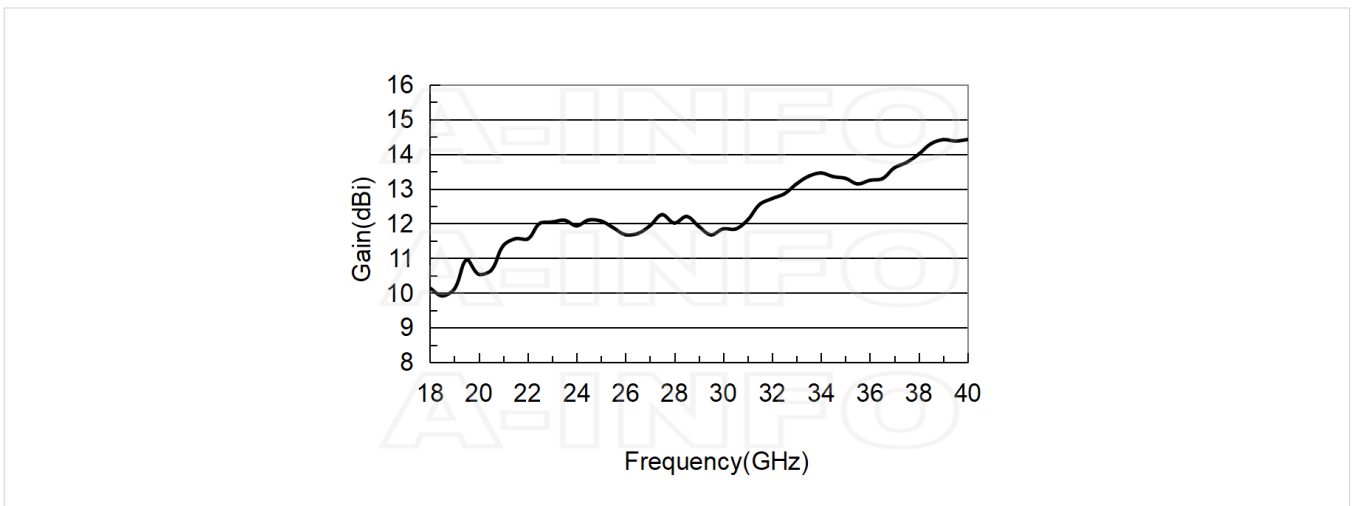

Antenna Factor

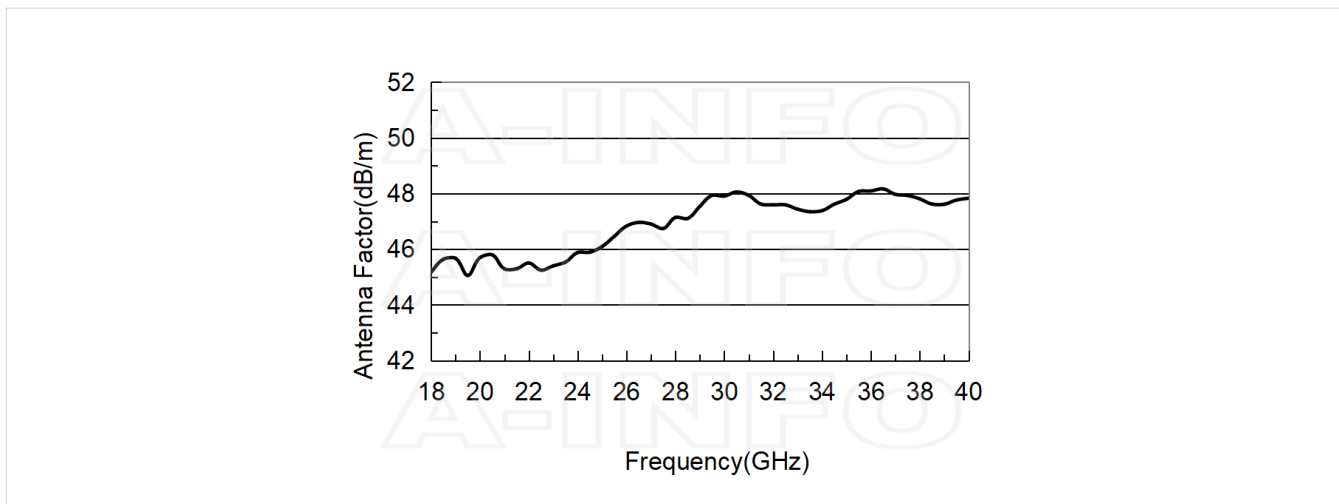

Antenna Factor (Table)

Frequency(GHz)	Gain(dBi)	Antenna Factor(dB/m)
18.0	10.14	45.17
20.0	10.54	45.70
22.0	11.55	45.51
24.0	11.93	45.88
26.0	11.68	46.83
28.0	12.01	47.14
30.0	11.84	47.91
32.0	12.72	47.59
34.0	13.45	47.39
36.0	13.24	48.09
38.0	14.00	47.81
40.0	14.42	47.83

Cross Polarization Isolation

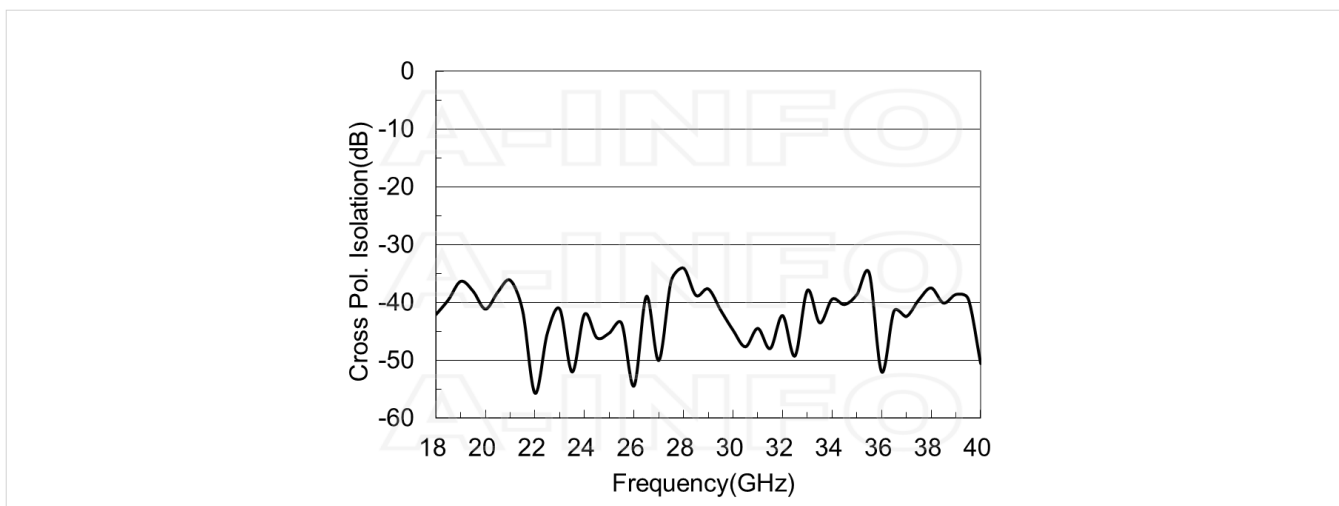

VSWR

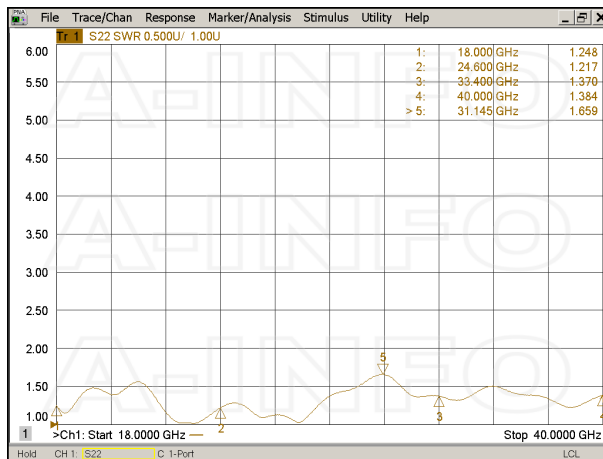

Beamwidth

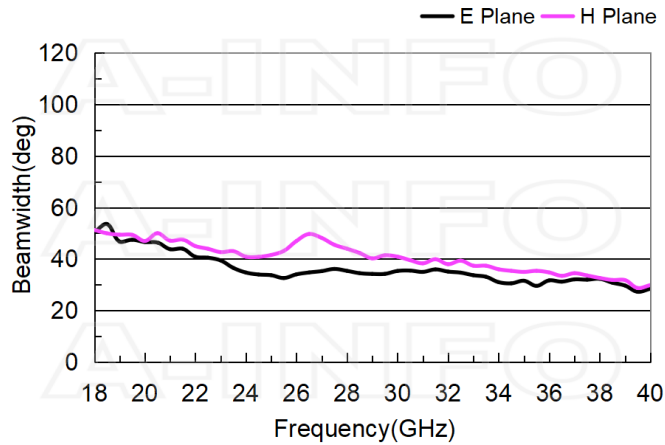

Pattern

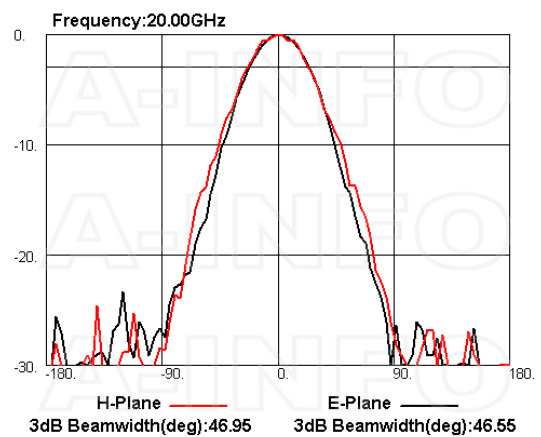
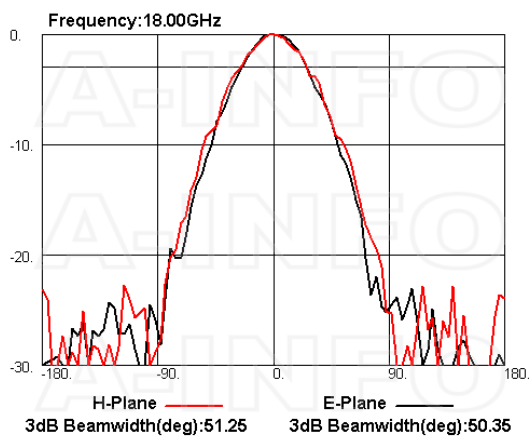

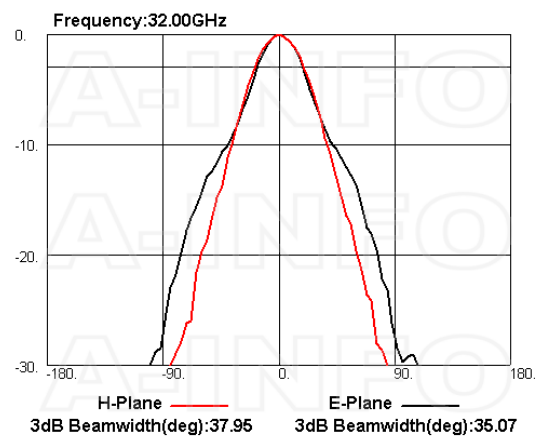
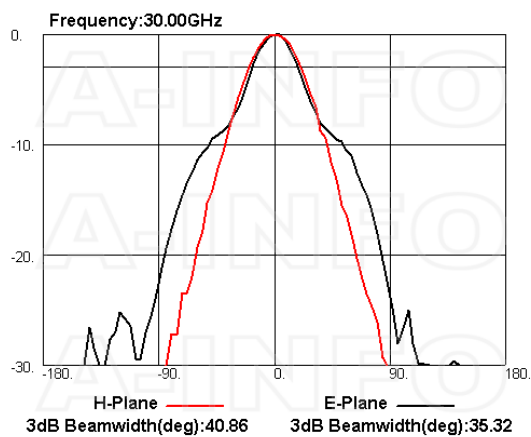
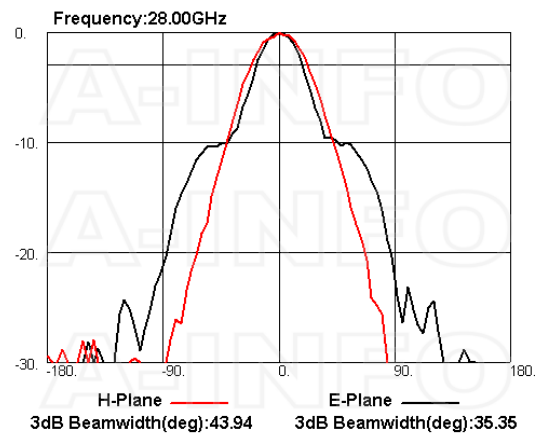
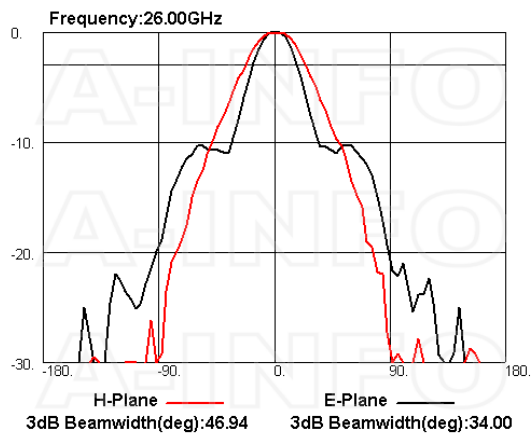
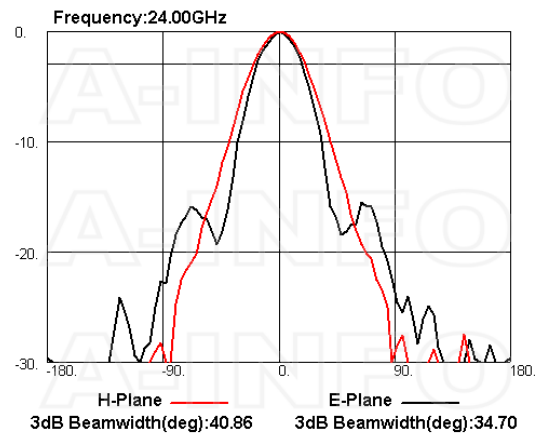
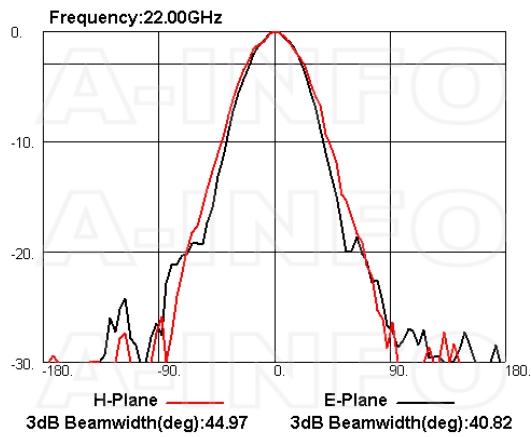

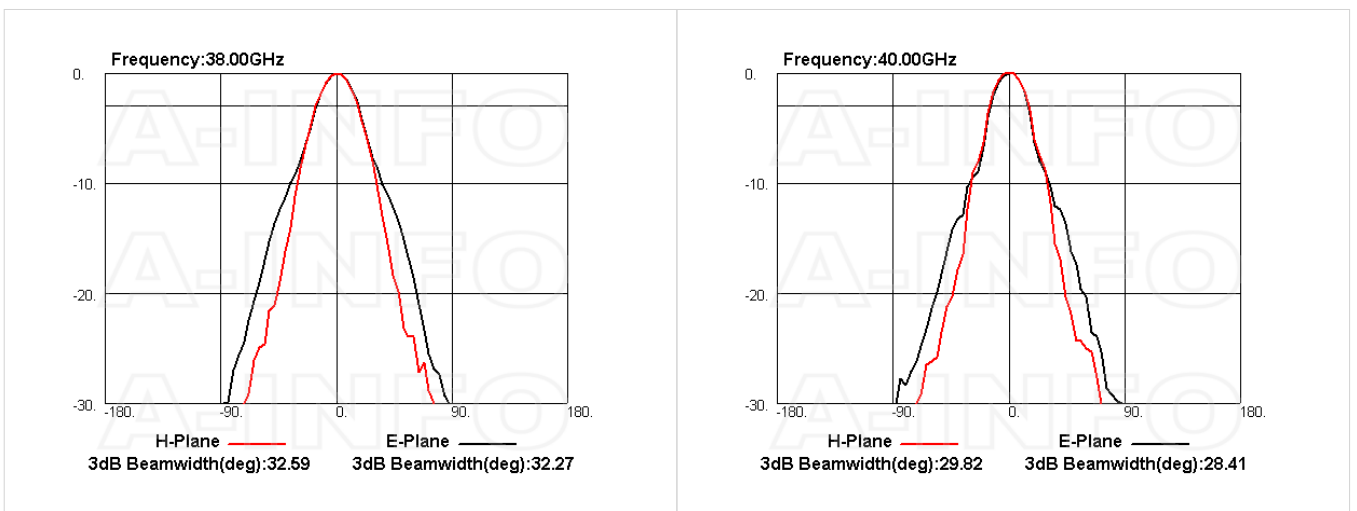
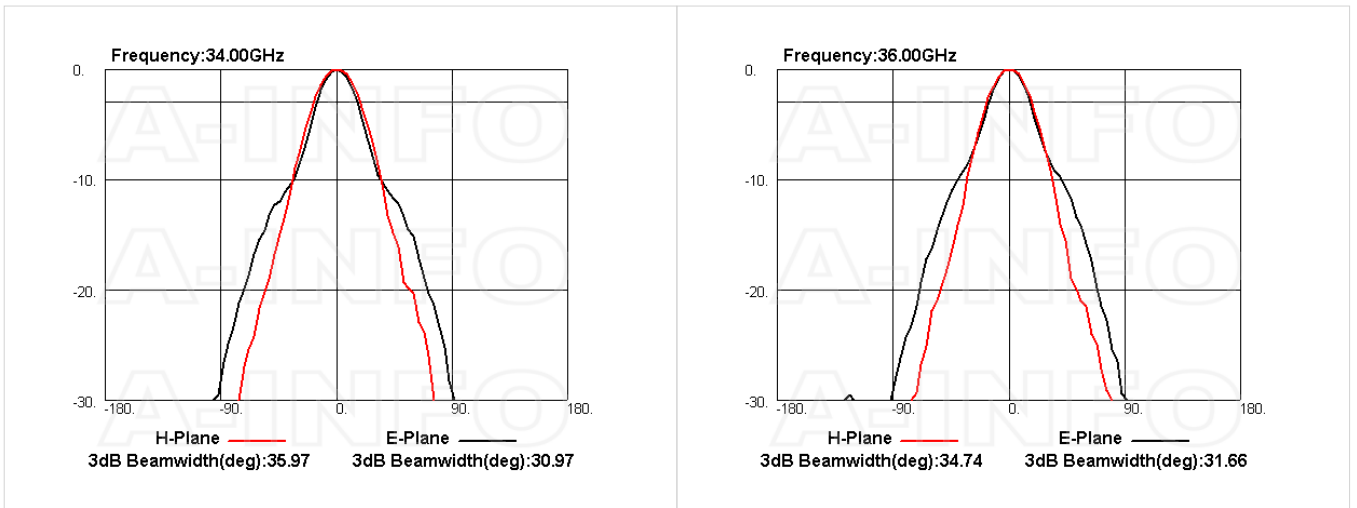

Related Products



180DRWCAK_Cu Right Angle Double Ridge Waveguide to Coaxial Adapter 18-40GHz WRD180 to 2.92mm Female



180DRWCA2.4_Cu Right Angle Double Ridge Waveguide to Coaxial Adapter 18-40GHz WRD180 to 2.4mm Female



180DRWECAK_Cu Endlaunch Double Ridge Waveguide to Coaxial Adapter 18-40GHz WRD180 to 2.92mm Female



180DRWECA2.4_Cu Endlaunch Double Ridge Waveguide to Coaxial Adapter 18-40GHz WRD180 to 2.4mm Female



LB-180400-10-C-MB Round Type Mounting Bracket



LB-180400-10-C-MBL L Type Mounting Bracket



Tripod_15Kg Al Alloy Tripod



3033HL Wooden Tripod



3033QM Wooden Tripod Metalfree

Similar Products



LB-180400-10-A Multi Octave Horn Antenna 18-40GHz 10dB Gain Double Ridge Waveguide Interface



LB-180400-10-C-KF Multi Octave Horn Antenna 18-40GHz 10dB Gain 2.92mm Female



LB-180400-10-C-KM Multi Octave Horn Antenna 18-40GHz 10dB Gain 2.92mm Male



LB-180400-10-C-KFSPO Multi Octave Horn Antenna 18-40GHz 10dB Gain 2.92mm Female



LB-180400-10-C-2.4F Multi Octave Horn Antenna 18-40GHz 10dB Gain 2.4mm Female



LB-180400-10-C-2.4FSPO Multi Octave Horn Antenna 18-40GHz 10dB Gain 2.4mm Female

About this Datasheet

<ul style="list-style-type: none"> ● Product Information Product Link: https://www.ainfoinc.com/lb-180400-10-aspo-multi-octave-horn-antenna-18-40-ghz-10db-gain-fpwr180c24 Data subject to change without notice. © A-INFO INC. 2024. All Rights Reserved 	<ul style="list-style-type: none"> ● Contact Us Address: 60 Tesla, Irvine, CA 92618, USA Website: www.ainfoinc.com Email: sales@ainfoinc.com 	<ul style="list-style-type: none"> ● Phone & Fax Phone: +1-949-639-9688 +1-949-639-9608 Fax: +1-949-639-9670
---	---	--