



LB-110265-20-C-SF Multi Octave Horn Antenna 11-26.5GHz 20dB Gain SMA Female

Multi Octave Horn Antenna Operating From 11GHz to 26.5GHz With a Nominal 20dB Gain With SMA Female Connector

### Product Information

SKU	LB-110265-20-C-SF
-----	-------------------

### Description

Multi octave horn antenna LB-110265-20-C-SF, operating from 11 to 26.5GHz with a nominal 20dB gain and low VSWR 1.5:1 with SMA Female output connector. The model LB-110265-20-C-SF has uniform gain through its frequency span, providing efficient performance characteristics and directionality. It can handle 50W continuously and 1000W peak power. Constructed of lightweight corrosion-resistant aluminum, the antenna will provide years of trouble-free indoor and outdoor service. This multi octave horn antenna is linearly polarized and ideally suited for EMI testing, direction finding, surveillance, antenna gain and pattern measurements and other applications.

## Technical Specification

Electrical Specification		Interface	
Frequency, Min (GHz)	11	Output Type	Coaxial
Frequency, Max (GHz)	26.5	Connector	SMA
Waveguide Type	Double Ridge	Connector Gender	Female
Waveguide Size EIA WRD	WRD110	Mechanical Specification	
Gain, Typ (dBi)	20	Figure	C Type
Polarization	Linear	Body Material	Al
3dB Beamwidth, E-Plane, Min (Deg.)	9	Finish	Gold Plated and Chemical Conversion Coating, Gray Paint
3dB Beamwidth, E-Plane, Max (Deg.)	23	Size, W (mm)	75.1
3dB Beamwidth, H-Plane, Min (Deg.)	10	Size, H (mm)	70
3dB Beamwidth, H-Plane, Max (Deg.)	26	Size, L (mm)	163
Cross Pol. Isolation, Typ (dB)	40	Weight, (kg)	0.24
VSWR, Typ	1.5:1		
Impedance, (Ohm)	50		
Power Handling, CW, (W)	50		
Power Handling, Peak, (W)	1000		

## Additional Information

Application	General Purpose Indoor & Outdoor, Fixed	Solution for	Gain Reference Antenna Measurement Far-field Measurement System Intergration
-------------	---	--------------	---

## Outline Drawing

SMA-Female Output (P/N: LB-110265-20-C-SF)

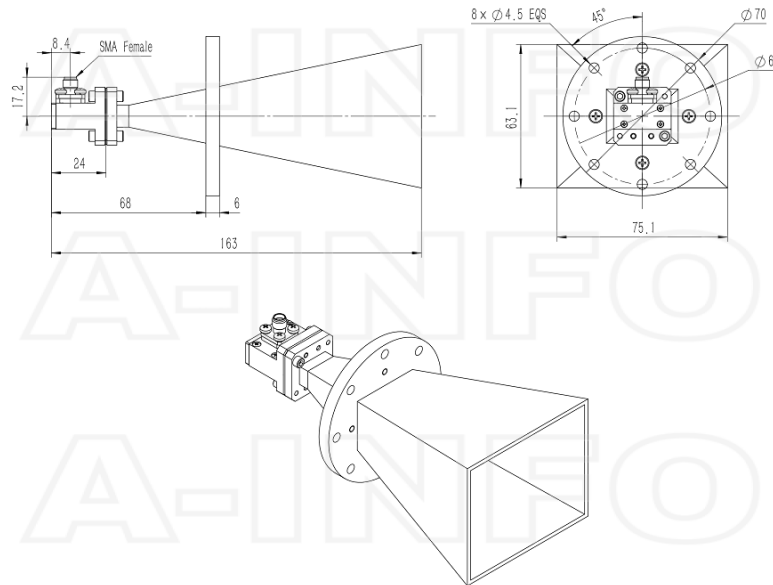

## Typical Test Results

Gain

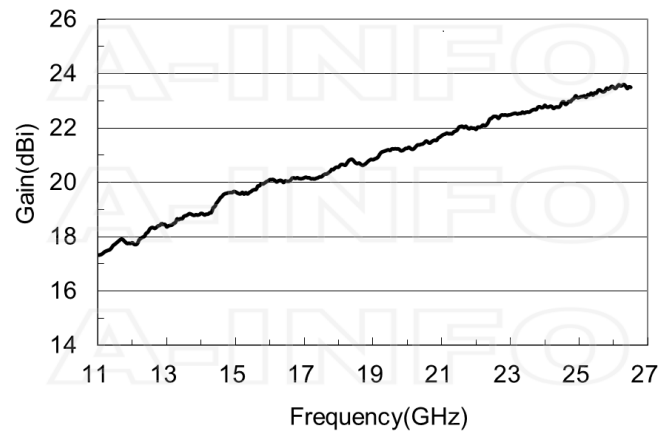

## Antenna Factor

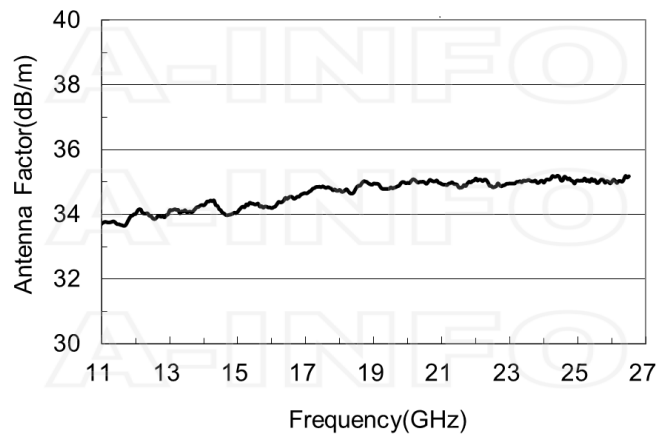

## Antenna Factor (Table)

Frequency(GHz)	Gain(dBi)	AF(dB/m)
11.0	17.32	33.72
12.0	17.78	34.01
13.0	18.36	34.13
14.0	18.86	34.27
15.0	19.65	34.08
16.0	20.10	34.19
17.0	20.17	34.65
18.0	20.56	34.76
19.0	20.83	34.96
20.0	21.25	34.98
21.0	21.72	34.93
22.0	21.95	35.11
23.0	22.49	34.96
24.0	22.84	34.98
25.0	23.12	35.05
26.0	23.50	35.01
26.5	23.50	35.18

## Cross Polarization Isolation

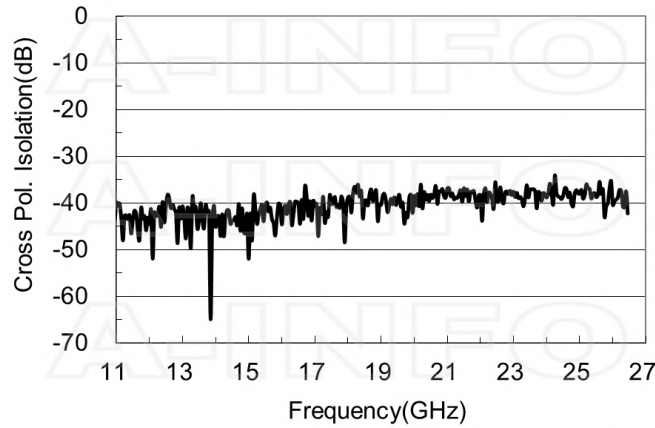

## VSWR

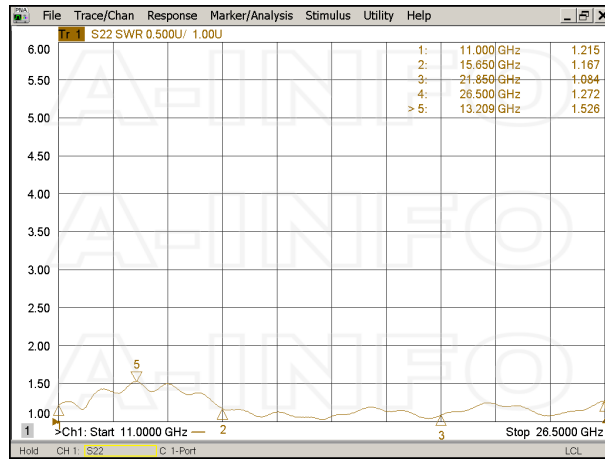

## Pattern

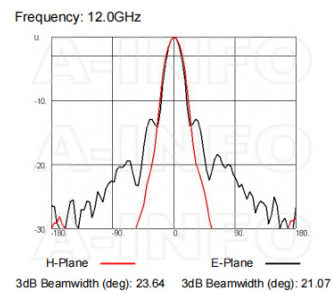
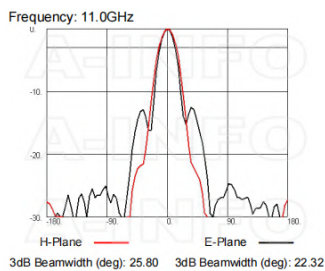

Frequency: 13.0GHz

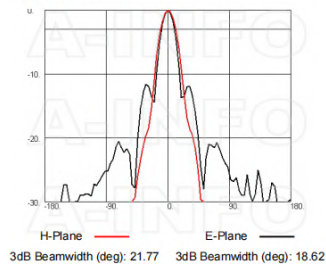

Frequency: 14.0GHz

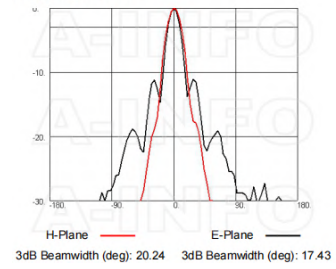

Frequency: 15.0GHz

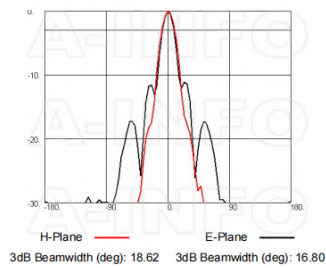

Frequency: 16.0GHz

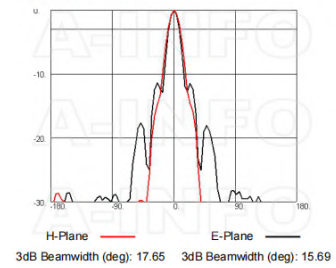

Frequency: 17.0GHz

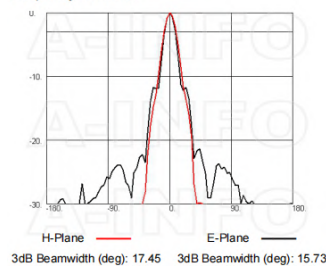

Frequency: 18.0GHz

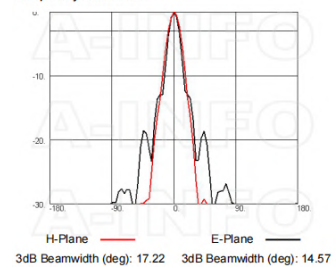

Frequency: 19.0GHz

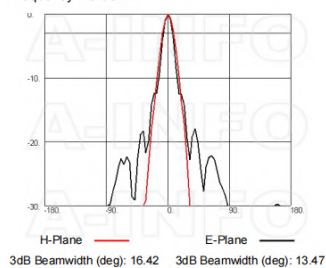

Frequency: 20.0GHz

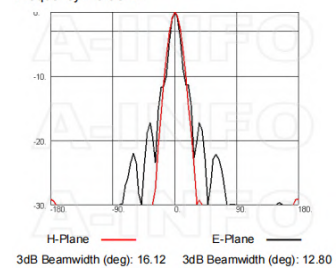

Frequency: 21.0GHz

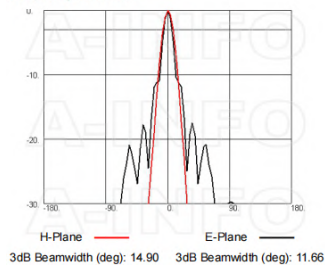

Frequency: 22.0GHz

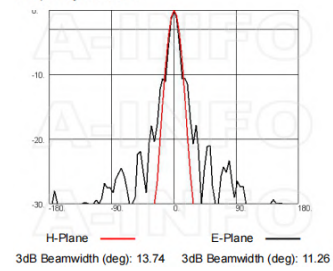

Frequency: 23.0GHz

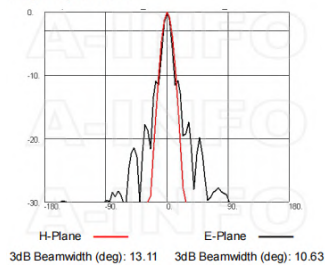

Frequency: 24.0GHz

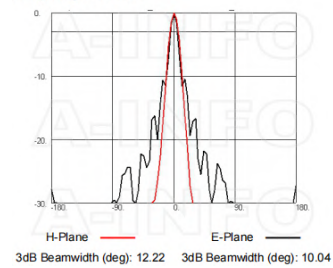

Frequency: 25.0GHz

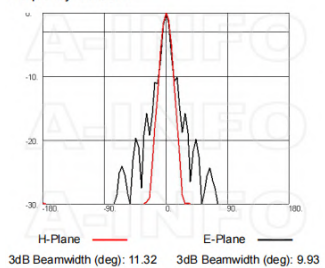

Frequency: 26.0GHz

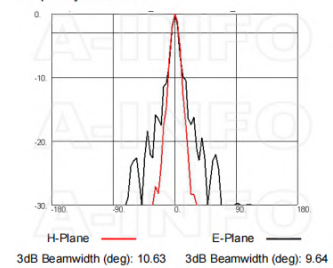

Frequency: 26.5GHz

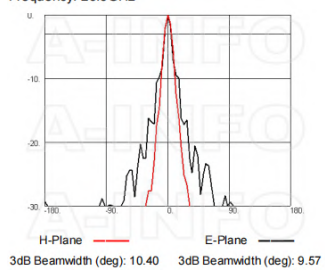

## Related Products



Carrying Case\_LB-110265-20-C AI Alloy Carrying Case



SM-SM-A050-1000 Flexible Cable Assembly 1000mm DC- 26.5GHz SMA Male to SMA Male



SM-SM-A050-1500 Flexible Cable Assembly 1500mm DC- 26.5GHz SMA Male to SMA Male



SM-SM-A050-2000 Flexible Cable Assembly 2000mm DC- 26.5GHz SMA Male to SMA Male



SM-SM-A050-3000 Flexible Cable Assembly 3000mm DC- 26.5GHz SMA Male to SMA Male



SM-SM-A050-5000 Flexible Cable Assembly 5000mm DC- 26.5GHz SMA Male to SMA Male



SM-SM-A050-10000 Flexible Cable Assembly 10000mm DC- 26.5GHz SMA Male to SMA Male



SM-SM-A080-1000 Flexible Cable Assembly 1000mm DC- 26.5GHz SMA Male to SMA Male



SM-SM-A080-1500 Flexible Cable Assembly 1500mm DC- 26.5GHz SMA Male to SMA Male



SM-SM-A080-2000 Flexible Cable Assembly 2000mm DC- 26.5GHz SMA Male to SMA Male



SM-SM-A080-3000 Flexible Cable Assembly 3000mm DC- 26.5GHz SMA Male to SMA Male



SM-SM-A080-5000 Flexible Cable Assembly 5000mm DC- 26.5GHz SMA Male to SMA Male



SM-SM-A080-10000 Flexible Cable Assembly 10000mm DC- 26.5GHz SMA Male to SMA Male



SM-SM-A080-20000 Flexible Cable Assembly 20000mm DC- 26.5GHz SMA Male to SMA Male

## Similar Products



LB-110265-20-A Multi Octave Horn Antenna 11-26.5GHz 20dB Gain Double Ridge Waveguide Interface

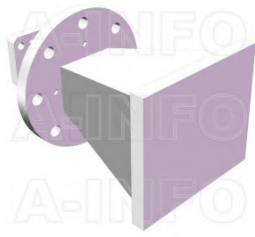

LB-110265-20-ASPO Multi Octave Horn Antenna 11-26.5GHz 10dB Gain Double Ridge Waveguide Interface

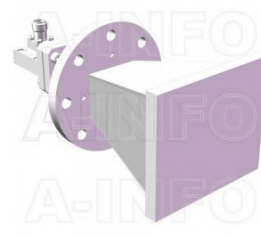

LB-110265-20-C-SFSP0 Multi Octave Horn Antenna 11-26.5GHz 20dB Gain SMA Female

## About this Datasheet

<ul style="list-style-type: none"> <li>● <b>Product Information</b></li> </ul> <p>Product Link:  <a href="https://www.ainfoinc.com/lb-110265-20-c-sf-multi-octave-horn-antenna-11-26-5-ghz-20db-gain-sma-female">https://www.ainfoinc.com/lb-110265-20-c-sf-multi-octave-horn-antenna-11-26-5-ghz-20db-gain-sma-female</a>              Data subject to change without notice.              © A-INFO INC. 2024. All Rights Reserved</p>	<ul style="list-style-type: none"> <li>● <b>Contact Us</b></li> </ul> <p>Address:              60 Tesla, Irvine, CA 92618, USA</p> <p>Website:  <a href="http://www.ainfoinc.com">www.ainfoinc.com</a></p> <p>Email:  <a href="mailto:sales@ainfoinc.com">sales@ainfoinc.com</a></p>	<ul style="list-style-type: none"> <li>● <b>Phone &amp; Fax</b></li> </ul> <p>Phone:              +1-949-639-9688              +1-949-639-9608</p> <p>Fax:              +1-949-639-9670</p>
---	--	---