



LB-110265-15-A Multi Octave Horn Antenna 11-26.5GHz 15dB Gain Double Ridge Waveguide Interface

Multi Octave Horn Antenna From 11GHz to 26.5GHz With a Nominal 15dB Gain With Double Ridge Waveguide Interface

Product Information

SKU	LB-110265-15-A
-----	----------------

Description

Multi octave horn antenna LB-110265-15-A, operating from 11 to 26.5GHz with a nominal 15dB gain and low VSWR 1.5:1 with FPWRD110C24 output. The model LB-110265-15-A has uniform gain through its frequency span, providing efficient performance characteristics and directionality. Constructed of lightweight corrosion-resistant aluminum, the antenna will provide years of trouble-free indoor and outdoor service. This multi octave horn antenna is linearly polarized and ideally suited for EMI testing, direction finding, surveillance, antenna gain and pattern measurements and other applications.

Technical Specification

Electrical Specification		Interface	
Frequency, Min (GHz)	11	Output Type	Waveguide
Frequency, Max (GHz)	26.5	Flange Designation, WRD	FPWRD110C24
Waveguide Type	Double Ridge	Connector Gender	N/A
Waveguide Size EIA WRD	WRD110	Mechanical Specification	
Gain, Typ (dBi)	15	Figure	A Type
Polarization	Linear	Body Material	Al
3dB Beamwidth, E-Plane, Min (Deg.)	16	Finish	Chemical Conversion Coating, Gray Paint
3dB Beamwidth, E-Plane, Max (Deg.)	38	Size, W (mm)	52.1
3dB Beamwidth, H-Plane, Min (Deg.)	16	Size, H (mm)	43.1
3dB Beamwidth, H-Plane, Max (Deg.)	41	Size, L (mm)	88
Cross Pol. Isolation, Typ (dB)	35	Weight, (kg)	0.1
VSWR, Typ	1.5:1		

Additional Information

Application	General Purpose Indoor & Outdoor, Fixed	Solution for	Gain Reference Antenna Measurement Far-field Measurement System Intergration
-------------	---	--------------	---

Outline Drawing

FPWRD110C24 Output (P/N: LB-110265-15-A)

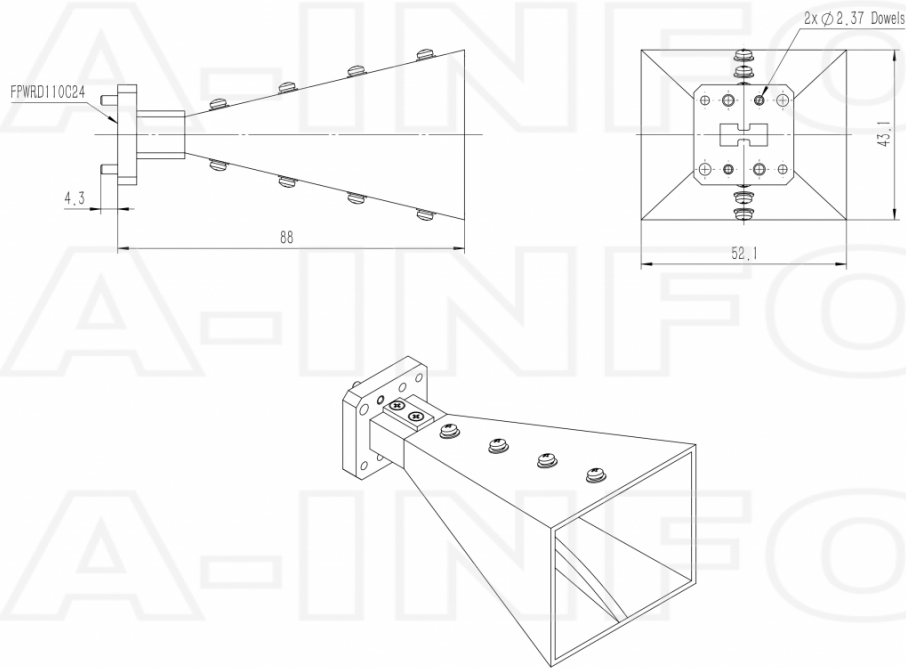

Flange Drawing

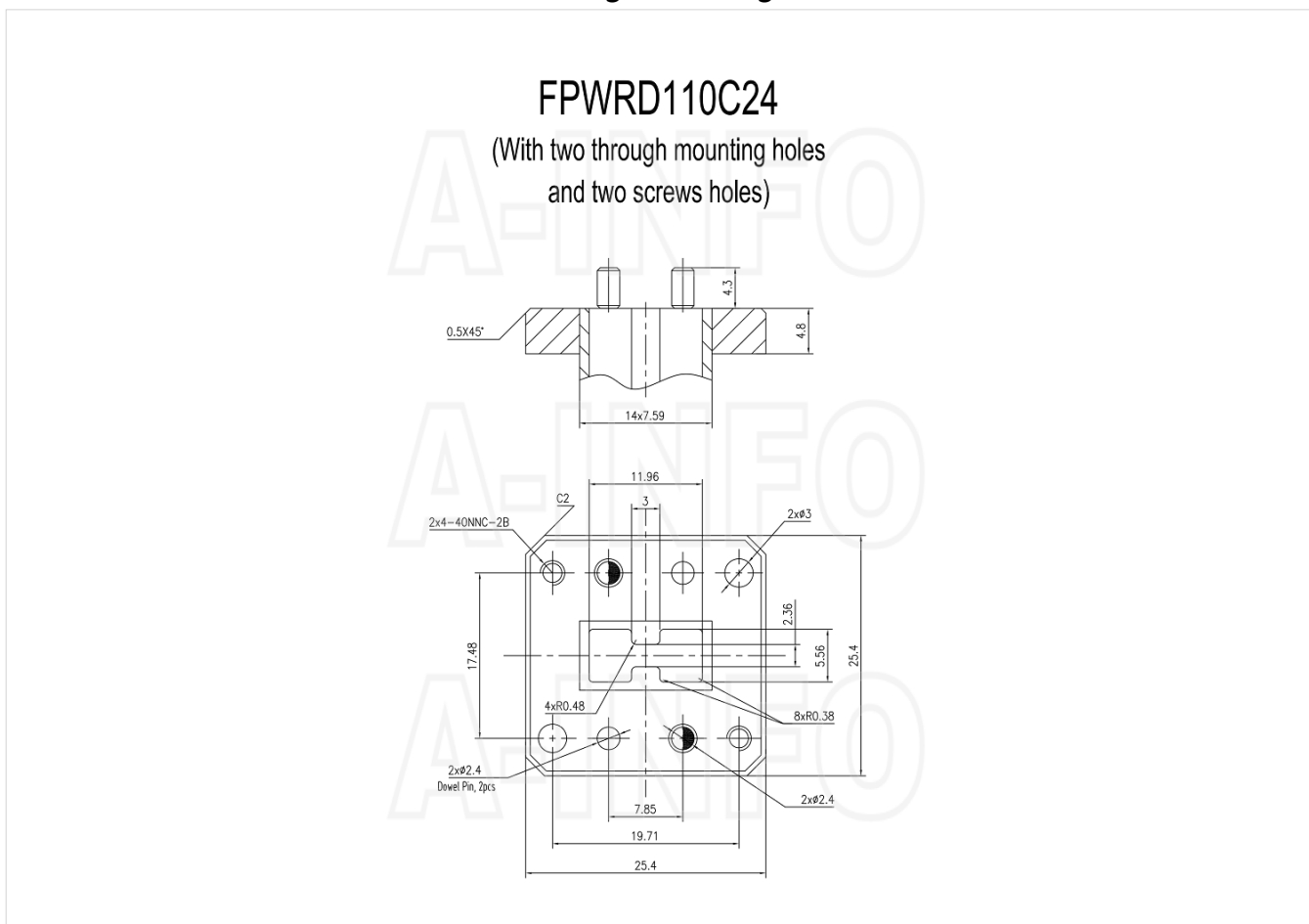

Typical Test Results

Gain

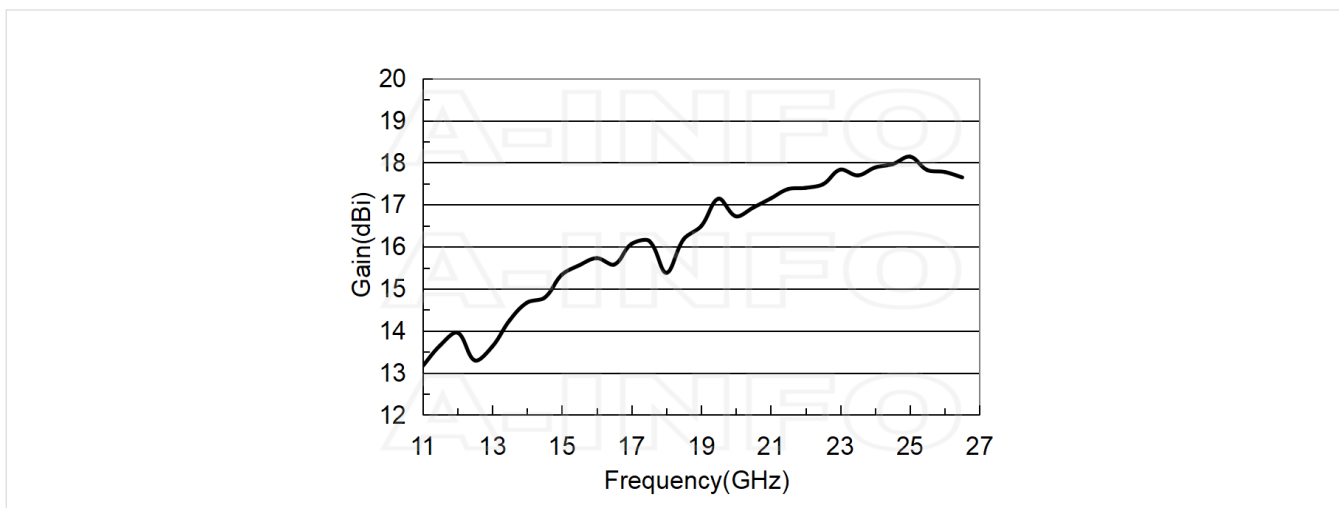

Antenna Factor

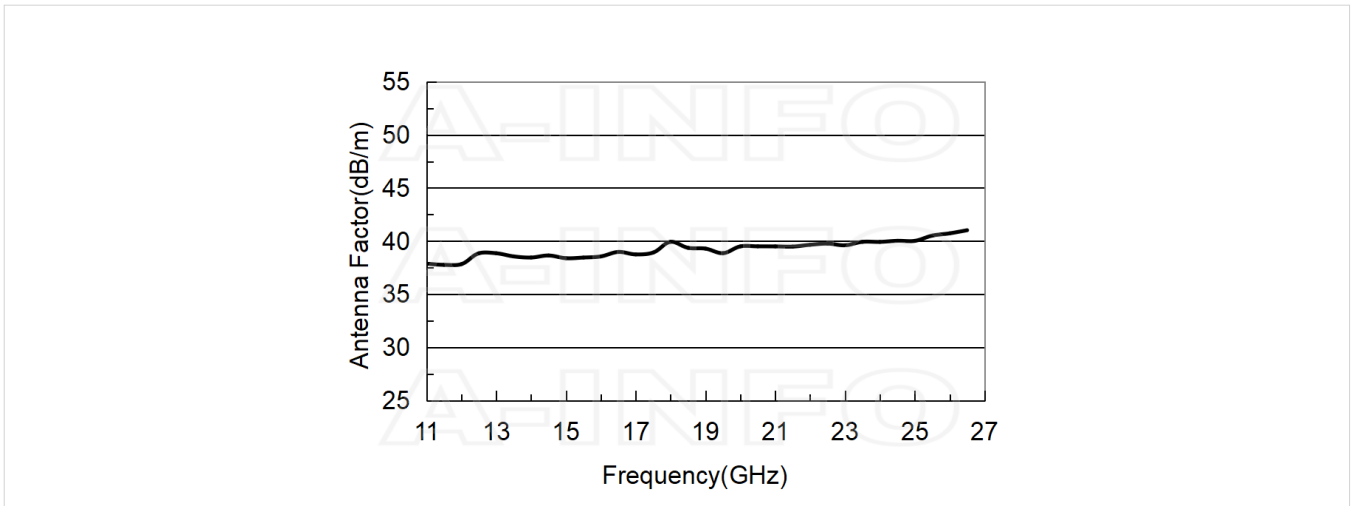

Antenna Factor (Table)

Frequency(GHz)	Gain(dBi)	AF(dB/m)
11.0	13.16	37.88
12.0	13.96	37.84
13.0	13.63	38.86
14.0	14.67	38.46
15.0	15.34	38.40
16.0	15.73	38.56
17.0	16.07	38.75
18.0	15.38	39.94
19.0	16.49	39.30
20.0	16.72	39.51
21.0	17.15	39.51
22.0	17.40	39.66
23.0	17.83	39.61
24.0	17.88	39.93
25.0	18.14	40.03
26.0	17.78	40.73
26.5	17.65	41.03

Cross Polarization Isolation

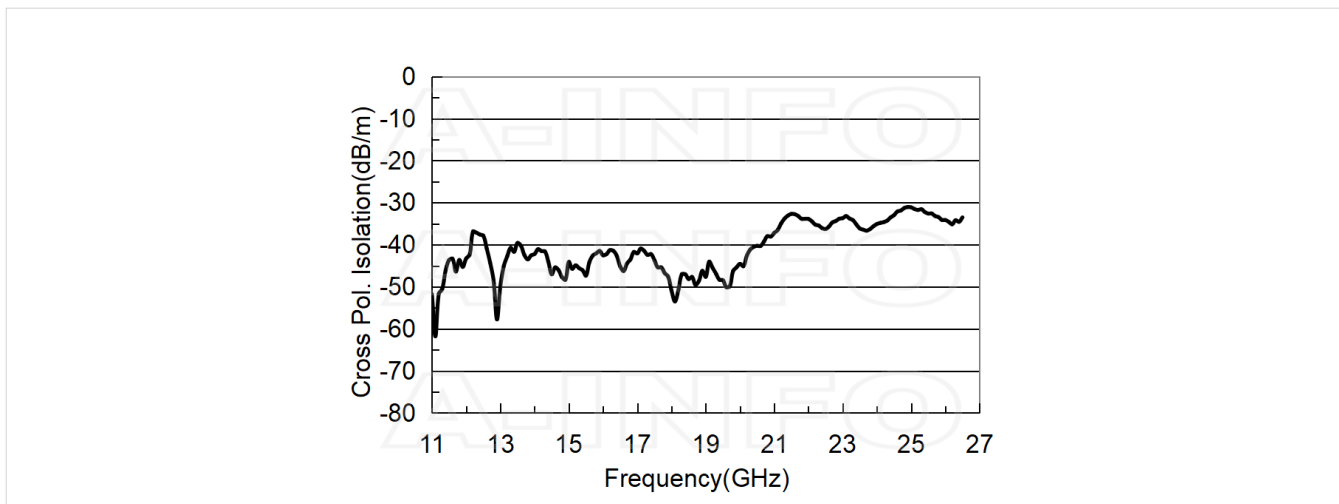

VSWR

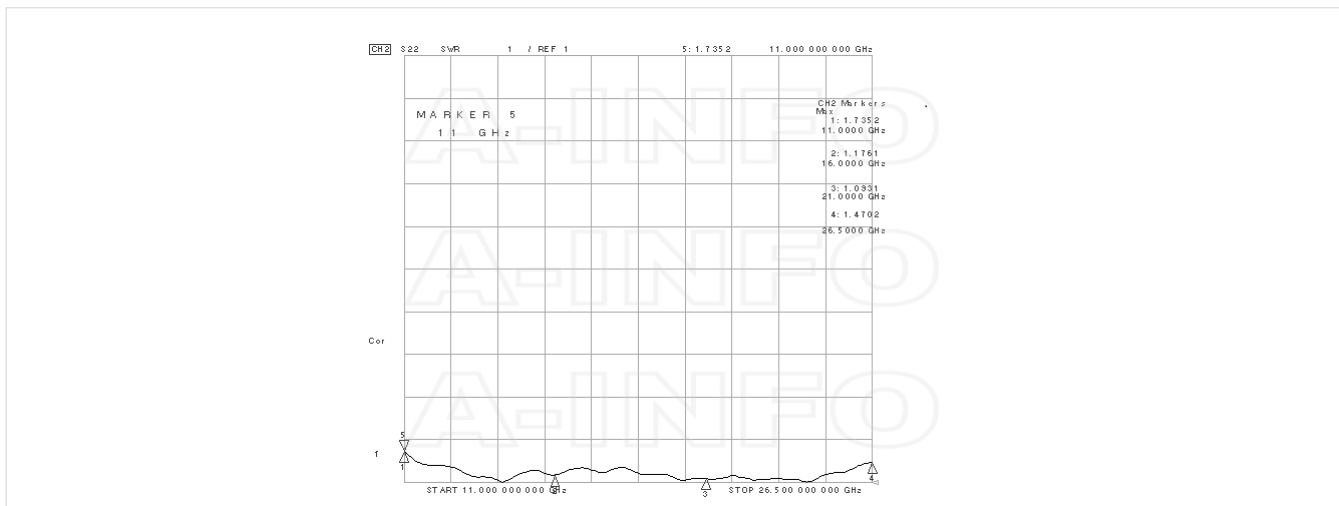

Beamwidth

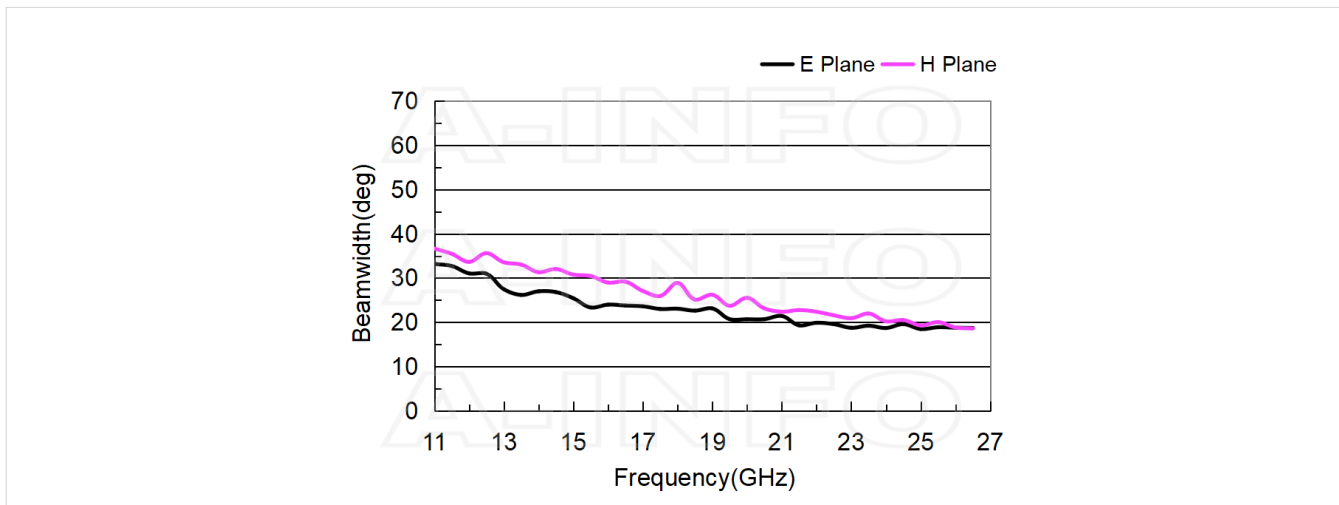

Pattern

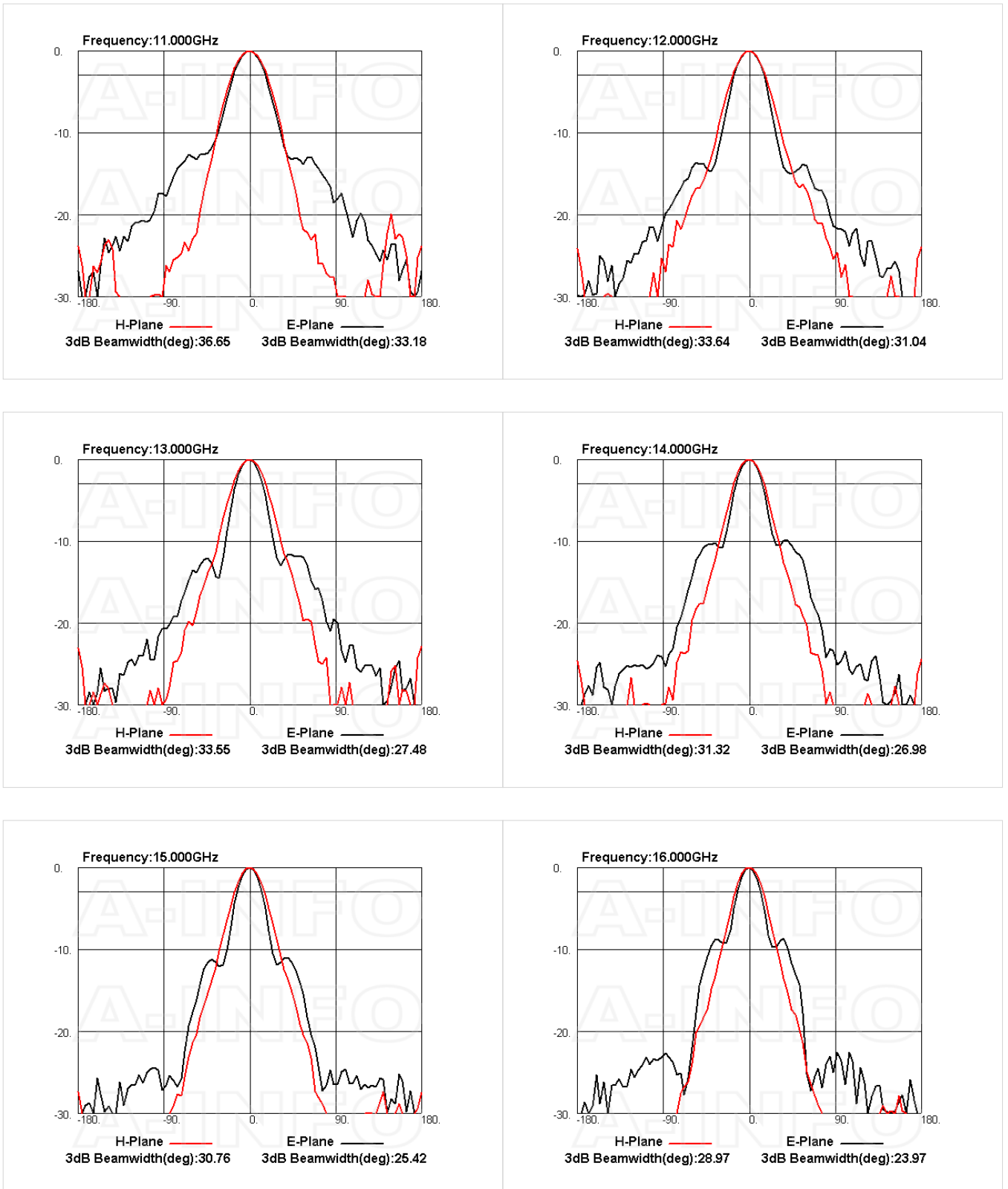

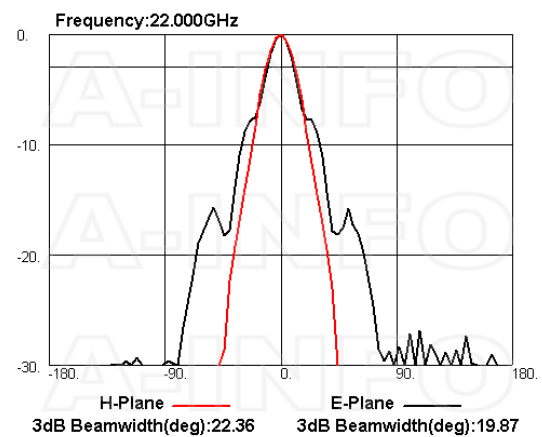
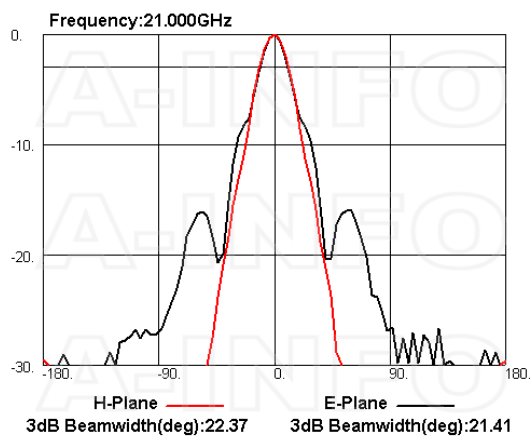
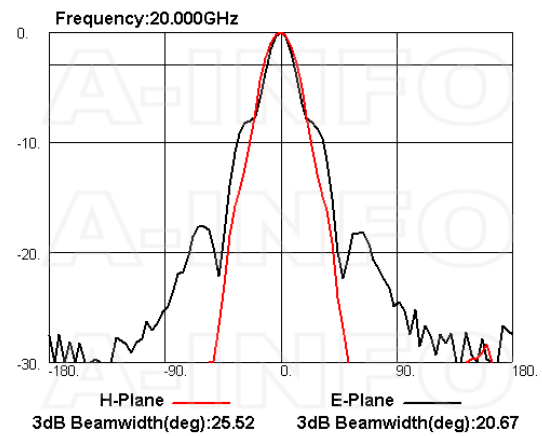
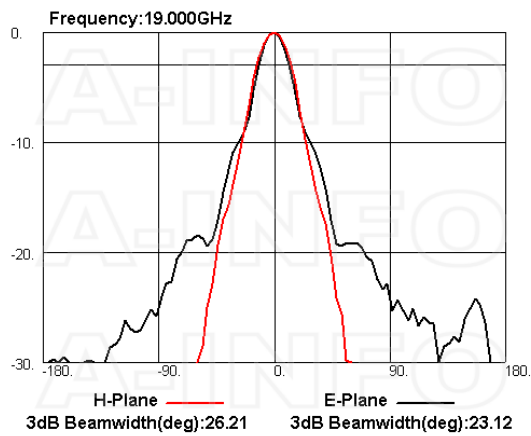
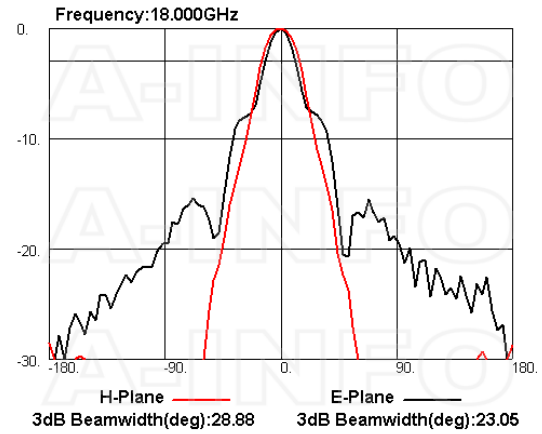
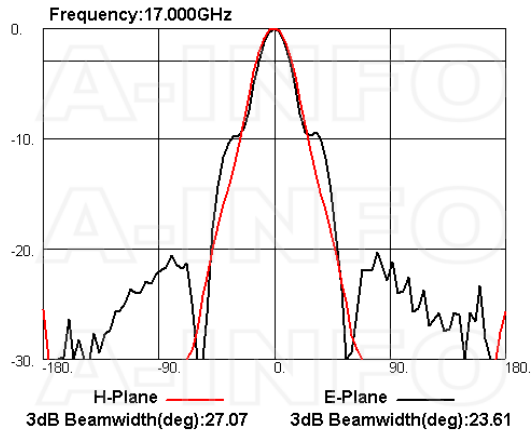

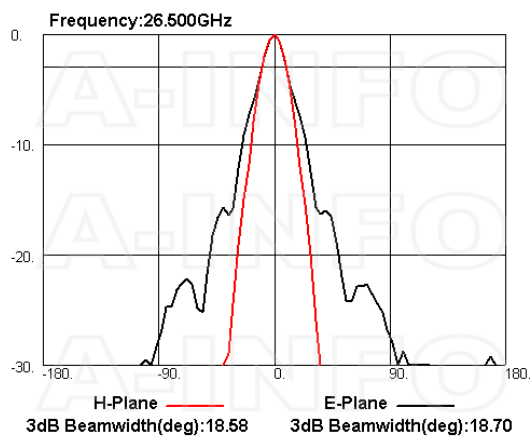
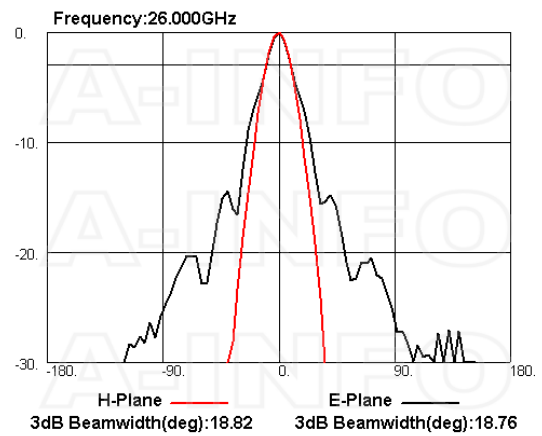
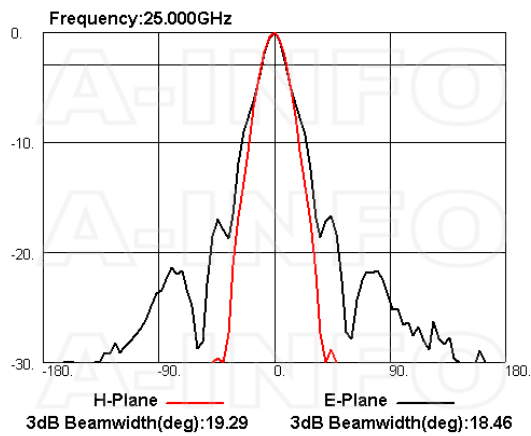
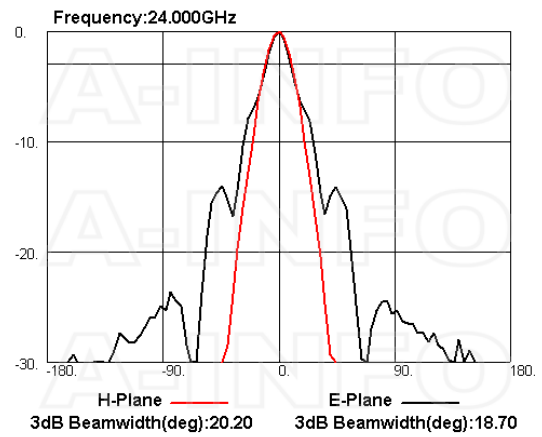
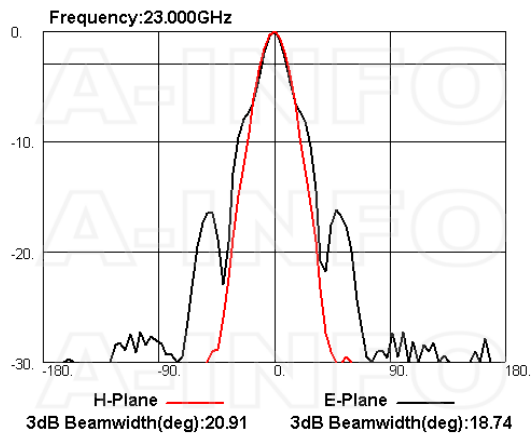

Related Products



110DRWCAS_Cu Right Angle Double Ridge Waveguide to Coaxial Adapter 11-26.5GHz WRD110 to SMA Female



110DRWECAS_Cu Endlaunch Double Ridge Waveguide to Coaxial Adapter 11-26.5GHz WRD110 to SMA Female

Similar Products

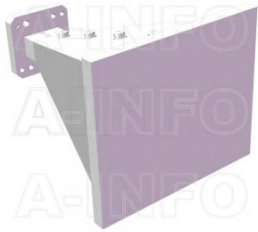

LB-110265-15-ASPO Multi Octave Horn Antenna 11-26.5GHz 15dB Gain Double Ridge Waveguide Interface

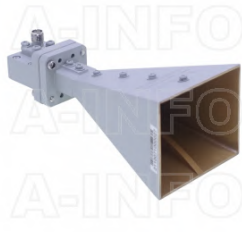

LB-110265-15-C-SF Multi Octave Horn Antenna 11-26.5GHz 15dB Gain SMA Female



LB-110265-15-C-SFSPO Multi Octave Horn Antenna 11-26.5GHz 15dB Gain SMA Female

About this Datasheet

<ul style="list-style-type: none"> ● Product Information Product Link: https://www.ainfoinc.com/lb-110265-15-a-multi-octave-horn-antenna-11-26-5-ghz-15db-gain-fpwr110c24 Data subject to change without notice. © A-INFO INC. 2024. All Rights Reserved 	<ul style="list-style-type: none"> ● Contact Us Address: 60 Tesla, Irvine, CA 92618, USA Website: www.ainfoinc.com Email: sales@ainfoinc.com 	<ul style="list-style-type: none"> ● Phone & Fax Phone: +1-949-639-9688 +1-949-639-9608 Fax: +1-949-639-9670
---	--	---