



LB-08420-15-C-NF Multi Octave Horn Antenna 0.84-2GHz 15dB Gain N Type Female

Multi Octave Horn Antenna Operating From 0.84GHz to 2GHz With a Nominal 15dB Gain With N Type Female Connector

### Product Information

SKU	LB-08420-15-C-NF
-----	------------------

### Description

Multi octave horn antenna LB-08420-15-C-NF, operating from 0.84 to 2GHz with a nominal 15dB gain and low VSWR 1.5:1 with N Type Female output connector. The model LB-08420-15-C-NF has uniform gain through its frequency span, providing efficient performance characteristics and directionality. It can handle 500W continuously and 5000W peak power. Constructed of lightweight corrosion-resistant aluminum, the antenna will provide years of trouble-free indoor and outdoor service. This octave horn antenna is linearly polarized and ideally suited for EMI testing, direction finding, surveillance, antenna gain and pattern measurements and other applications.

## Technical Specification

Electrical Specification		Interface	
Frequency, Min (GHz)	0.84	Output Type	Coaxial
Frequency, Max (GHz)	2	Connector	N Type
Waveguide Type	Double Ridge	Connector Gender	Female
Waveguide Size EIA WRD	WRD84	Mechanical Specification	
Gain, Typ (dBi)	15	Figure	C Type
Polarization	Linear	Body Material	Al
3dB Beamwidth, E-Plane, Min (Deg.)	13	Finish	Chemical Conversion Coating, Gray Paint
3dB Beamwidth, E-Plane, Max (Deg.)	50	Size, W (mm)	586
3dB Beamwidth, H-Plane, Min (Deg.)	15	Size, H (mm)	436
3dB Beamwidth, H-Plane, Max (Deg.)	43	Size, L (mm)	769
Cross Pol. Isolation, Typ (dB)	35	Weight, (kg)	10.5
VSWR, Typ	1.5:1		
Impedance, (Ohm)	50		
Power Handling, CW, (W)	500		
Power Handling, Peak, (W)	5000		

## Additional Information

Application	General Purpose Indoor & Outdoor, Fixed	Solution for	Gain Reference Antenna Measurement Far-field Measurement System Intergration
-------------	---	--------------	---

## Outline Drawing

N-Female Output (P/N: LB-08420-15-C-NF)

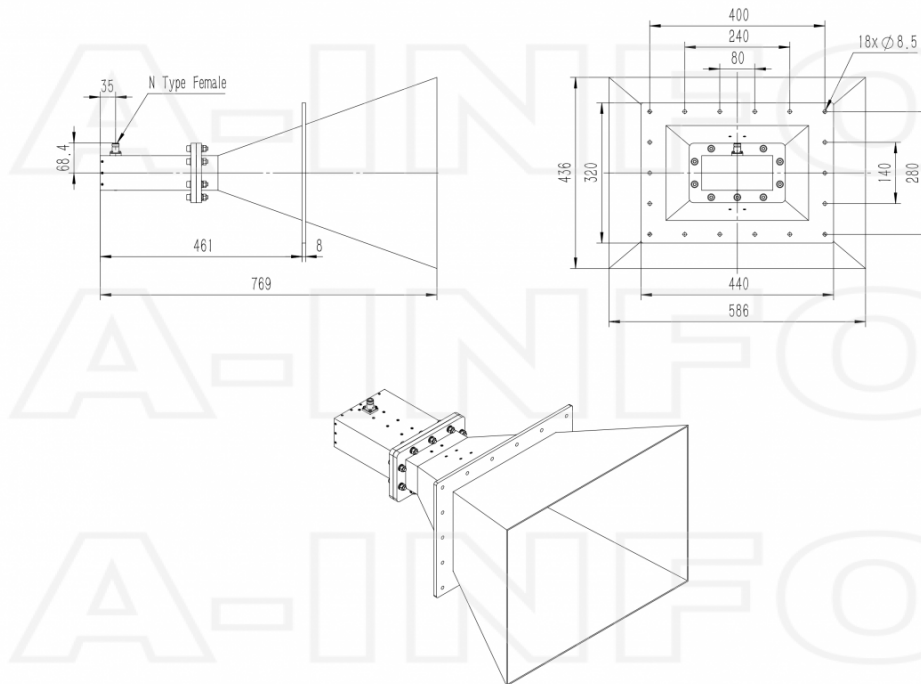

N-Female Output with Round Mounting Bracket (Option, P/N: LB-08420-10-C-MB)

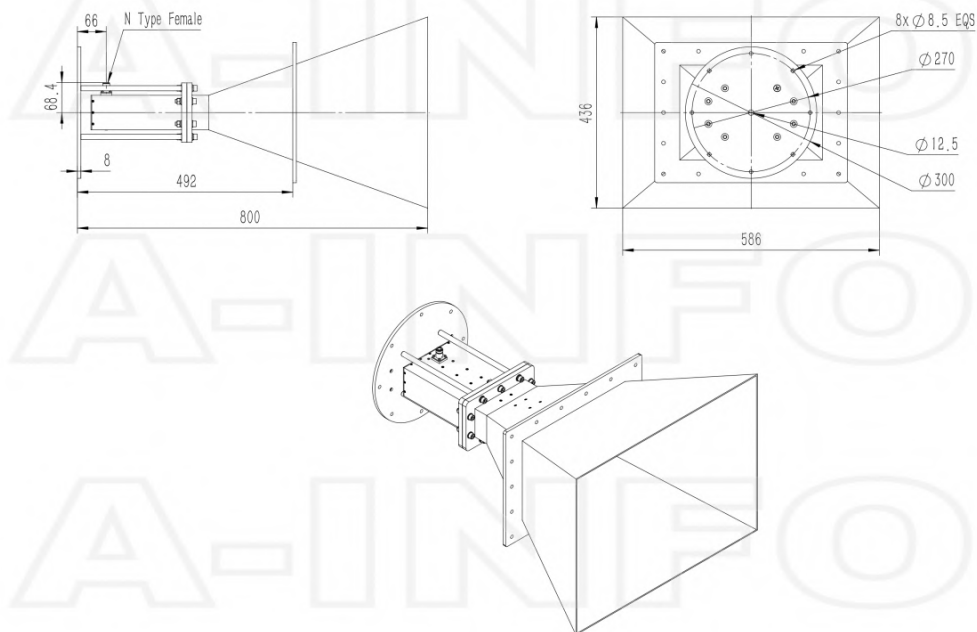

N-Female Output with L Type Mounting Bracket (Option, P/N: LB-08420-15-C-L)

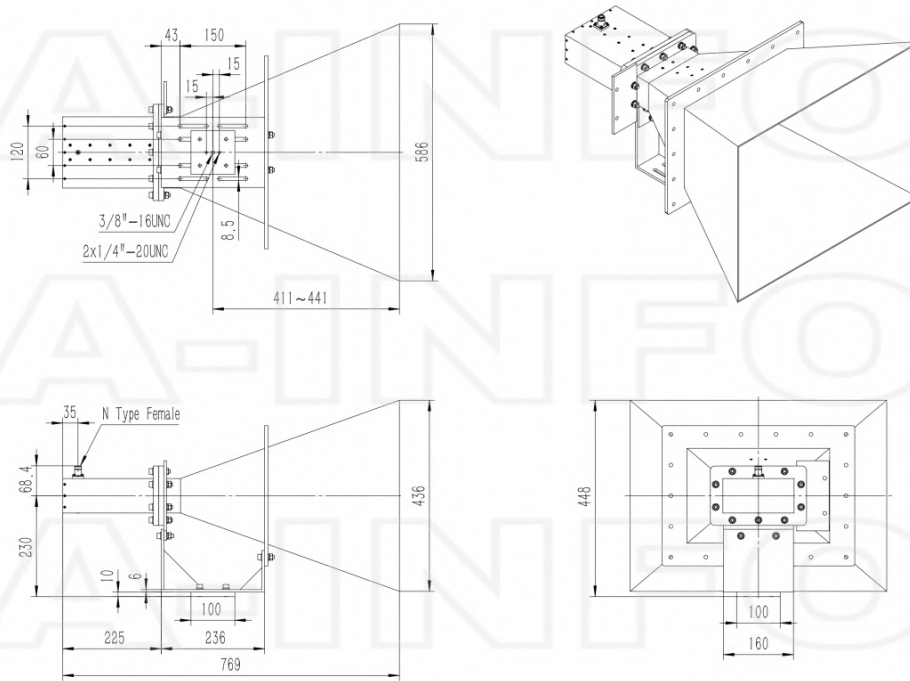

## Typical Test Results

Gain

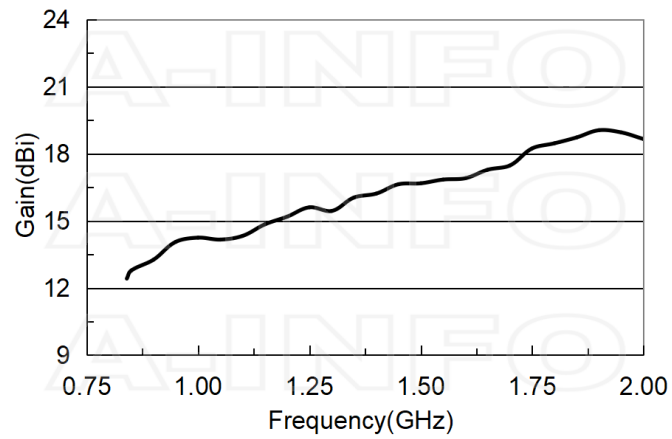

## Antenna Factor

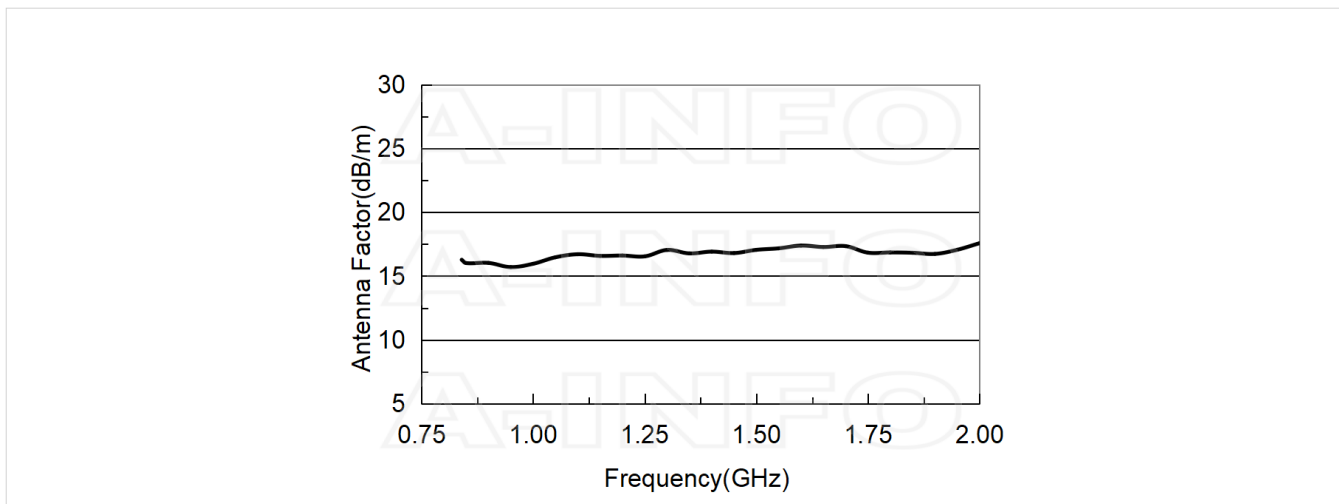

## Antenna Factor (Table)

Frequency(GHz)	Gain(dBi)	AF(dB/m)
0.84	12.42	16.28
0.90	13.26	16.03
1.00	14.25	15.96
1.10	14.33	16.71
1.20	15.19	16.61
1.30	15.44	17.05
1.40	16.22	16.91
1.50	16.68	17.05
1.60	16.91	17.39
1.70	17.48	17.34
1.80	18.47	16.85
1.90	19.05	16.73
2.00	18.66	17.57

## Cross Polarization Isolation

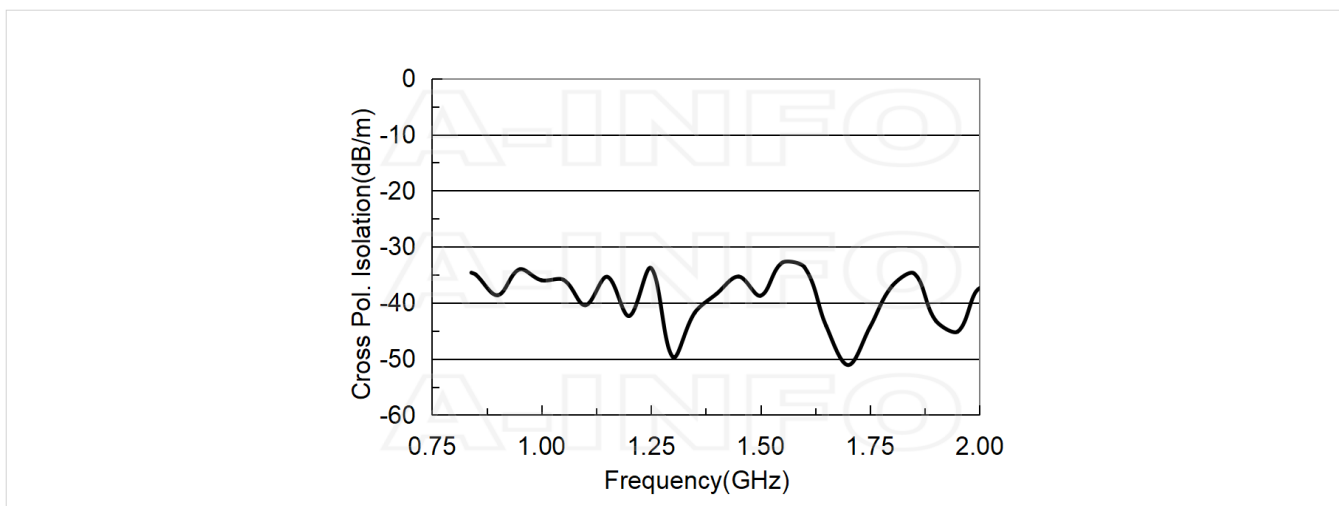

## VSWR

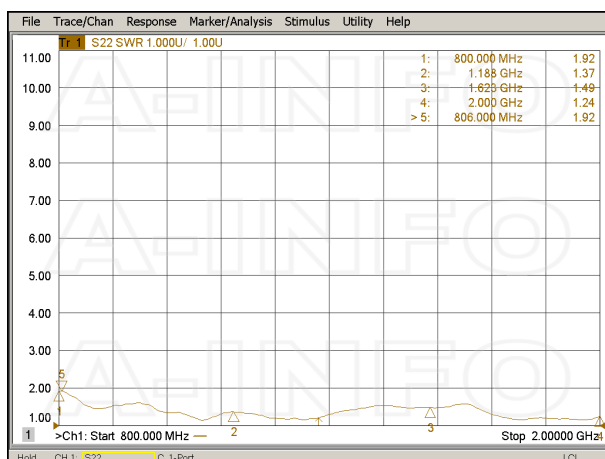

## Beamwidth

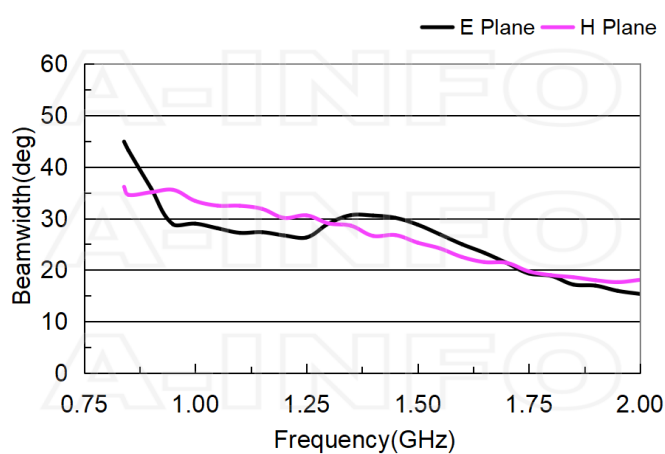

## Pattern

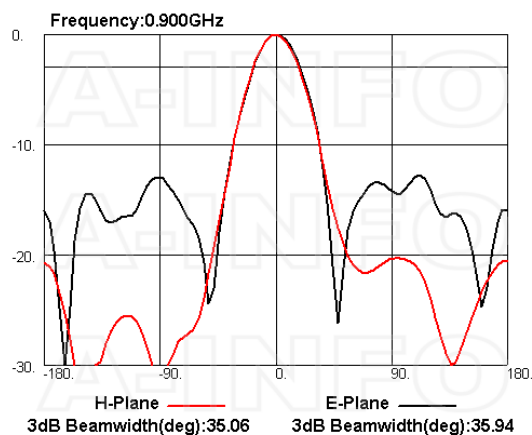
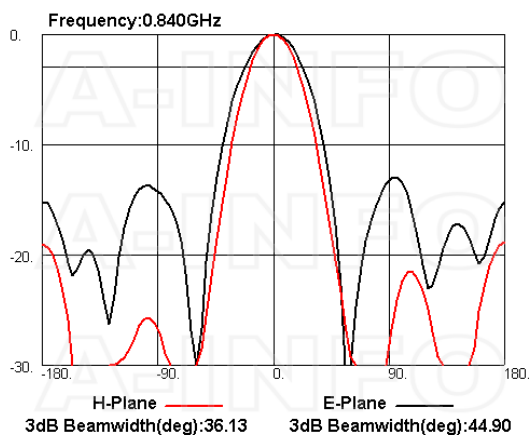

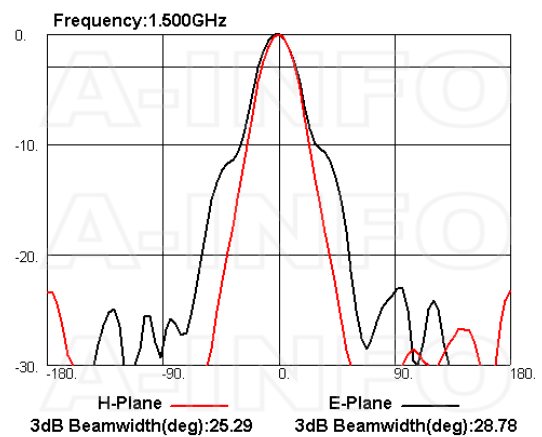
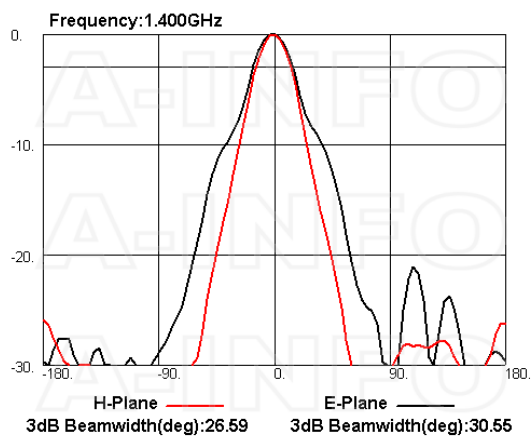
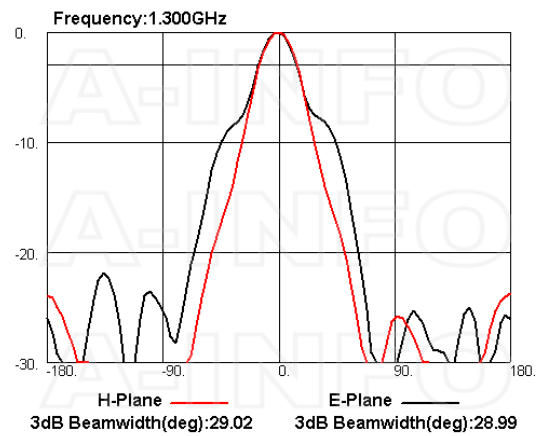
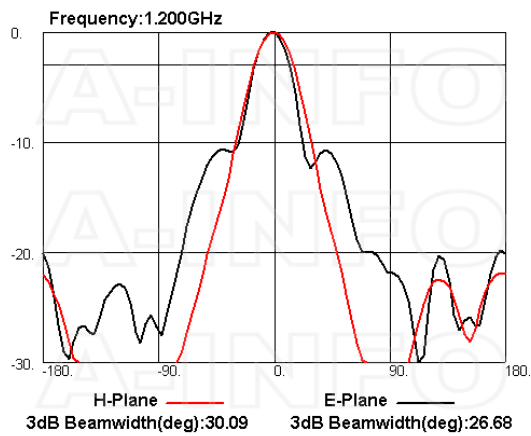
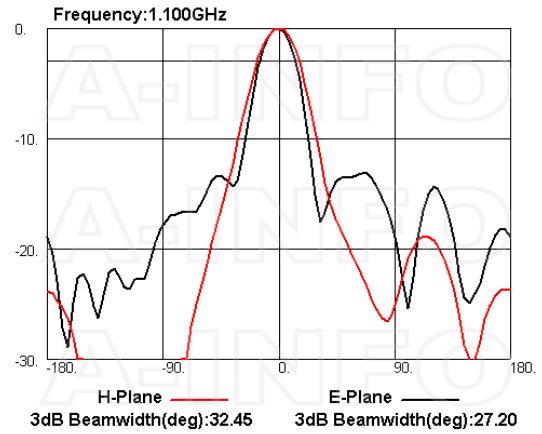
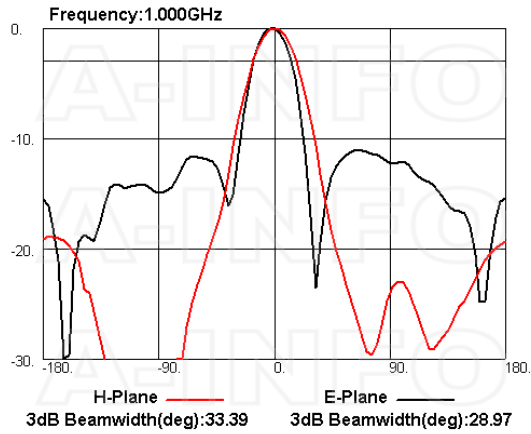

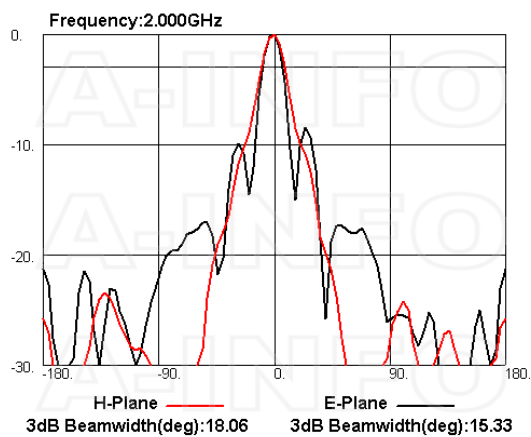
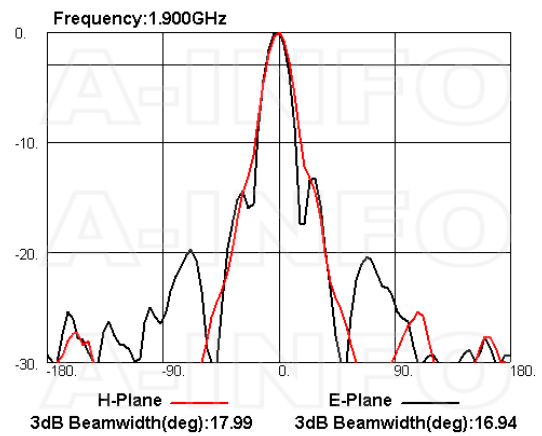
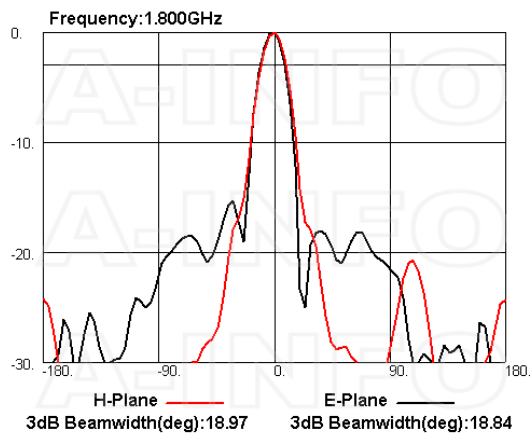
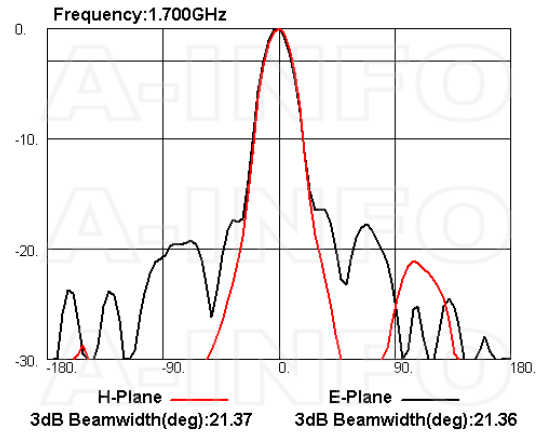
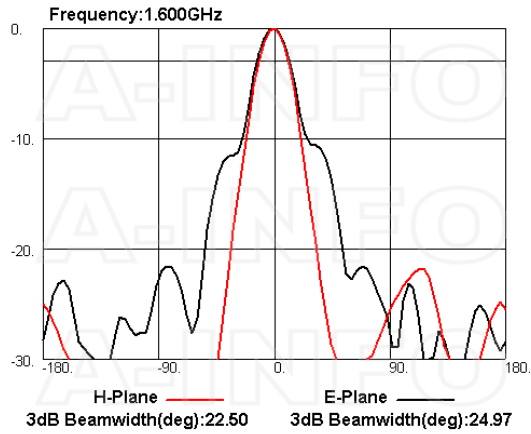

## Related Products



LB-08420-10-C-MB Round Type Mounting Bracket



LB-08420-15-C-L L type mounting bracket



Tripod\_50Kg Al Alloy Tripod



NM-NM-A050-1000 Flexible Cable Assembly 1000mm DC-18GHz N Male to N Male



NM-NM-A050-1500 Flexible Cable Assembly 1500mm DC-18GHz N Male to N Male



NM-NM-A050-2000 Flexible Cable Assembly 2000mm DC-18GHz N Male to N Male



NM-NM-A050-3000 Flexible Cable Assembly 3000mm DC-18GHz N Male to N Male



NM-NM-A050-5000 Flexible Cable Assembly 5000mm DC-18GHz N Male to N Male



NM-NM-A050-10000 Flexible Cable Assembly 10000mm DC-18GHz N Male to N Male



NM-NM-A050-20000 Flexible Cable Assembly 20000mm DC-18GHz N Male to N Male



NM-NM-A100-500 Flexible Cable Assembly 500mm DC-18GHz N Male to N Male



NM-NM-A100-1000 Flexible Cable Assembly 1000mm DC-18GHz N Male to N Male



NM-NM-A100-1500 Flexible Cable Assembly 1500mm DC-18GHz N Male to N Male



NM-NM-A100-2000 Flexible Cable Assembly 2000mm DC-18GHz N Male to N Male



NM-NM-A100-3000 Flexible Cable Assembly 3000mm DC-18GHz N Male to N Male



NM-NM-A100-5000 Flexible Cable Assembly 5000mm DC-18GHz N Male to N Male



NM-NM-A100-10000 Flexible Cable Assembly 10000mm DC-18GHz N Male to N Male



NM-NM-A100-20000 Flexible Cable Assembly 20000mm DC-18GHz N Male to N Male

## Similar Products

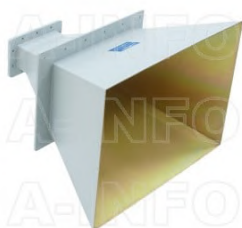

LB-08420-15-A Multi Octave Horn Antenna 0.84-2GHz 15dB Gain Double Ridge Waveguide Interface

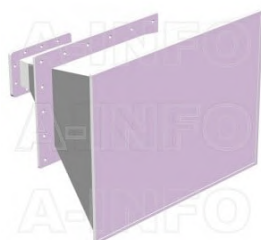

LB-08420-15-ASPO Multi Octave Horn Antenna 0.84-2GHz 15dB Gain Double Ridge Waveguide Interface



LB-08420-15-C-NFSPO Multi Octave Horn Antenna 0.84-2GHz 15dB Gain N Type Female

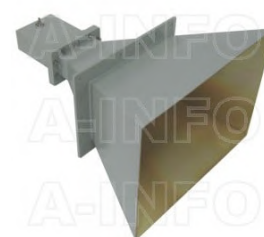

LB-08420-15-C-SF Multi Octave Horn Antenna 0.84-2GHz 15dB Gain SMA Female



LB-08420-15-C-SFSPO Multi Octave Horn Antenna 0.84-2GHz 15dB Gain SMA Female

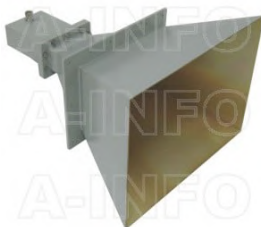

LB-08420-15-C-7/16F Multi Octave Horn Antenna 0.84-2GHz 15dB Gain 7/16 DIN Female



LB-08420-15-C-7/16FSPO Multi Octave Horn Antenna 0.84-2GHz 15dB Gain 7/16 DIN Female

## About this Datasheet

<ul style="list-style-type: none"> <li>● <b>Product Information</b> Product Link: <a href="https://www.ainfoinc.com/lb-08420-15-c-nf-multi-octave-horn-antenna-0-84-2-ghz-15db-gain-n-type-female-480">https://www.ainfoinc.com/lb-08420-15-c-nf-multi-octave-horn-antenna-0-84-2-ghz-15db-gain-n-type-female-480</a> Data subject to change without notice. © A-INFO INC. 2024. All Rights Reserved</li> </ul>	<ul style="list-style-type: none"> <li>● <b>Contact Us</b> Address: 60 Tesla, Irvine, CA 92618, USA  Website: <a href="http://www.ainfoinc.com">www.ainfoinc.com</a>  Email: <a href="mailto:sales@ainfoinc.com">sales@ainfoinc.com</a></li> </ul>	<ul style="list-style-type: none"> <li>● <b>Phone &amp; Fax</b> Phone: +1-949-639-9688 +1-949-639-9608  Fax: +1-949-639-9670</li> </ul>
---	--	---