

LB-08420-15-A Multi Octave Horn Antenna 0.84-2GHz 15dB Gain Double Ridge Waveguide Interface

Multi Octave Horn Antenna From 0.84GHz to 2GHz With a Nominal 15dB Gain With Double Ridge Waveguide Interface

### Product Information

SKU	LB-08420-15-A
-----	---------------

### Description

Multi octave horn antenna LB-08420-15-A, operating from 0.84 to 2GHz with a nominal 15dB gain and low VSWR 1.5:1 with FPWRD84D24 output. The model LB-08420-15-A has uniform gain through its frequency span, providing efficient performance characteristics and directionality. Constructed of lightweight corrosion-resistant aluminum, the antenna will provide years of trouble-free indoor and outdoor service. This octave horn antenna is linearly polarized and ideally suited for EMI testing, direction finding, surveillance, antenna gain and pattern measurements and other applications.

### Technical Specification

Electrical Specification		Interface	
Frequency, Min (GHz)	0.84	Output Type	Waveguide
Frequency, Max (GHz)	2	Flange Designation, WRD	FPWRD84D24
Waveguide Type	Double Ridge	Connector Gender	N/A
Waveguide Size EIA WRD	WRD84	Mechanical Specification	
Gain, Typ (dBi)	15	Figure	A Type
Polarization	Linear	Body Material	Al
3dB Beamwidth, E-Plane, Min (Deg.)	13	Finish	Chemical Conversion Coating, Gray Paint
3dB Beamwidth, E-Plane, Max (Deg.)	50	Size, W (mm)	586
3dB Beamwidth, H-Plane, Min (Deg.)	15	Size, H (mm)	436
3dB Beamwidth, H-Plane, Max (Deg.)	43	Size, L (mm)	550
Cross Pol. Isolation, Typ (dB)	35	Weight, (kg)	7.8
VSWR, Typ	1.5:1		

## Additional Information

Application	General Purpose Indoor & Outdoor, Fixed	Solution for	Gain Reference Antenna Measurement Far-field Measurement System Intergration
-------------	---	--------------	---

## Outline Drawing

FPWRD84D24 Output (P/N: LB-08420-15-A)

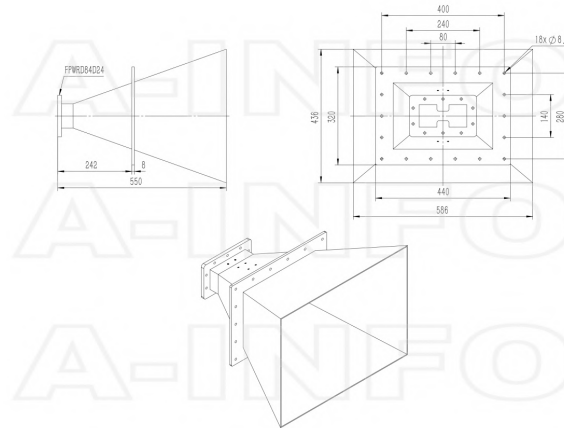

## Flange Drawing

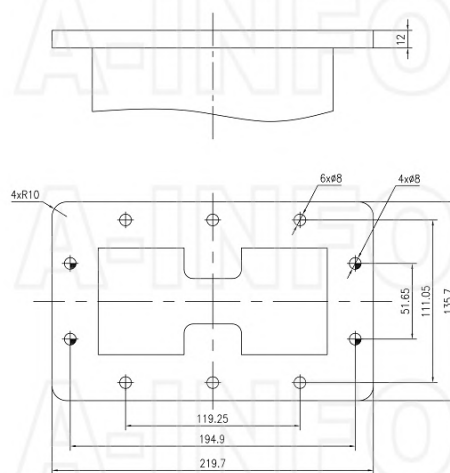

## Typical Test Results

### Gain

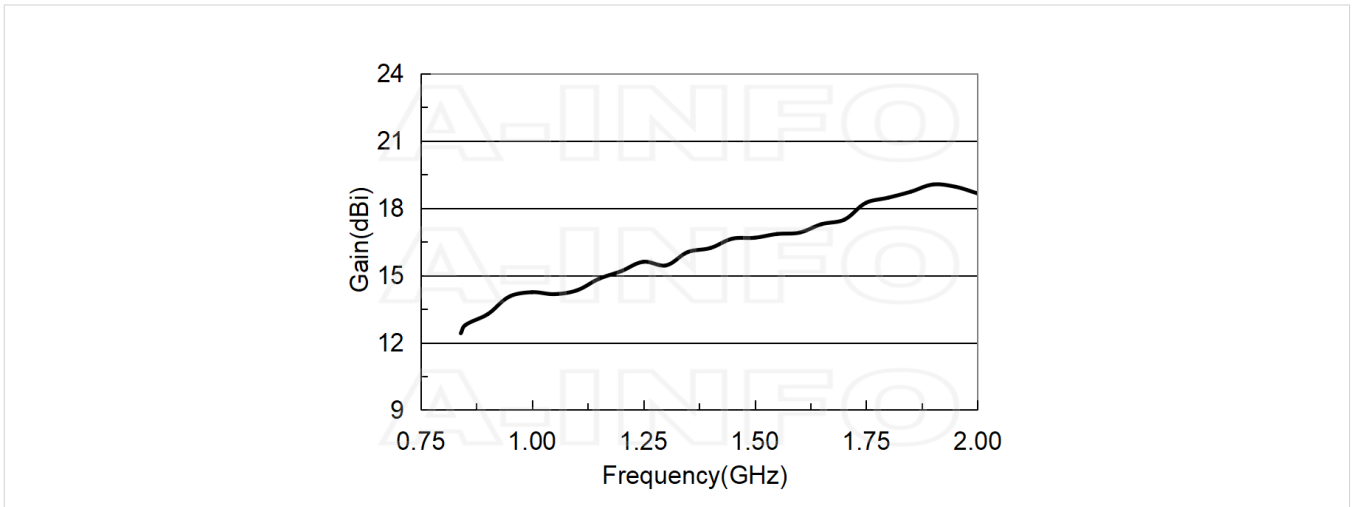

### Antenna Factor

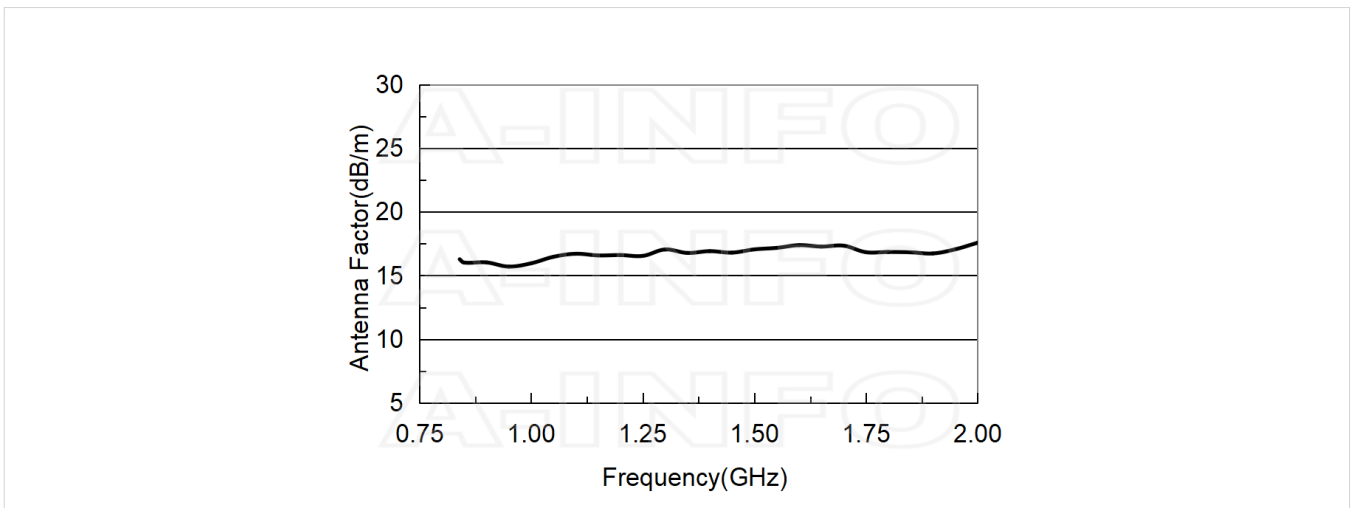

### Antenna Factor (Table)

Frequency(GHz)	Gain(dBi)	AF(dB/m)
0.84	12.42	16.28
0.90	13.26	16.03
1.00	14.25	15.96
1.10	14.33	16.71
1.20	15.19	16.61
1.30	15.44	17.05
1.40	16.22	16.91
1.50	16.68	17.05
1.60	16.91	17.39
1.70	17.48	17.34
1.80	18.47	16.85
1.90	19.05	16.73
2.00	18.66	17.57

## Cross Polarization Isolation

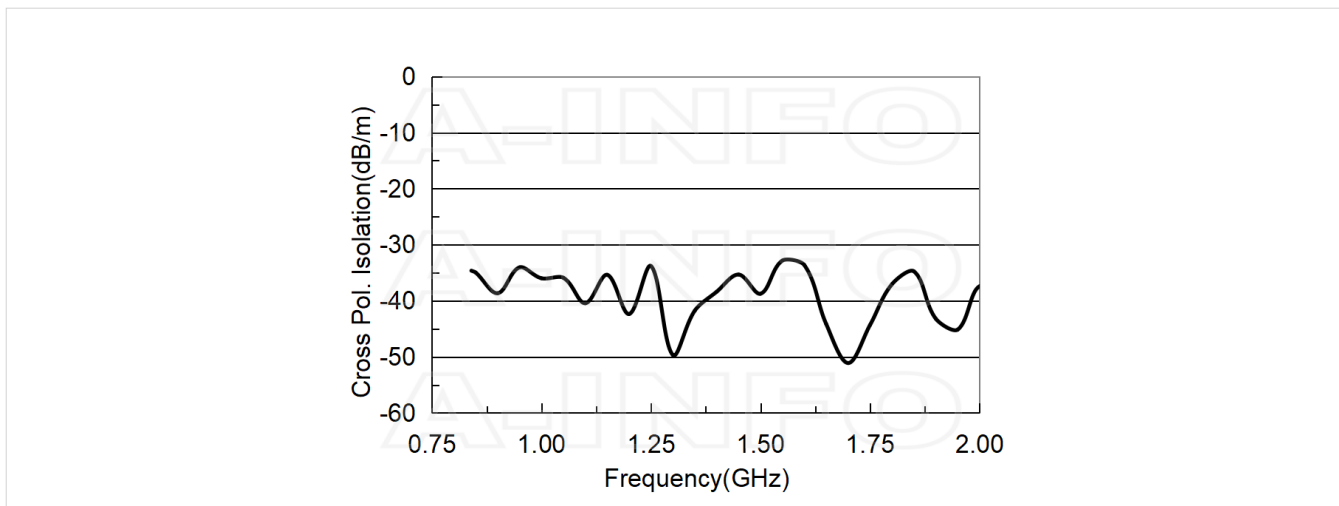

## VSWR

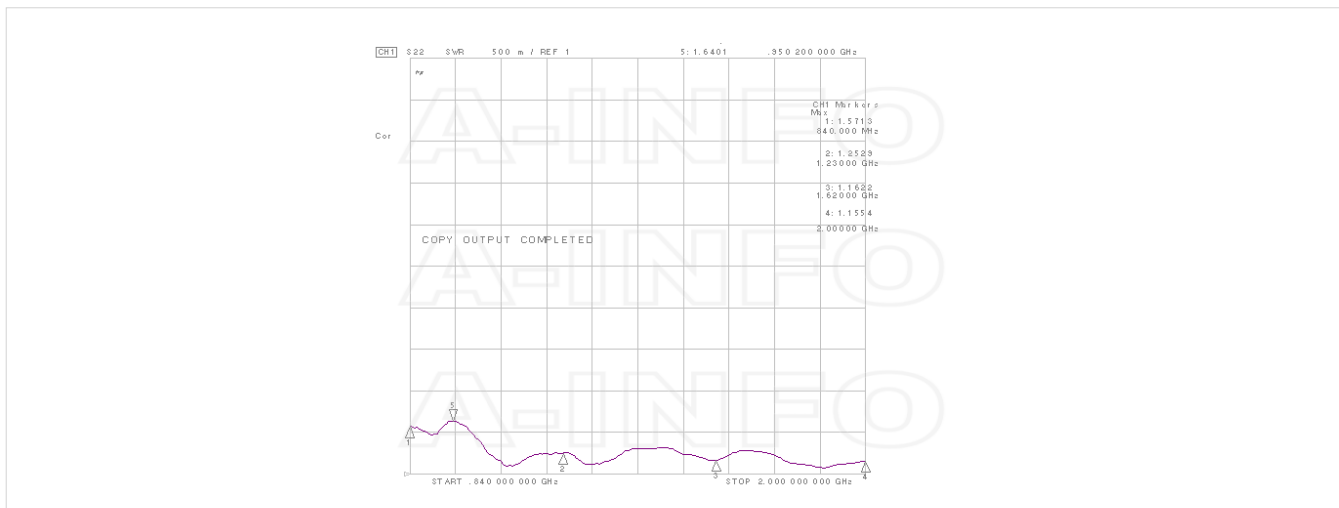

## Beamwidth

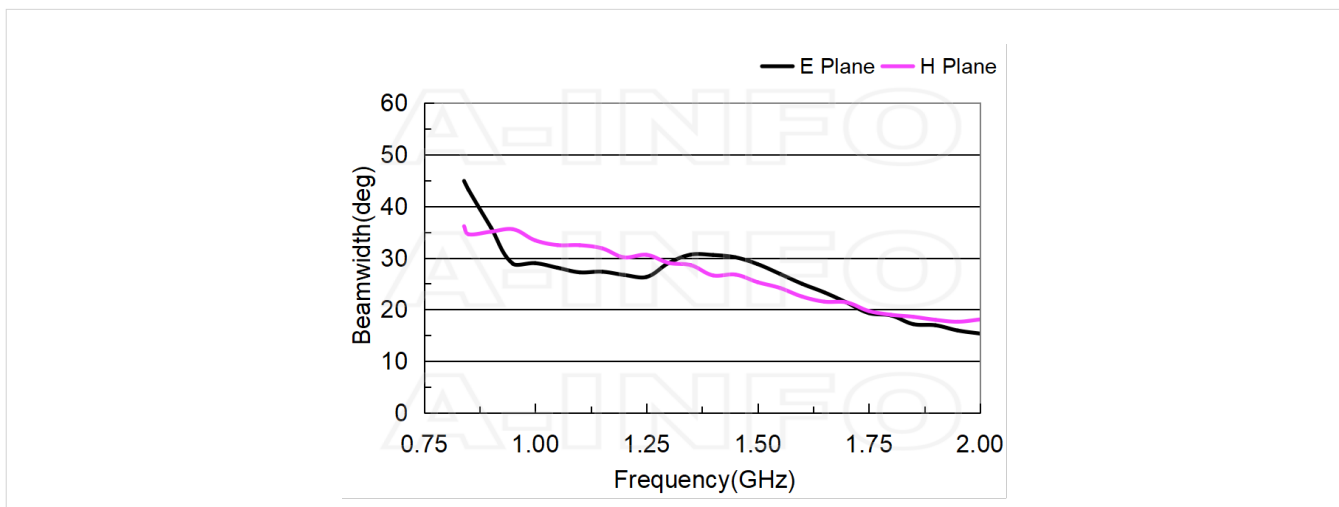

## Pattern

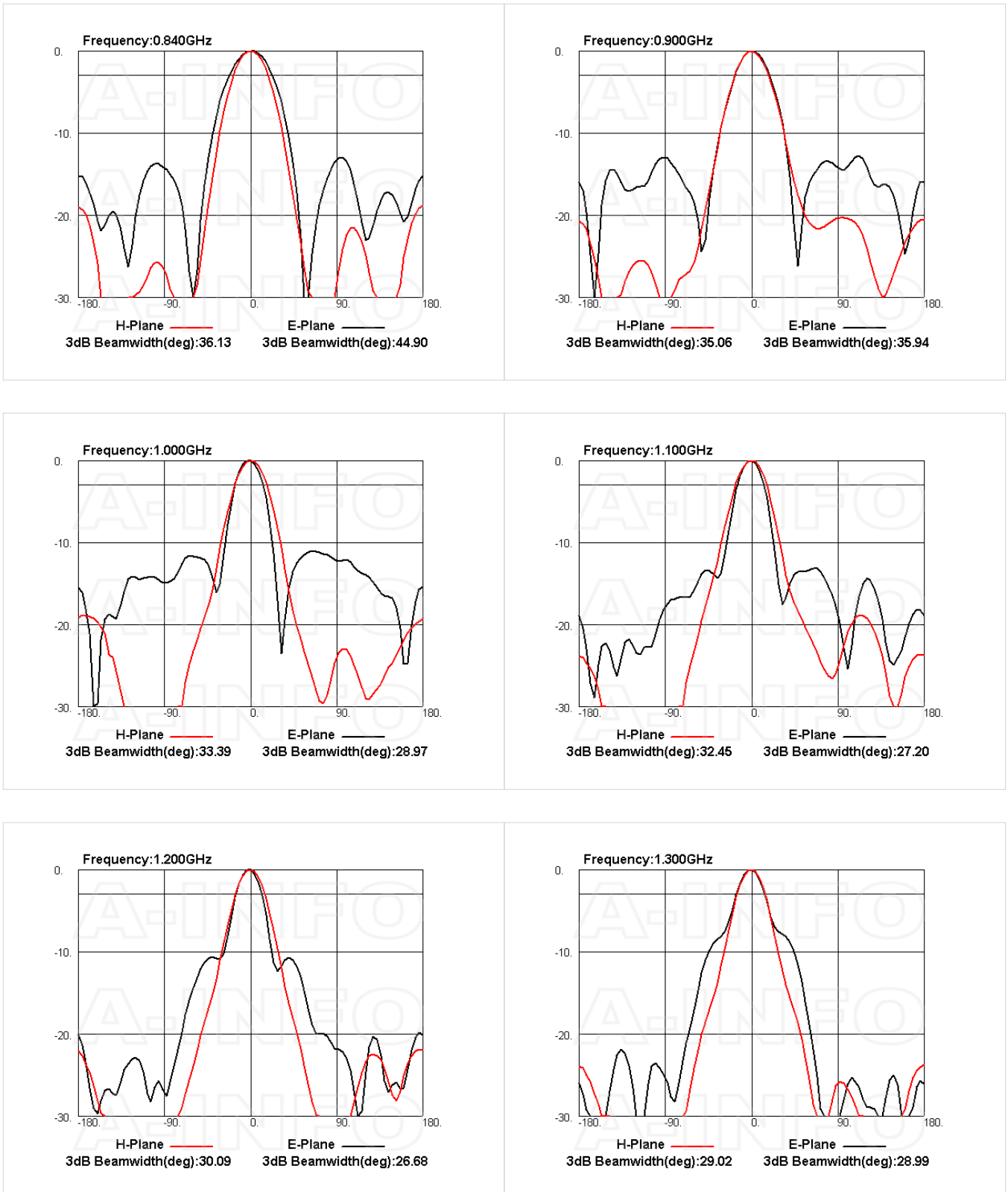

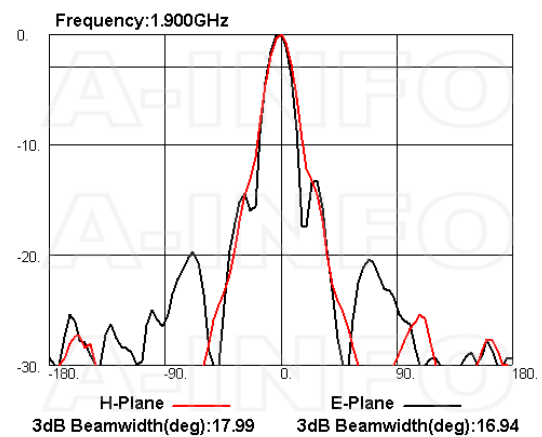
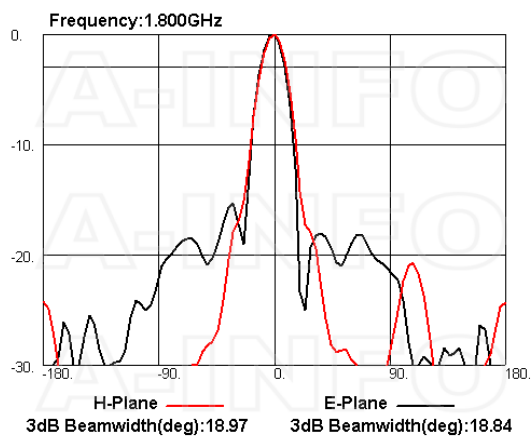
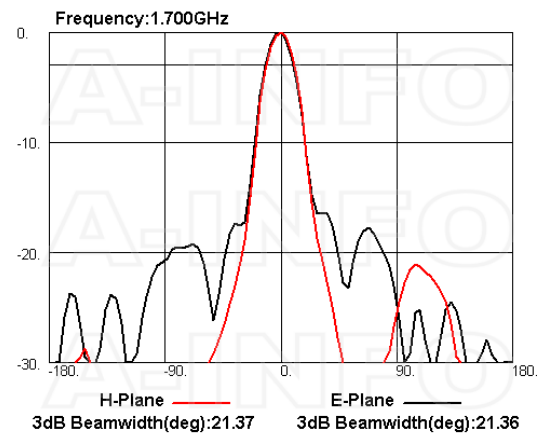
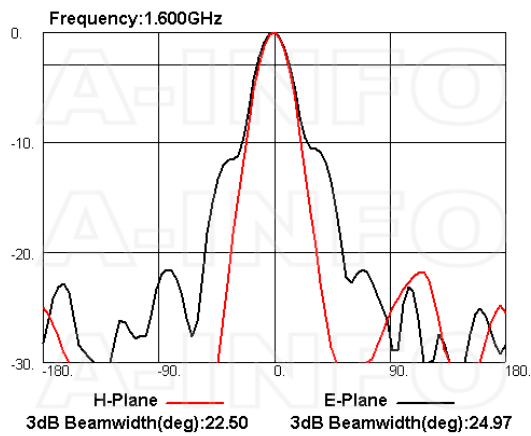
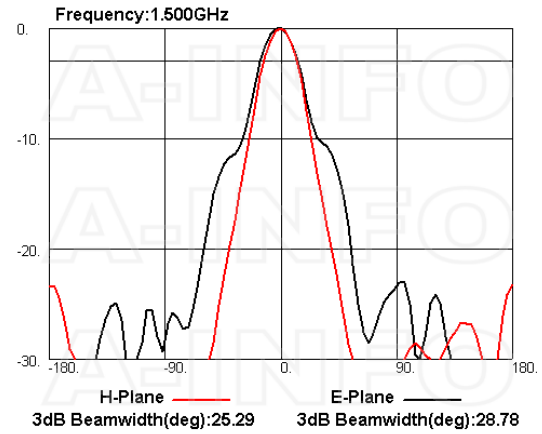
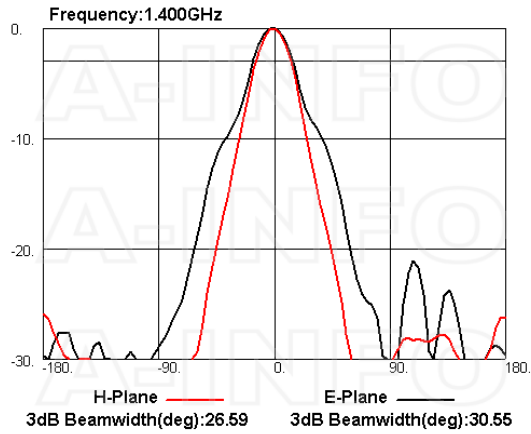

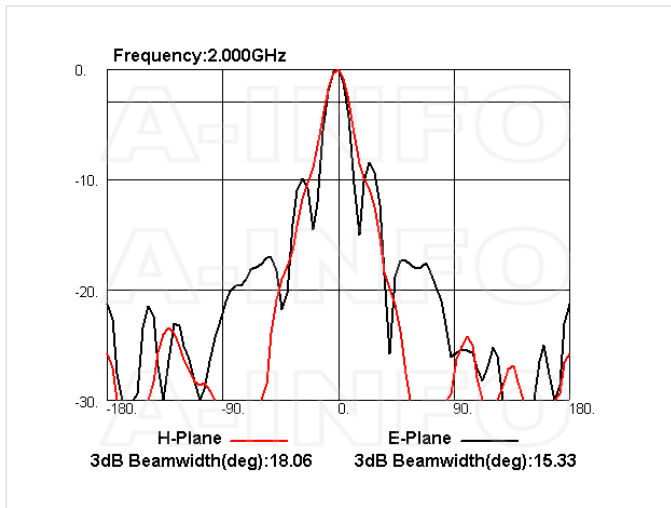

## Related Products



84DRWCAN Right Angle Double Ridge Waveguide to Coaxial Adapter 0.84-2GHz WRD84 to N Type Female



84DRWECAN Endlaunch Double Ridge Waveguide to Coaxial Adapter 0.84-2GHz WRD84 to N Type Female

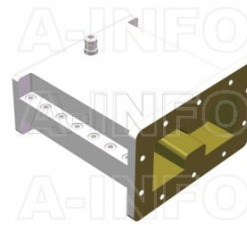

84DRWHCAN Right Angle High Power Double Ridge Waveguide to Coaxial Adapter 0.84-2GHz WRD84 to N Type Female



LB-08420-10-C-MB Round Type Mounting Bracket



LB-08420-15-C-L L type mounting bracket



Tripod\_50Kg Al Alloy Tripod

## Similar Products

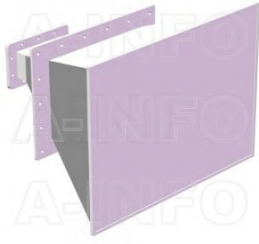

LB-08420-15-ASPO Multi Octave Horn Antenna 0.84-2GHz 15dB Gain Double Ridge Waveguide Interface



LB-08420-15-C-NF Multi Octave Horn Antenna 0.84-2GHz 15dB Gain N Type Female



LB-08420-15-C-NFSPO Multi Octave Horn Antenna 0.84-2GHz 15dB Gain N Type Female



LB-08420-15-C-SF Multi Octave Horn Antenna 0.84-2GHz 15dB Gain SMA Female



LB-08420-15-C-SFSPO Multi Octave Horn Antenna 0.84-2GHz 15dB Gain SMA Female

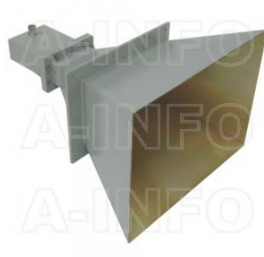

LB-08420-15-C-7/16F Multi Octave Horn Antenna 0.84-2GHz 15dB Gain 7/16 DIN Female



LB-08420-15-C-7/16FSPO Multi Octave Horn Antenna 0.84-2GHz 15dB Gain 7/16 DIN Female

## About this Datasheet

- Product Information

Product Link:  
<https://www.ainfoinc.com/lb-08420-15-a-multi-octave-horn-antenna-0-84-2-ghz-15db-gain-fpwr84d24-490>  
 Data subject to change without notice.  
 © A-INFO INC. 2024. All Rights Reserved

- Contact Us

Address:  
 60 Tesla, Irvine, CA 92618,  
 USA

Website:  
[www.ainfoinc.com](http://www.ainfoinc.com)

Email:  
[sales@ainfoinc.com](mailto:sales@ainfoinc.com)

- Phone & Fax

Phone:  
 +1-949-639-9688  
 +1-949-639-9608

Fax:  
 +1-949-639-9670