

TOP

BOTTOM

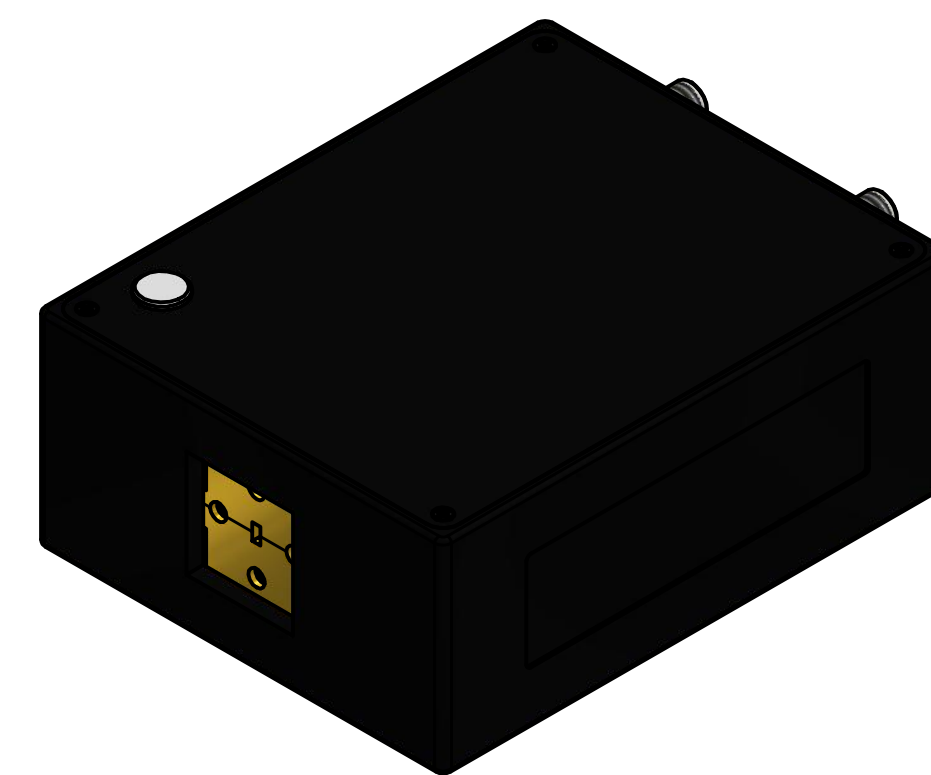

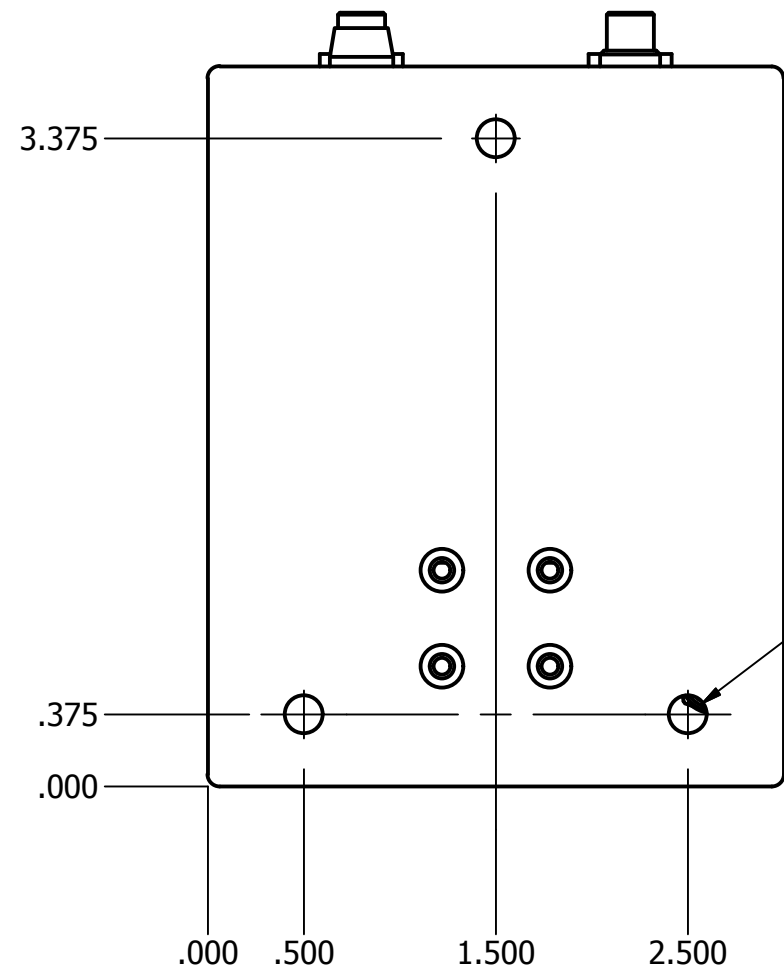
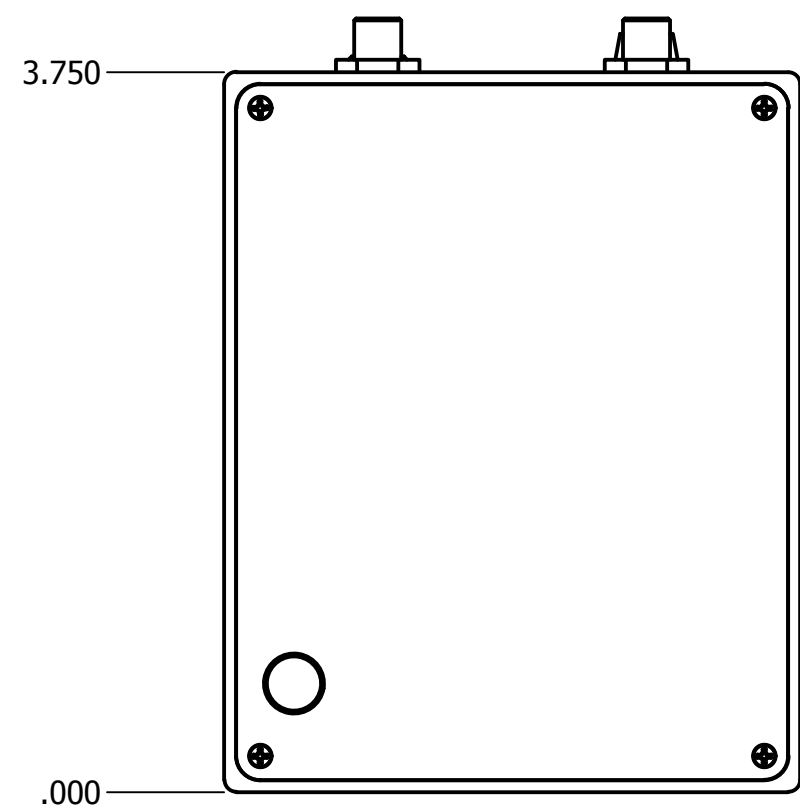

FRONT

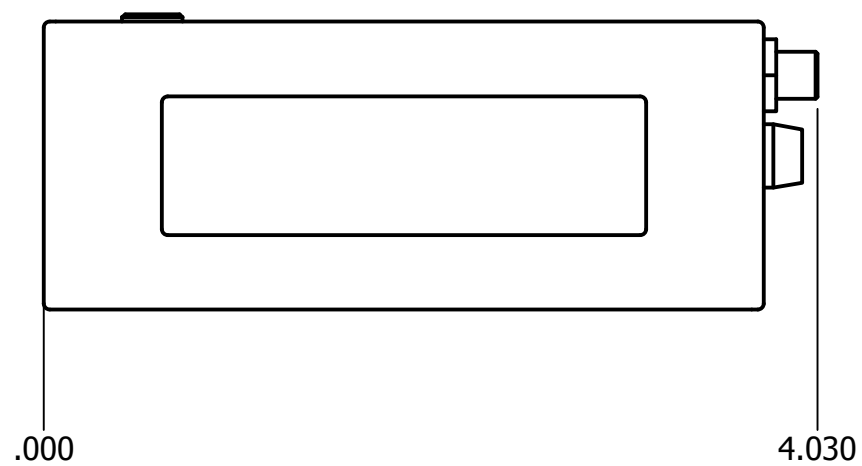
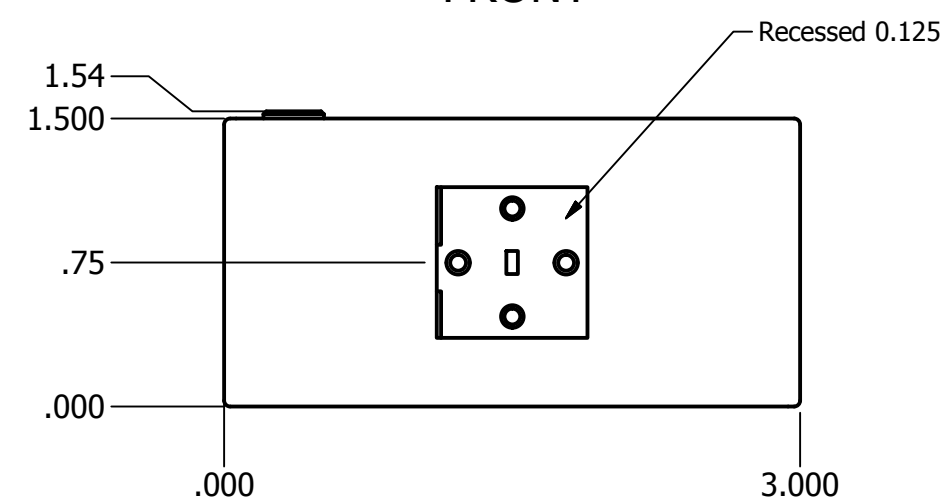
LEFT

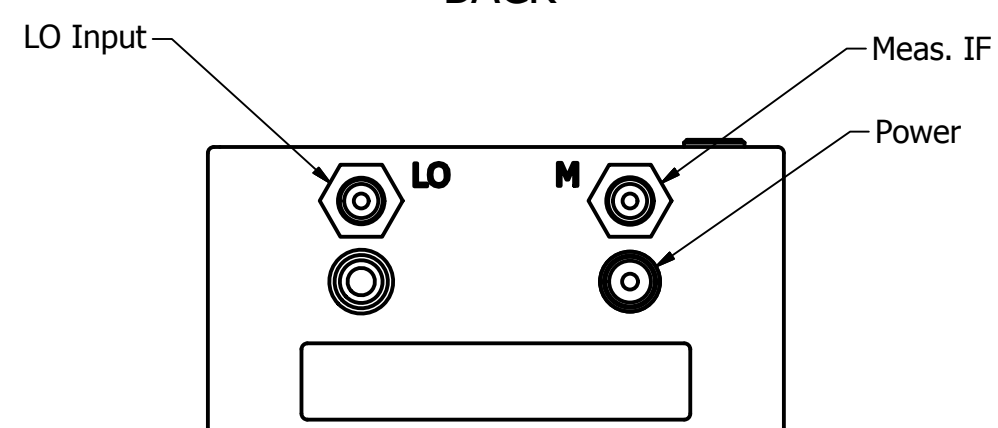

BACK



DRAWN mlambeth CHECKED	10/28/2016	 Virginia Diodes, Inc. 979 Second Street, S.E. Suite 309, Charlottesville, VA 22902
UNLESS OTHERWISE SPECIFIED TOLERANCES X/X = ±1/32 0.00 = ±0.01 0.000 = ±0.0002 0.0000 = ±0.0005 X' = ±0.5'		
TITLE VDIWR12.0CCD Without Footplate		DWG NO VDIWR12.0CCD Without Footplate
SIZE C	SCALE NTS	REV SHEET 1 OF 1