



Mini Spectrum/Signal Analyzer Extension Modules – Operational Manual



979 Second Street SE, Suite 309
Charlottesville, VA 22902-6172 (USA)
Tel: 434.297.3257; Fax: 434.297.3258
www.vadiodes.com

Contents

Section 1 – Introduction	Pages 2-4
Contents	Page 2
SAX-M General Overview	Page 3
Safety and Operational Guidelines	Page 4
Section 2 – Product Views, Block Diagrams and Specifications	Pages 5-9
Major Components and Accessories	Page 5
Module Details – Front and Rear Panel Connections	Page 6
SAX-M Configurations	Page 7
SAX-M Configurations – Continued	Page 8
General Specifications and Technical Notes	Page 9
Section 3 – Operational Procedures	Page 10
General Operational Procedures	Page 10
Appendix 1 – SAX-M SSB Conversion Loss	Pages 11-17
SSB Conversion Loss	Pages 11-17
Appendix 2 – Cable Loss Characterization	Page 18
Cable Loss Characterization Data	Page 18
Appendix 3 – SAX-M Module Drawing	Page 19
Mechanical Drawing – SAX-M Modules	Page 19
Addendum – Product Updates and Company Contacts	Page 20

SAX-M General Overview

Mini Spectrum Analyzer Extension Modules

Virginia Diodes' Mini Spectrum/Signal Analyzer Extension Modules (SAX-Ms) are used to extend the performance of modern spectrum and signal analyzers in the frequency range from 26 GHz through 1.1 THz, in frequency bands from WR28 (26-40 GHz) to WR1.0 (750-1,100 GHz). These modules use VDI's proprietary mixer technology, which achieves low-conversion loss and exceptional sensitivity. Standard features include direct extension of spectrum analyzers and block down-conversion for broadband signal analysis. Additional options include frequency up-conversion, which translates microwave/millimeter-wave signals up to a much higher carrier frequency, and a range of component options that facilitate operation with modern analyzers and/or improve performance for specific applications.



SAX-M Operating Modes

The SAX-M modules can be used in various configurations: Spectrum Analyzer Extension, Block Down-conversion, and Block Up-conversion.

Spectrum Analyzer Extension Mode extends the frequency capability of a modern commercial microwave spectrum analyzer. The internal local oscillator of the spectrum analyzer is used to drive the extension module, allowing use of the spectrum analyzer's data processing to determine the signal's spectrum across the entire waveguide band. This is similar to the function of traditional external mixers, but with greatly improved performance.

Block-Down Conversion Mode converts a block of signal spectrum within the input band of the extension module to a lower frequency, where it can be coupled into the RF port of an analyzer, or processed by other means. In this case, an external synthesizer is used as the LO source for the mixer. By varying the LO frequency, the frequency of the down-converted signal spectrum can be adjusted. The instantaneous bandwidth of the down-converted spectral block can be quite large, as shown in the data tables on Page 10. Block down-conversion maintains the spectral quality of the signal.

Block Up-Conversion Mode up-converts a block of IF signals in the microwave/millimeter-wave band to generate a block of RF signals for transmission. Similar to the down-conversion mode, an external synthesizer is used to drive the module and sets the output frequency. The output signal block is generated in both the upper and lower sidebands of the effective LO frequency at the mixer. Optional output filters are available to eliminate one of these sidebands. Also, amplifiers are available to boost the output power in many of the lower frequency bands.

Safety and Operational Guidelines



Read all instructions and information in this product manual before connecting a module to its power supply or a signal generator. Operational procedures must be followed for proper function. If you have questions, contact VDI before supplying power to a module or otherwise operating any VDI module.



VDI assumes the customer is familiar with microwave, millimeter wave and VDI products in general. The user and customer are expected to understand all safety guidelines, health hazards and general advisories that may exist and are associated with the use of this device. VDI is not responsible for any human hazards that may exist or may occur while using this device.

Input Power Limitations



Recommended input power specifications and limits are noted on the label atop every VDI module and/or in the specification tables on page 9. These values provide optimal performance. Irreversible damage can result if input power exceeds stated damage threshold.

Virginia Diodes, Inc. (VDI) accepts no liability for damage or injury resulting from or caused by:

- Improper use, disassembly or use for other purposes than those for which the module was designed;
- Use outside common safety, health or general advisories pertaining to microwave, millimeter wave and VDI products;
- Repairs carried out by persons other than VDI or its assigned agents;
- Tampering with or altering power cords or other cabling.

Waveguide Inspection / Test Port Care

- Inspect waveguide flanges prior to making connections.
- Extension module waveguide screws should be torqued in the range 20-50 cNm, greater torque can damage the interface.
- Making a connection with metal debris between the waveguide flanges can damage the waveguide interface and prevent repeatable connections.
- If debris is present, clean the flange with pre-dampened TexWipe wipes or swabs (e.g. Part Number TX1065).
- If these are not available, TexWipe cloths lightly dampened with ethanol may be used (e.g. Part Number TX604).
- Replace dust caps when the system is idle.

RF Cable Care

- Use a torque of 90 cNm when making coaxial connections. Avoid sharp bends in cables.

General Operating Practices and Recommendations

- VDI SAX-M Modules are intended to be used in typical laboratory conditions.
- Use of any attachments not authorized by VDI may void a module's limited warranty and could pose a hazard to the operator, or cause lasting damage to the device.
- Use of any attachments and accessories not authorized by VDI or that do not meet VDI's specifications may void the SAX-M's limited warranty and could pose a hazard to the operator, or cause lasting damage to the device.
- DC bias cables provided by VDI must be used. Alternative or replacement cables cannot be used unless the DC cables are adequately rated, properly grounded and authorized for use by VDI.
- Disassembling a module can cause lasting damage to components and pose a hazard to the operator.
- Applying liquids (other than the TexWipe wipes / cloths used for cleaning) can cause lasting damage to the module.
- Check with VDI before any measurement connection is attempted beyond those described in this manual or if it may exceed commonly accepted standards of practice.
- Each VDI module is intended for use only with its AC/DC converter supplied by VDI. Use of other power supplies or converters could damage the device or injure the operator.

Major Components and Accessories

VDI's Spectrum Analyzer Extension (SAX-M) Modules and typical accessories are shown. The exact equipment delivered and especially the input limits (see labels) may vary. The module's input power limits are shown on the attached label and must be complied with to avoid damage and ensure optimal performance. Contact VDI with any questions before powering any module.

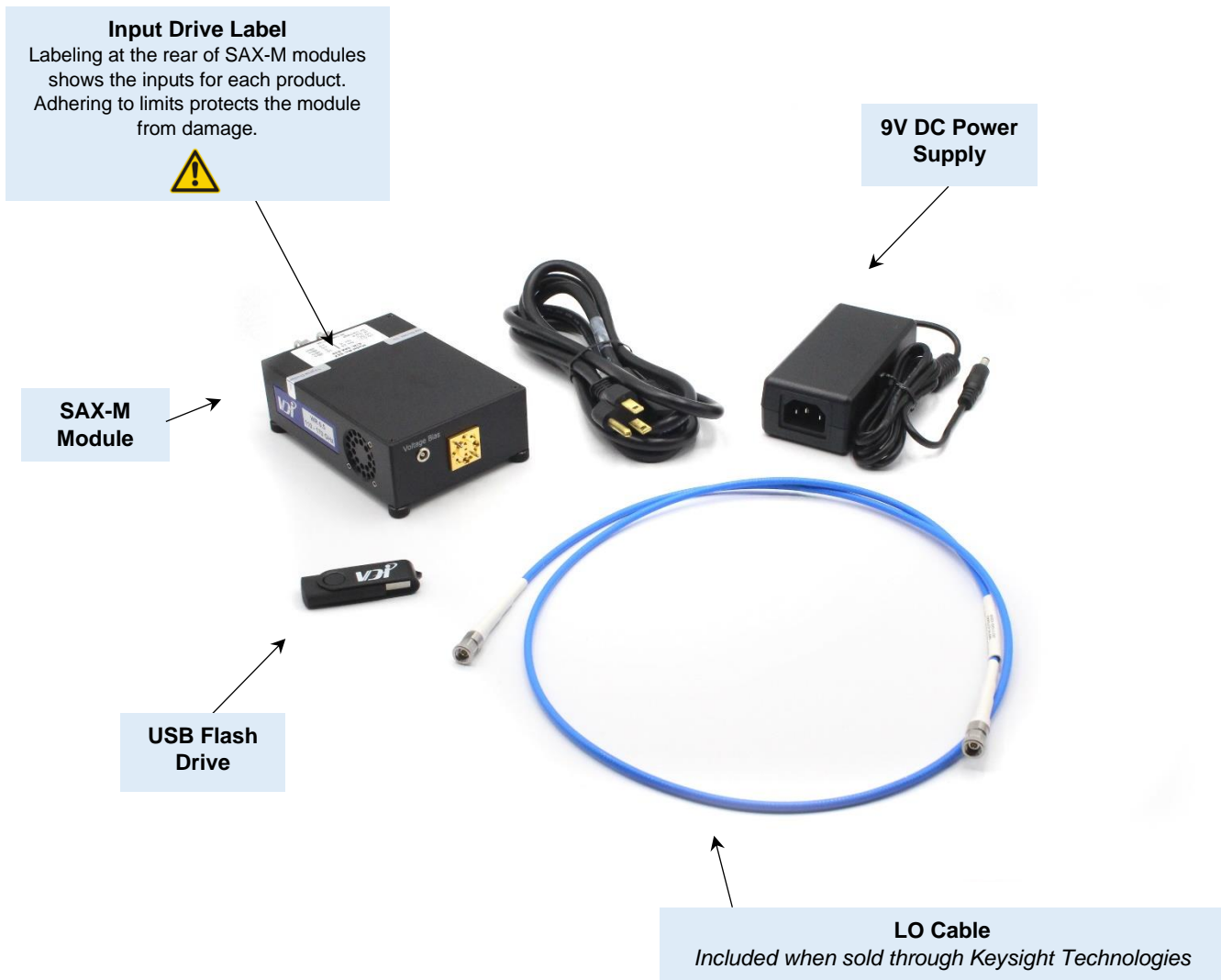

Module Details — Front and Rear Panel Connections

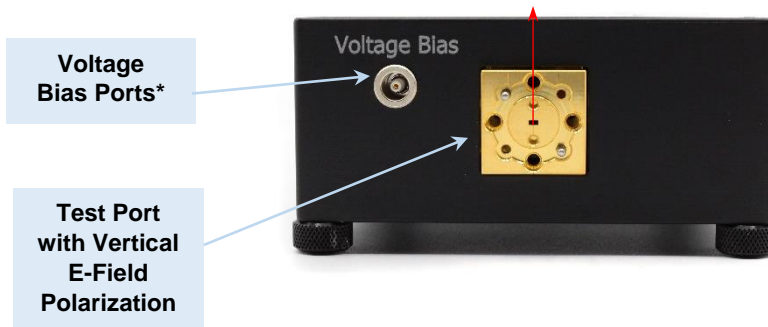

SAX-M – Front Panel

**Voltage Bias Port (+9V) is compatible with external VDI amplifiers.*

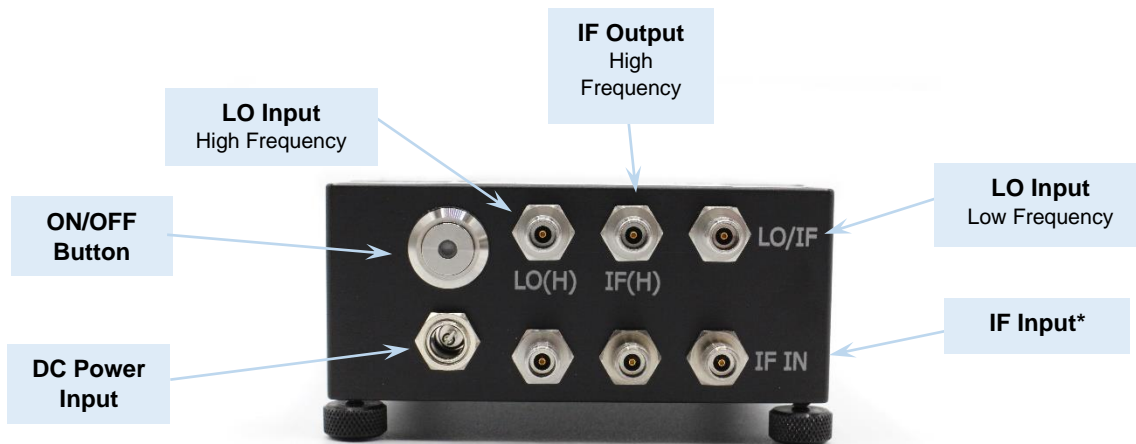

SAX-M – Rear Panel

Applies to all SAX-M modules (IF and LO jumpers not shown). Damage limits listed above are subject to change.

**The IF Input connector is provided only with the Up-Conversion Option.*

SAX-M Configurations

Configuration details for typical SAX-M configurations are shown below. The photographs show proper LO and IF jumper and cable connections. Signal flow block diagrams are also provided. The multiplication factor N, for the LO input frequency, can be found on the Input Drive Label.

CONFIGURATION A: Spectrum Analyzer Extension

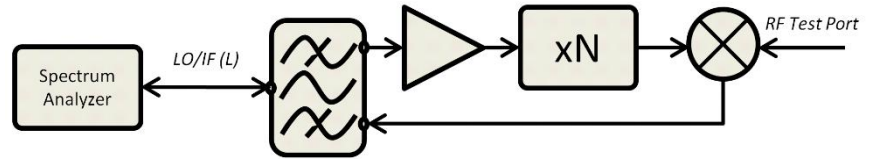

Figure 1: Spectrum Analyzer Extension

Proper configuration details for spectrum analyzer extension are shown. The IF Input Port is not used.

CONFIGURATION B: Block Down-Conversion (Low Frequency LO Input)

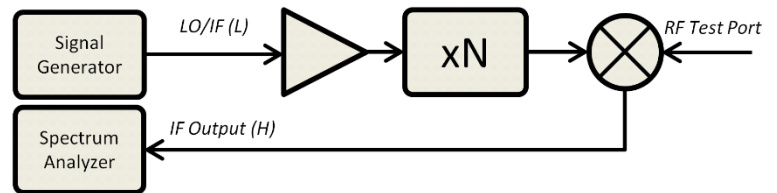

Figure 2: Block Down-Conversion – Low Frequency LO Input

Proper configuration details for down-conversion using the low frequency input port are shown. The IF Input Port is not used.

SAX-M Configurations – Continued

CONFIGURATION C: Block Down-Conversion (High Frequency LO Input)

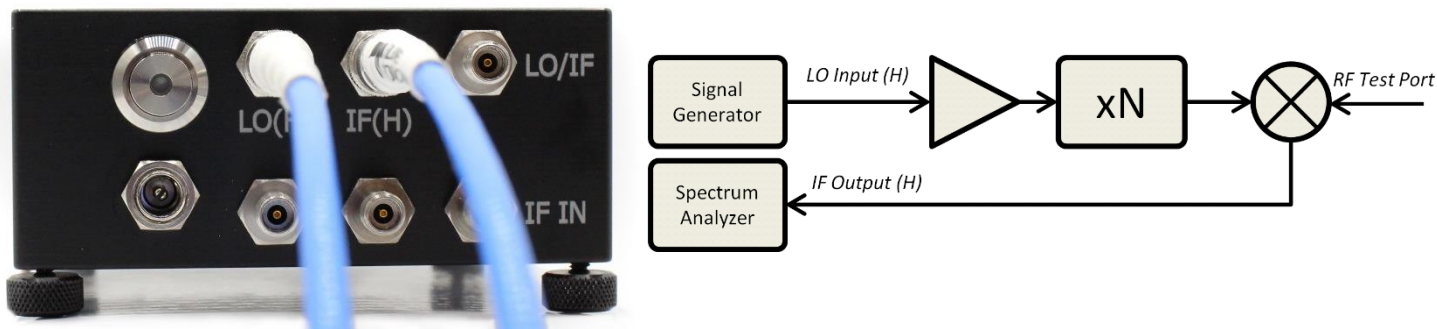

Figure 3: Block Down-Conversion – High Frequency LO Input
Proper configuration details for down-conversion using the high frequency LO input port are shown. The IF Input Port is not used.

CONFIGURATION D: Block Up-Conversion

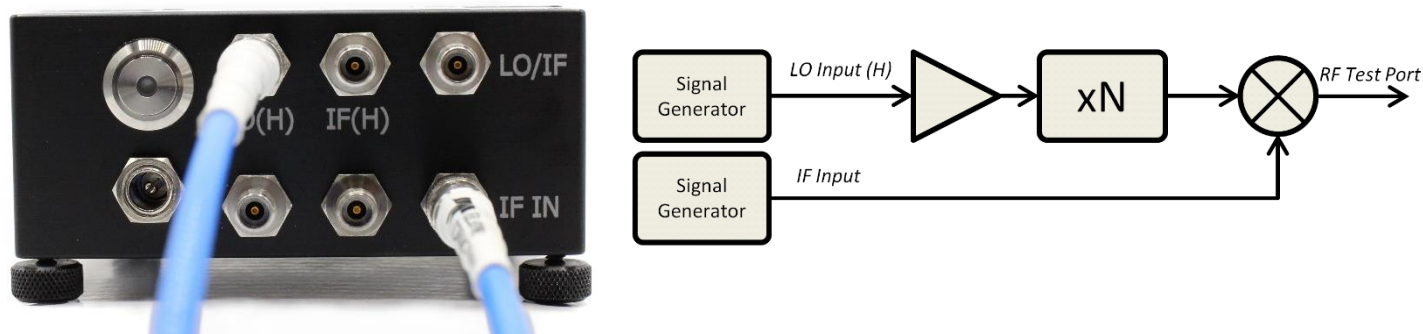



Figure 4: Block Up-Conversion
Proper configuration details for up-conversion are shown. The IF Output (H) Port is not used.

General Specifications and Technical Notes

Table 1: General Specifications for VDI SAX-M Modules

Description		Specification	Connector
LO Input Port	Low Frequency (Typical / Damage)	10 dBm ± 3dB / 18 dBm	2.92mm (f)
	High Freq. (Typical / Damage)	0 dBm ± 3dB / 6 dBm	2.92mm (f)
Low Freq. IF Output Port	WR28 to WR1.0 (Typical)	~50kHz-2.5GHz	2.92mm (f)
High Freq. IF Output Port	Start Frequency (Typical)	~50kHz	2.92mm (f)
	Stop Frequency	See Below	
RF Test Port	VDI Precision Flange	WR15 to WR1.0	UG-387/UM
		WR28 to WR19	UG-599/UM
AC Inputs	Single-Volt Power Supply (+9V / 4A)	100-240VAC, 3.5A, 50-60Hz	U.S. or E.U.
Maximum Weight	--	2.0 Lbs. (0.90 Kg.)	--
Dimensions	Typical (Length x Width x Height)	6" x 3.5" x 1.5"	--
Operating Temperature	Typical / Recommended	25°C / 20-30°C	--

Standard: LO Input
N=24 Power = 10dBm
High: LO Input
N=6 Power = 0dBm
Up Conversion: IF Input
Power < 0dBm



Virginia Diodes, Inc.
www.vadiodes.com

Input Drive Labels
Follow the inputs listed on Extension Module labels to avoid damage. Values shown here are only examples.



Table 2: VDI Mini Spectrum/Signal Analyzer Extension Module Specifications

Description	WR28	WR19	WR15	WR12	WR10	WR8.0	WR6.5	WR5.1
RF Frequency Band (GHz)	26-40	40-60	50-75	60-90	75-110	90-140	110-170	140-220
RF Power Limits (Compression / Damage, typ.)	-4 / 6	-10 / 0	-10 / 0	-10 / 0	-10 / 0	-10 / 0	-10 / 0	-10 / 0
Intrinsic Mixer Conversion Loss (dB, typ.)*	9	9	10	10	10	10	10	11
High Freq. IF Output, Stop Frequency (GHz, typ.)	4	6	7.5	9	11	14	17	22
IF Input Frequency – with -UP Option, Up-Conversion (GHz, typ.)	1-4	1-6	1-7.5	1-9	1-11	1-14	1-17	1-20
Displayed Average Noise Level (dBm/Hz, typ.)†	-150	-150	-150	-150	-150	-150	-150	-150
Description	WR4.3	WR3.4	WM710 (WR2.8)	WM570 (WR2.2)	WM380 (WR1.5)	WM250 (WR1.0)		
RF Frequency Band (GHz)	170-260	220-330	260-400	330-500	500-750	750-1,100		
RF Power Limits (Compression / Damage, typ.)	-10 / 0	-10 / 0	-10 / 0	-10 / 0	-10 / 0	-20 / -10		
Intrinsic Mixer Conversion Loss (dB, typ.)*	11	12	13	14	18	25		
High Freq. IF Output, Stop Frequency (GHz, typ.)	26	40	40	40	40	40		
IF Input Frequency – with -UP Option, Up-Conversion (GHz, typ.)	1-20	1-20	1-20	1-20	1-20	1-20		
Displayed Average Noise Level (dBm/Hz, typ.)†	-150	-150	-150	-150	-150	-140		

*Intrinsic Mixer Conversion loss is measured from the RF Test Port to Mixer IF Port at 322.5 MHz before any IF amplification. Mixer IF Port cannot be accessed by user.

†Displayed Average Noise Level (DANL) measurements taken on Keysight PXA based on compression levels listed above. For small signal analysis, DANL can be enhanced with external IF amplification. Contact VDI for more information.

Options List:

- IF Input Port for Block Up-Conversion, with optional filters and power amplifiers
- External Micrometer Driven Attenuator (~0-30 dB)
- Horn Antenna
- Waveguide Test Port Extensions (1" and 2" available)
- High Sensitivity Option (For small signal levels the DANL can be enhanced by additional IF amplification. Contact VDI for more information).

General Notes:

- Conversion loss is measured at IF of 322.5 MHz (RF>LO), loss increases at a rate of about ~1.5dB/10GHz up to the specified maximum IF.
- All models include a ~50kHz-40 GHz IF amplifier. Noise Figure of IF Amplifier degrades significantly below ~50 MHz.

The safety and operational guidelines are listed on page 4. VDI recommends the following general operating procedures for using these products with optimal performance.

Turn-On Procedure

- 1) Setup any appropriate instrument (signal generators, spectrum analyzers, etc.) in accordance with the manufacturer's operating manuals.
- 2) Connect the DC Power Supply to the module.
- 3) Make all necessary connections (i.e. RF, LO, IF) as shown in Figures 1-4.
- 4) Turn 'ON' the small signal RF input power, or IF input power for up-conversion.

Turn-Off Procedure

- 1) Turn 'OFF' the small signal RF input power, or IF input power for up-conversion.
- 2) Turn 'OFF' the LO input power.
- 3) Disconnect the DC Power Supply from the module.
- 4) It is now safe to turn off all other equipment on user test bench.

Guidelines for Configuration A: Spectrum Analyzer Extension

- For this configuration, the VDI SAX-M module is used in the same manner as a traditional external mixer.
- Therefore, the spectrum analyzer must have the external mixer option with an LO output signal that is consistent with the Low Frequency LO input requirements of the SAX-M module. Refer to Spectrum Analyzer manual as needed.
- Signal Identification and/or Image Suppression may be used to reduce the number of spurious signals.
- VDI recommends setting the spectrum analyzer to the maximum number of points for initial verification. Number of points may be reduced after module performance has been verified.
- The 'PXA Table' file is intended to be used with Keysight Spectrum Analyzers (EXA, MXA, PXA, UXA, etc). The 'Conversion Loss' file provides conversion loss data for various SAX-M configurations. When using the VDI SAX-M modules with other spectrum analyzers, please use the correct conversion loss data in a file format that is compatible with the spectrum analyzers.

Guidelines for Configuration B and C: Block Down-Conversion

- Attenuation between the SAX-M module and customer spectrum analyzer (or similar instrument) may be necessary to avoid saturation or damage of the instrument. Refer to saturation and damage limits in manufacturer's operating manual.
- The input LO frequency should be greater than the maximum IF frequency used, in order to prevent regeneration of the LO signal in the IF Output.
- If possible, the high frequency LO input should be used to reduce spurious signals in the IF Output.
- VDI provides a CSV file on the USB drive that contains a table of conversion loss data from the RF Test Port to the IF Output (H), measured at an IF of 322.5 MHz.

Guidelines for Configuration D: Block Up-Conversion

- For up-conversion, the IF input power limits are 20dB greater than the RF Power Limits in Table 2.
- At the RF output port, two sidebands will be generated and RF frequencies can be calculated by using the following relationships: $RF_{lower} = n*LO - IF$ and $RF_{upper} = n*LO + IF$.
- External filters can be used to reject the undesired sideband. Contact VDI for more information.
- External amplifiers can be used to increase the RF output power. Contact VDI for more information. (Bias ports on front panel are used to supply appropriate bias voltage to VDI amplifiers).
- The input LO frequency should be greater than the maximum IF frequency used, in order to prevent regeneration of LO signal in the RF Output.
- If possible, the high frequency LO input port should be used to reduce spurious signals in the RF Output at the test port.
- Up-conversion loss from the IF Input Port to the RF Test Port is approximately 20dB more than the intrinsic mixer conversion loss. The intrinsic mixer conversion loss data is provided in the CSV file.

Typical Single Side Band (SSB) Intrinsic Mixer Conversion Loss plots are provided on the following pages, starting with WR28 SAX-M and ending with WR1.0 SAX-M. This is the conversion loss of the mixer before any IF amplification. Note, the user does not have direct access to the mixer, but this data is useful to understand the quality of the mixer.

SSB Conversion Loss

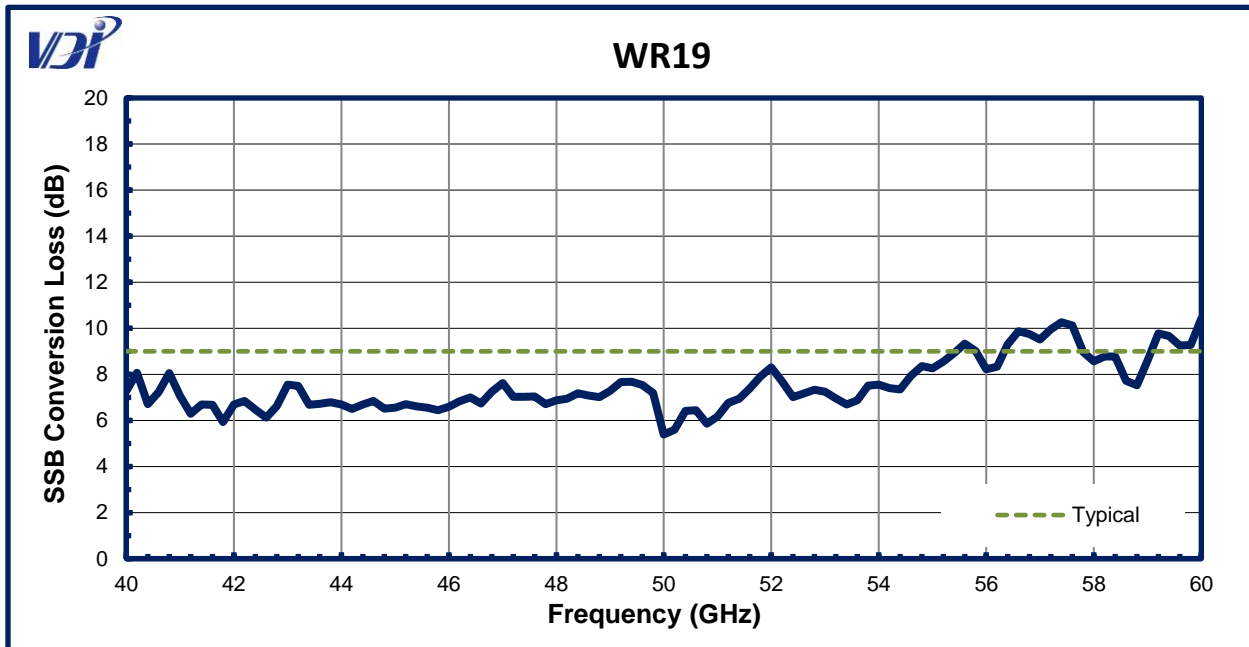
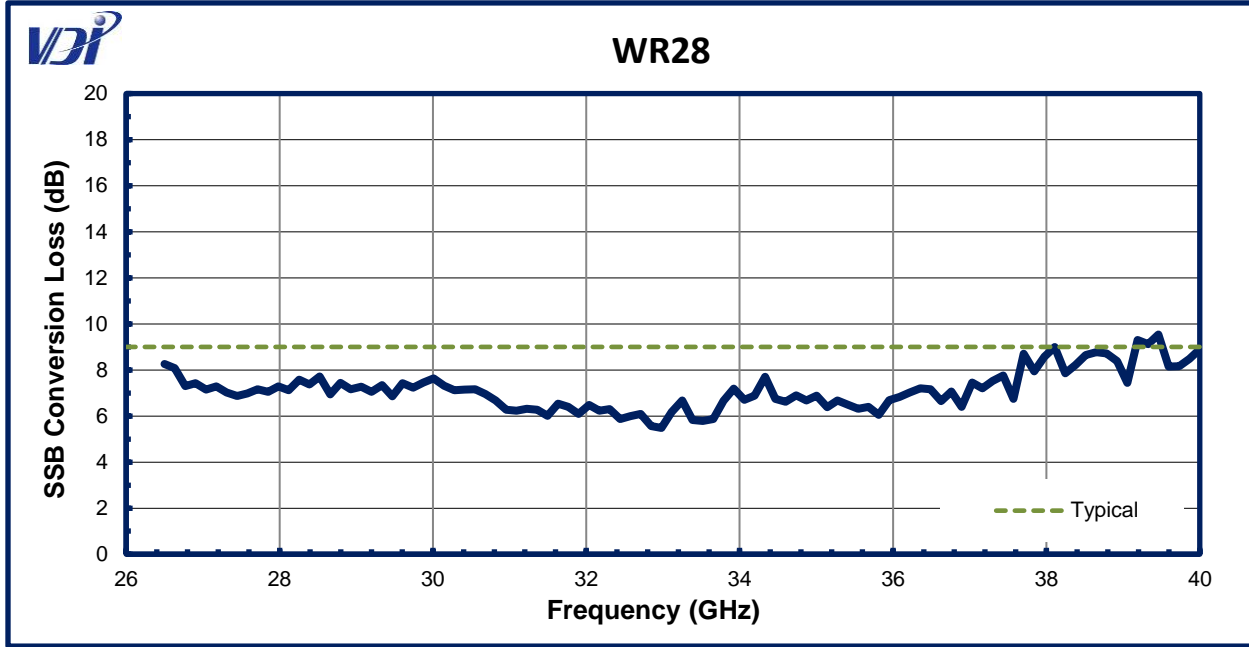

SAX-M SSB Conversion Loss

SAX-M Performance — Continued

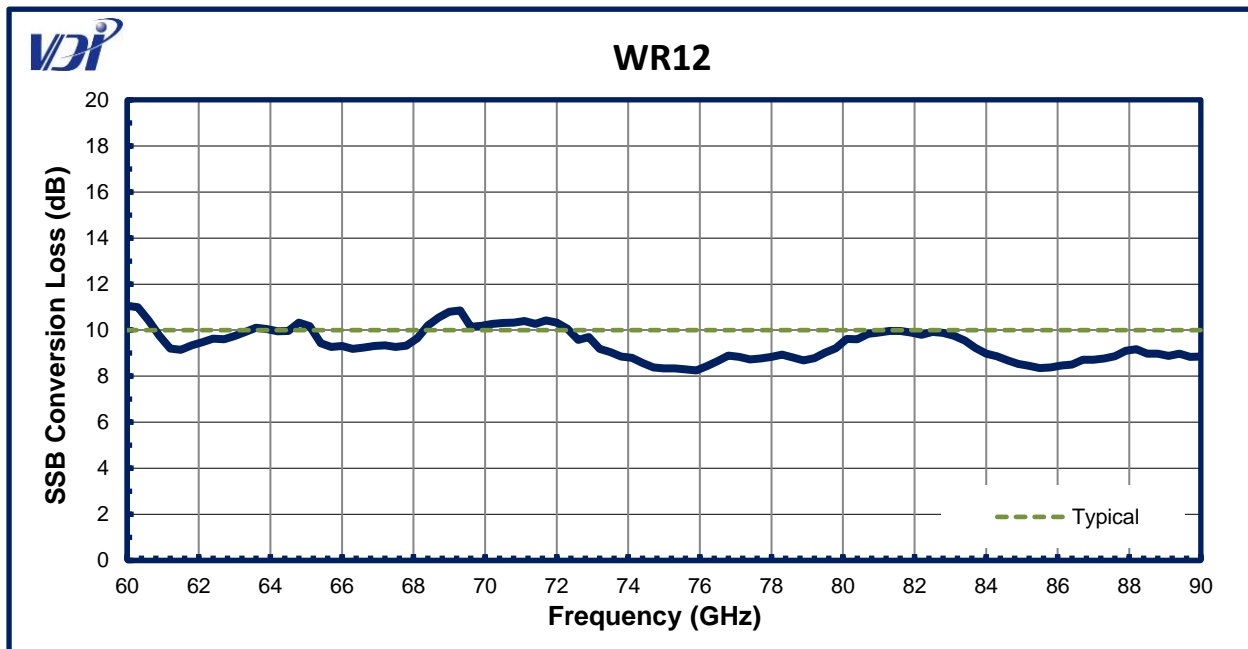
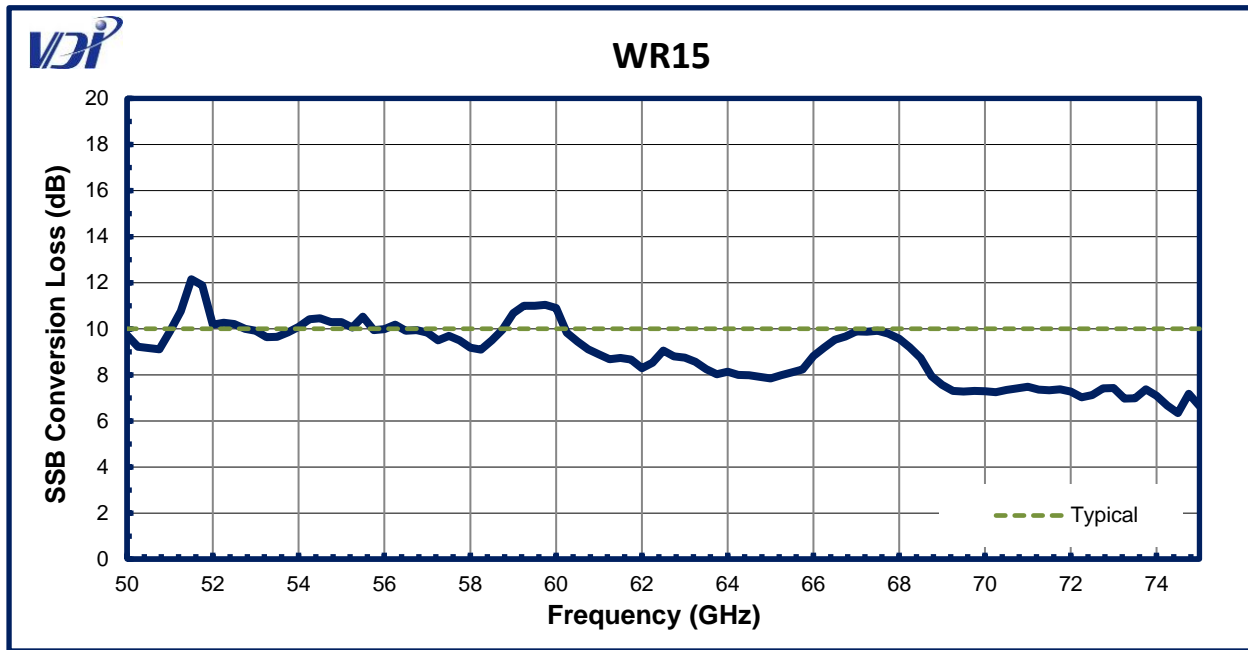

SAX-M SSB Conversion Loss

SAX-M Performance — Continued

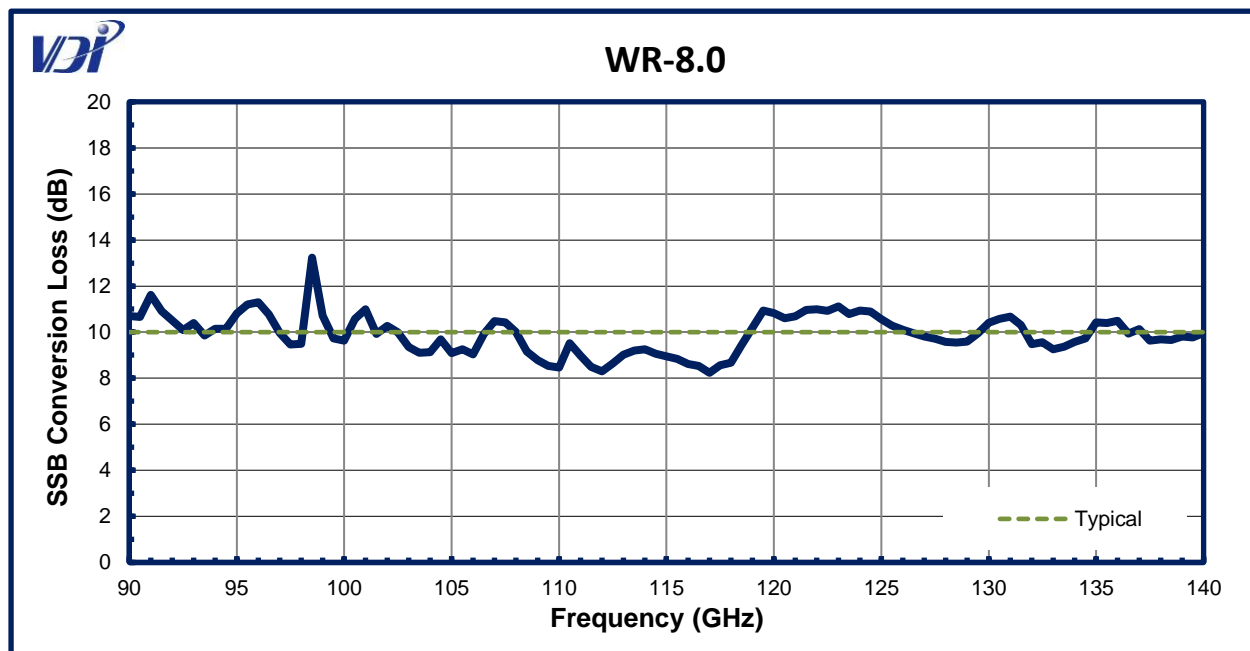
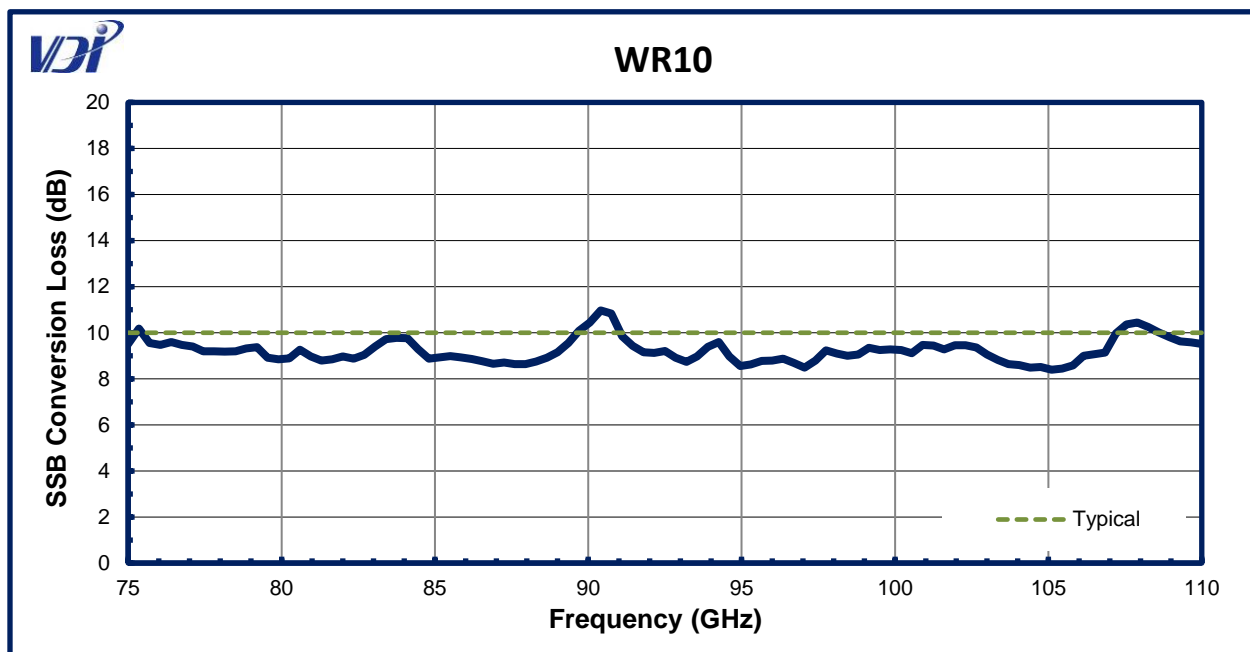

SAX-M SSB Conversion Loss

SAX-M Performance — Continued

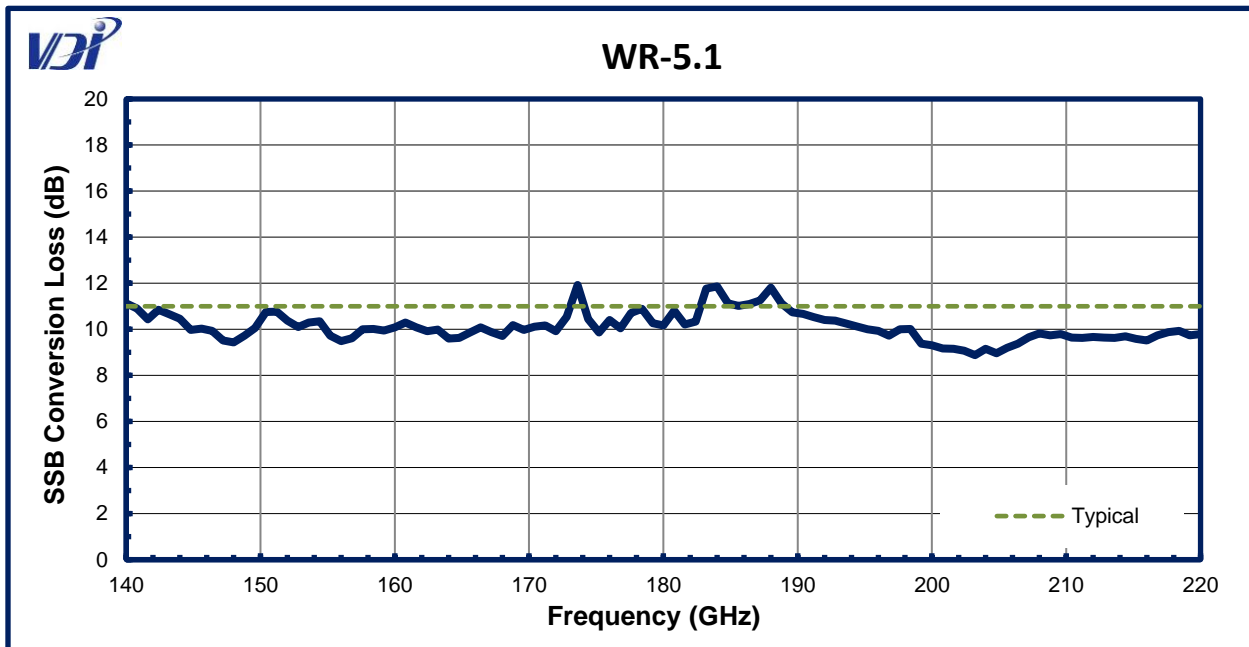
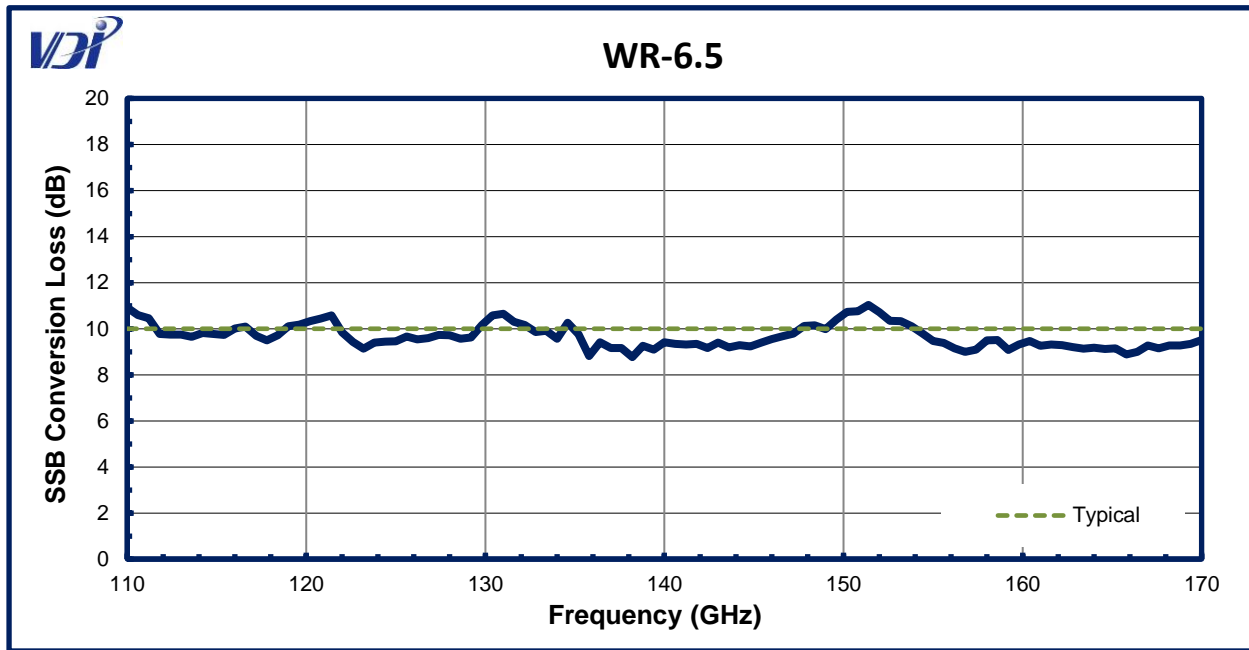

SAX-M SSB Conversion Loss

SAX-M Performance — Continued

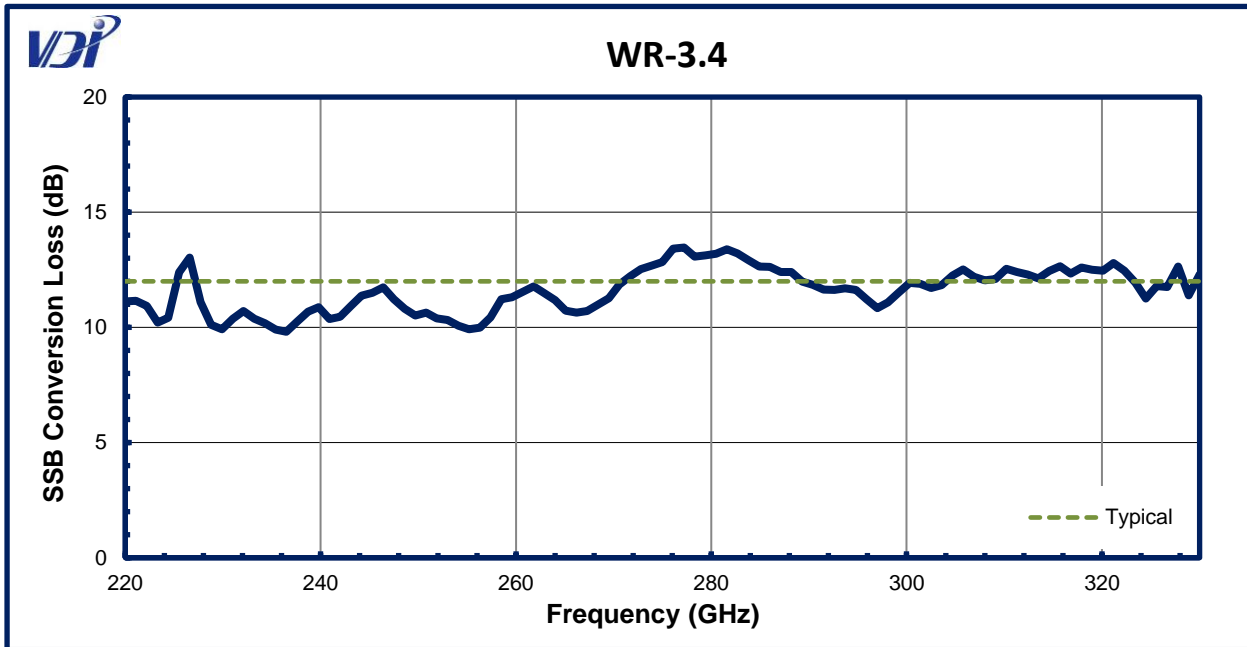
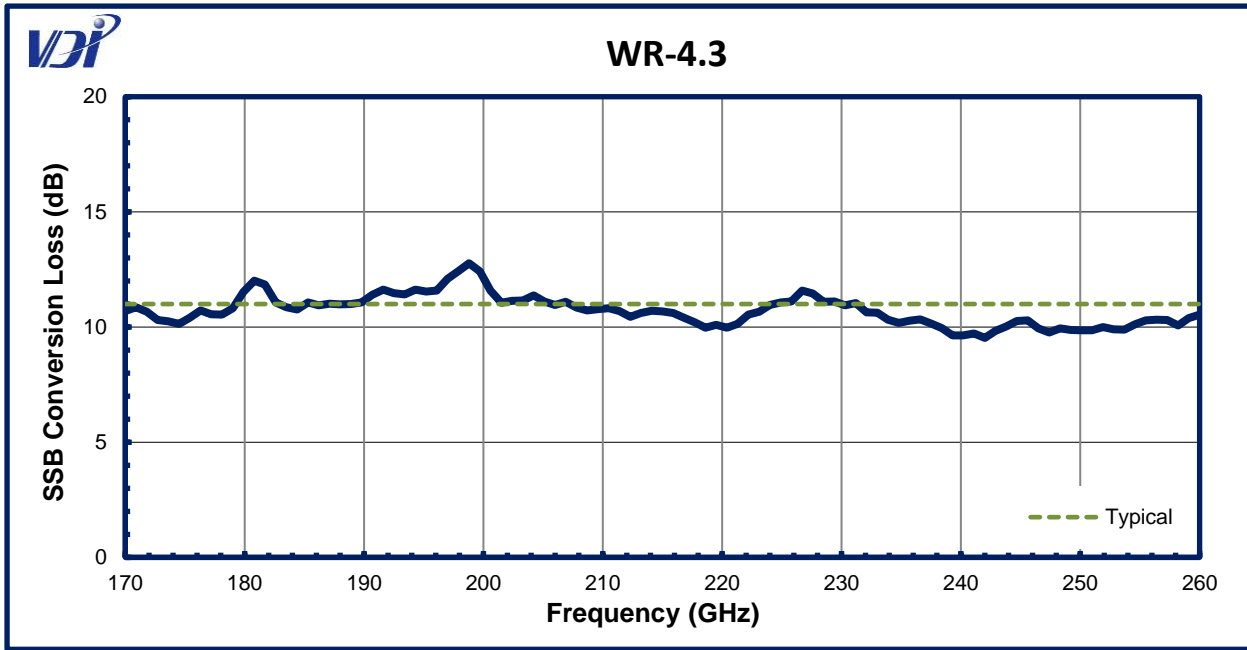

SAX-M SSB Conversion Loss

SAX-M Performance — Continued

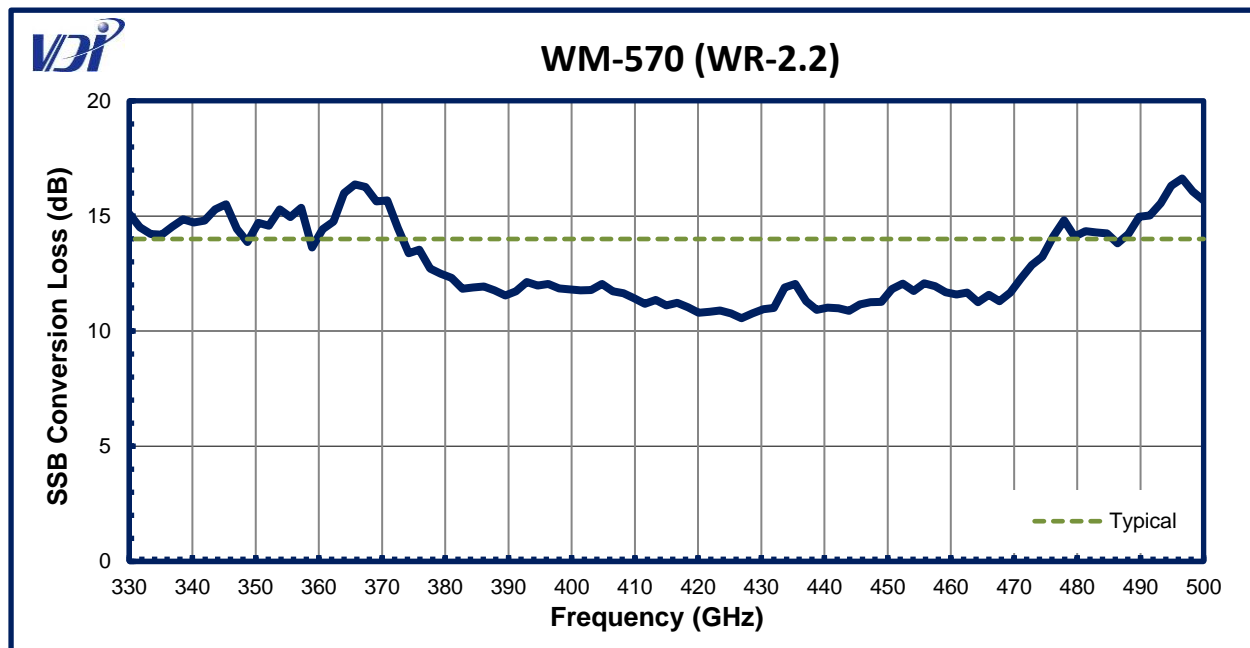
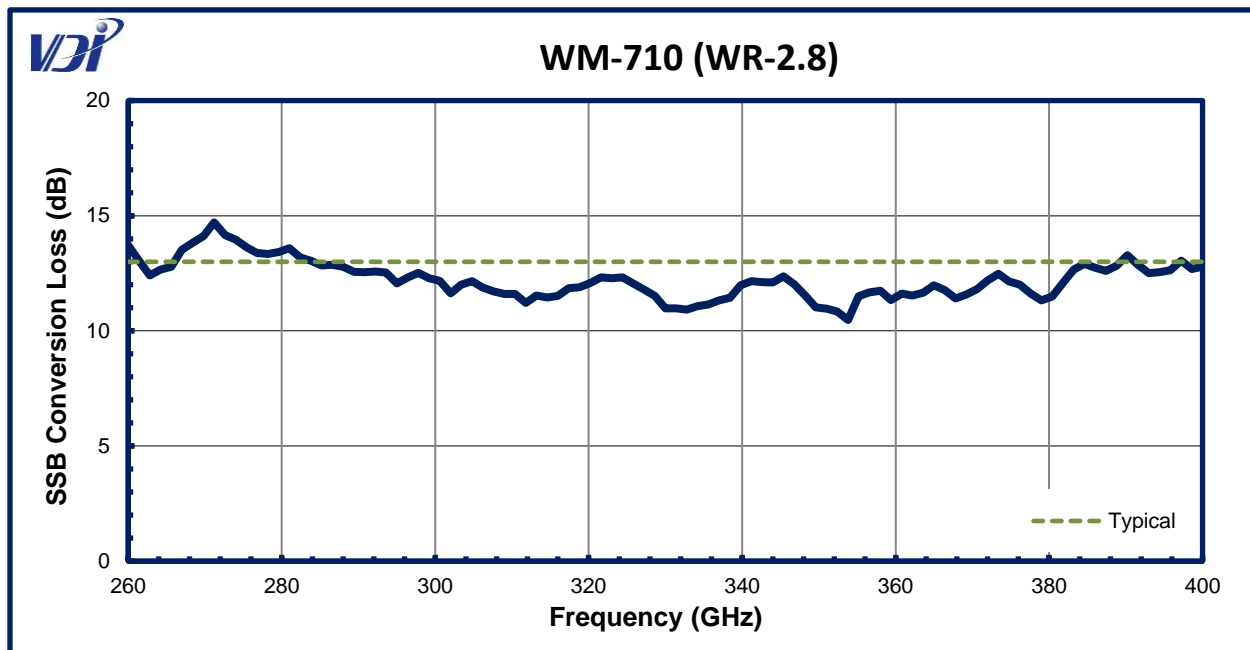

SAX-M SSB Conversion Loss

SAX-M Performance — Continued

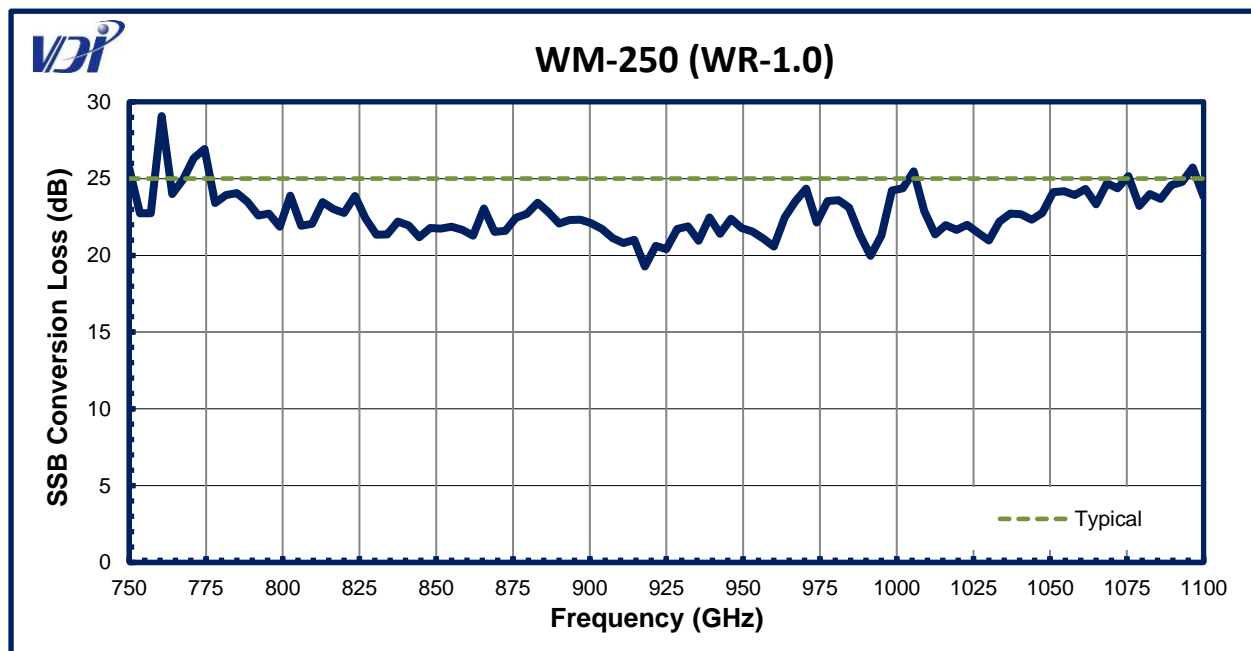
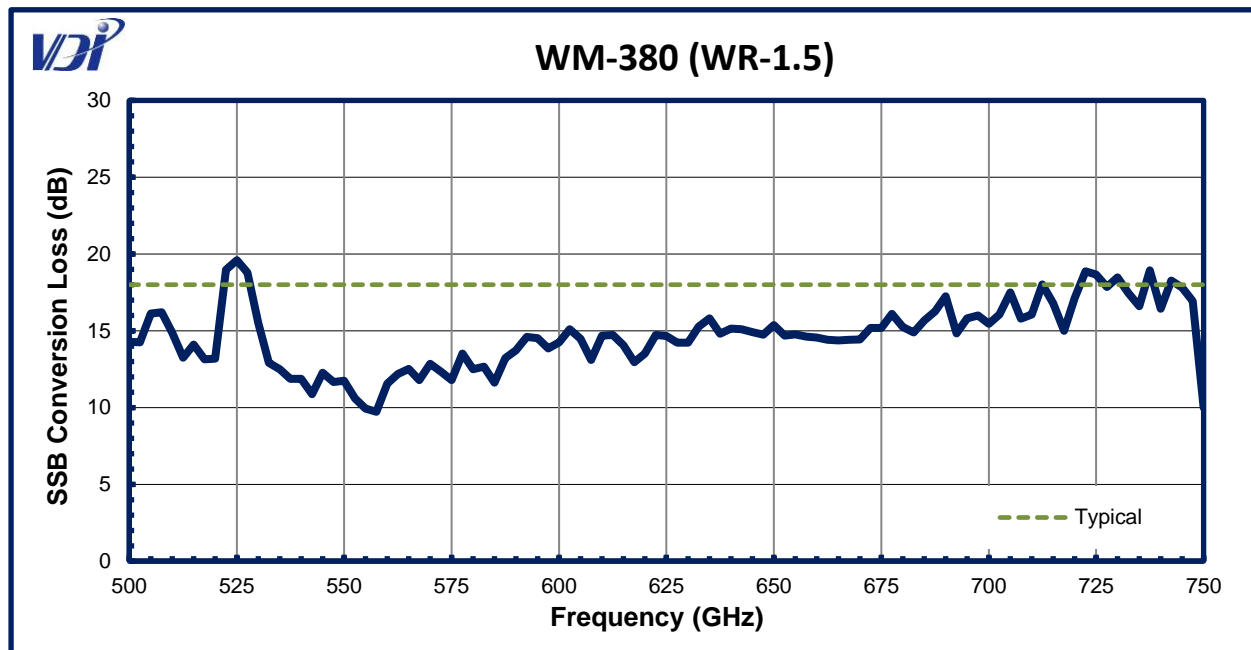

Cable Loss Characterization Data

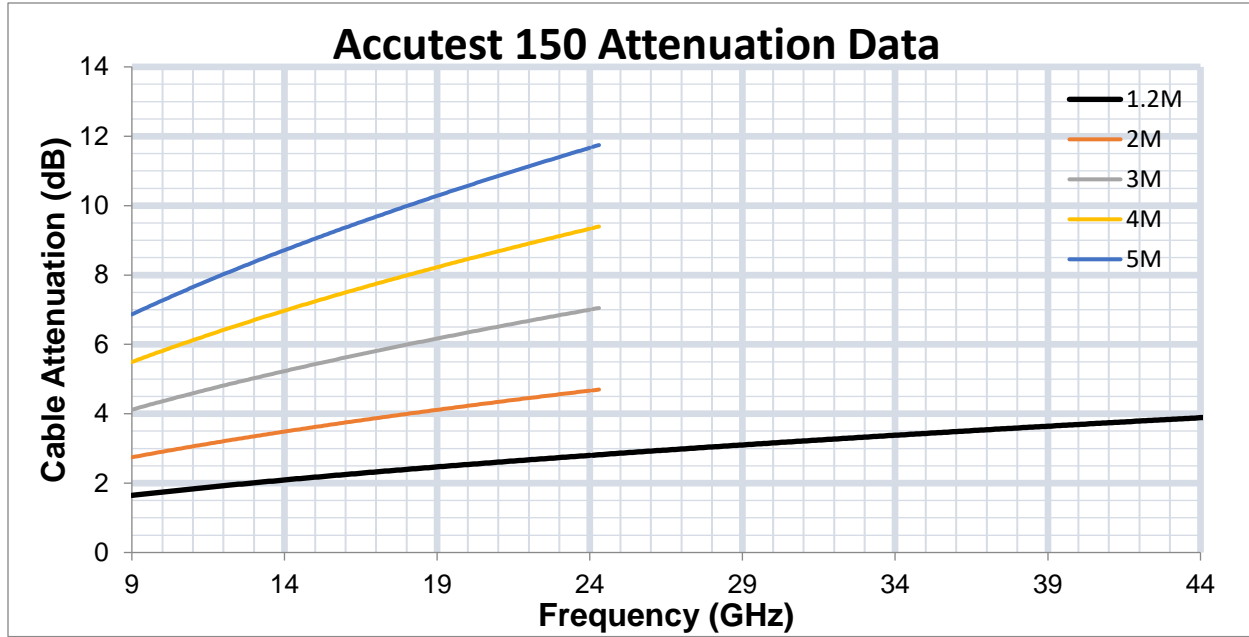

Figure 5:

Typical insertion loss of Accutest 150 (LO Cable) with respect to frequency. This chart can be used to estimate cable losses in your system.

Mechanical Drawing – This drawing applies to all SAX-M modules.

This applies to Mini SAX Modules with Serial Number 900 or later. Earlier versions of the Mini SAX Module have 5.0" x 3.5" x 1.5" form factor. See VDI website for 2D drawings on both new and old form factors.

THE INFORMATION CONTAINED IN THIS DOCUMENT IS THE PROPRIETARY PROPERTY OF VIRGINIA DIODES, INC.

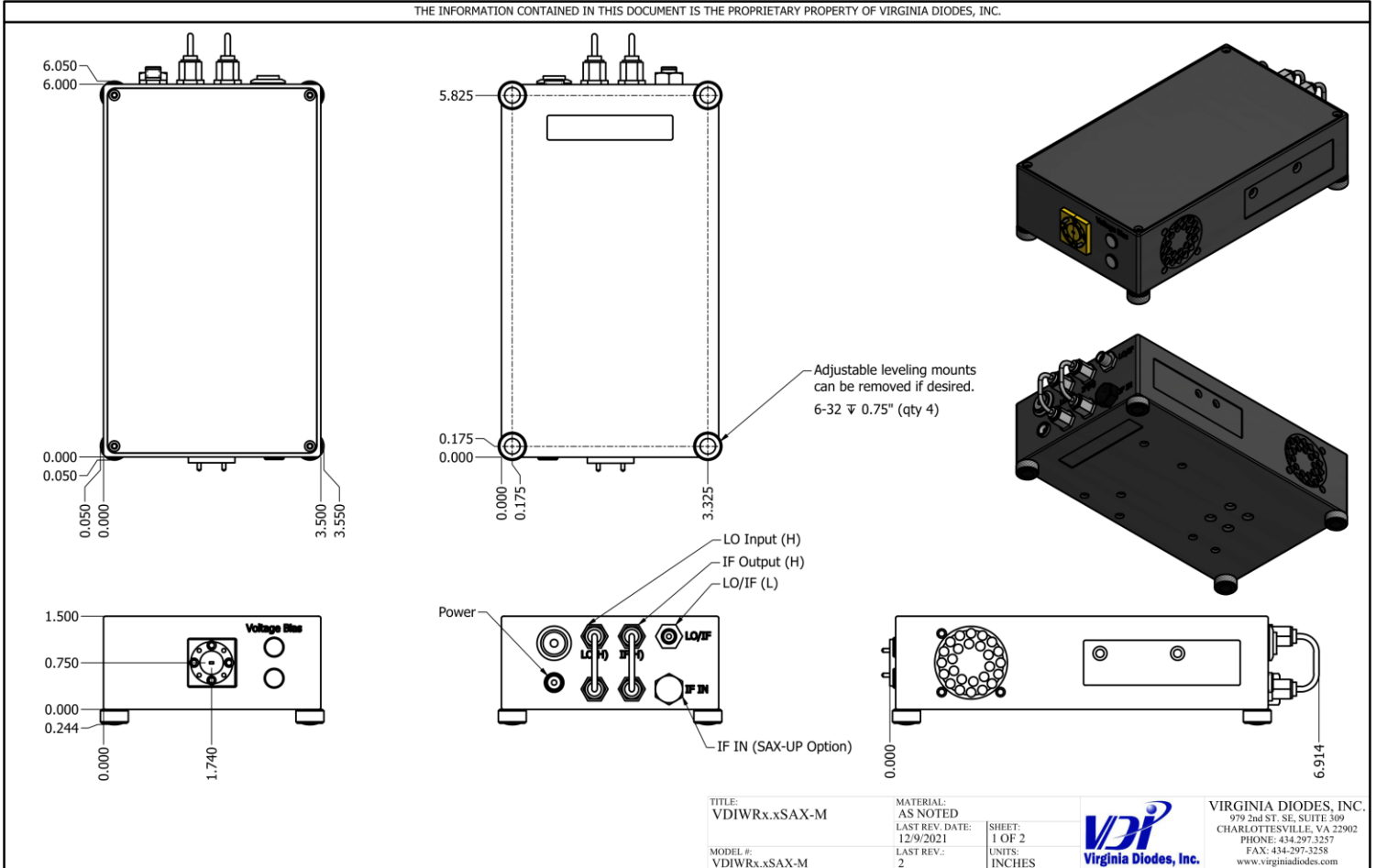

TITLE: VDIWRx.xSAX-M	MATERIAL: AS NOTED	SHEET: 1 OF 2
LAST REV. DATE: 12/9/2021	LAST REV.:	UNITS: INCHES
MODEL #: VDIWRx.xSAX-M	2	



VIRGINIA DIODES, INC.
979 2nd ST. SE. SUITE 309
CHARLOTTESVILLE, VA 22902
PHONE: 434.297.3257
FAX: 434.297.3258
www.virginiadiodes.com

Addendum — Product Updates and Company Contacts



Virginia Diodes' SAX-M modules provide high performance broadband down-conversion, up-conversion and frequency extension of microwave spectrum analyzers into the THz range. VDI SAX-M modules offer full waveguide band coverage and are available from WR28 (26-40 GHz) to WM-250 (750-1100 GHz). Additional bands are under development.

The Virginia Diodes staff of engineering and physical science professionals works to continually improve our products. We also depend upon feedback from colleagues and customers. Ideas to simplify Extension Module operations, improve performance or add capabilities are always welcome. Be certain that Virginia Diodes has your latest contact details including a phone number and an email address to receive update advisories.

Contact VDI:

Virginia Diodes, Inc.

Web: <http://www.vadiodes.com>

Email: Technical@vadiodes.com

Telephone: 434.297.3257