

STA-40-34-F1

WR-34 Band Fixed Attenuator, 40 dB

STA-40-34-F1 is a 40 dB fixed attenuator that is used in millimeterwave systems and operates from 22 to 33 GHz. The attenuator has a fixed attenuation value of 40 dB at center frequency, 27.5 GHz. The attenuator's waveguides are manufactured with precision wire EDM to ensure high accuracy and a quality internal surface finish. The design features a sandblasted surface treatment to provide a durable finish. While the attenuator is designed for full waveguide band applications, the attenuation value does show a minor slope within the band due to its distinct mechanical configuration. Other attenuation values are available under different model numbers as **STA-XX-34-F1**, where **XX** is the desired attenuation value.



Electrical Specifications:

Parameter	Minimum	Typical	Maximum
Frequency Range	22 GHz		33 GHz
Attenuation Range @ 27.5 GHz		40 dB	
Return Loss		20 dB	
Power Handling		750 mW	1000 mW (CW)
Specification Temperature		+25°C	
Operating Temperature	-40°C		+85°C

Mechanical Specifications:

Item	Specification
Waveguide Ports	WR-34 Waveguide with UG-1530/U Flange
Attenuation Setting	Fixed
Insertion Length	4.00"
Material	Brass
Finish	Gold Plated
Weight	6.0 Oz
Outline	TA-F3

ECCN

EAR99

FEATURES

- Full Band Coverage
- Low Cost
- Accurate Attenuation Value at Center Frequency

APPLICATIONS

- Test Lab
- Instrumentations
- System Integration

SUPPLEMENTAL DETAILS



Typical Measured Attenuation vs Frequency

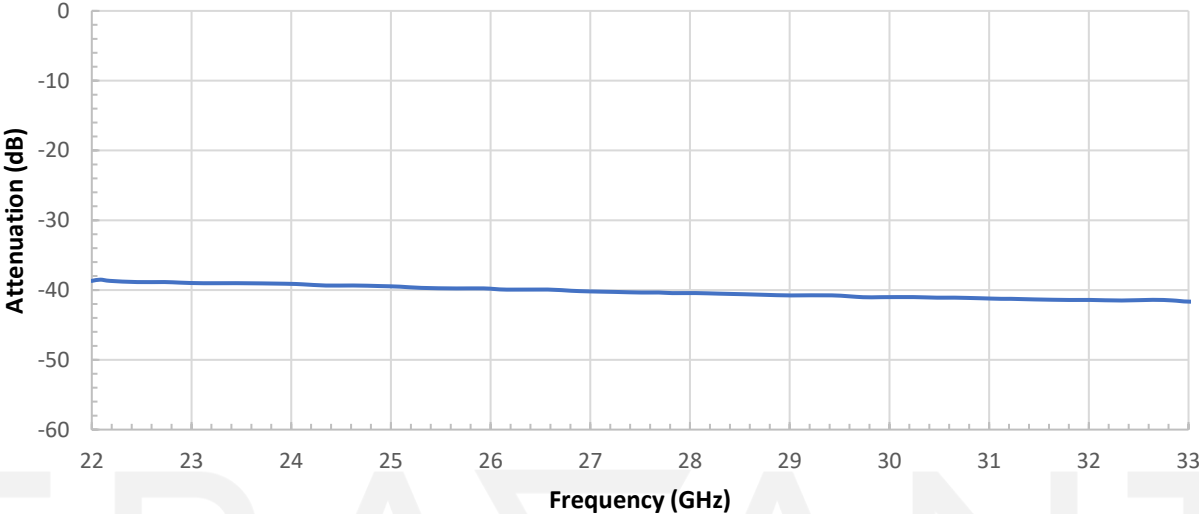

Mechanical Outline: (Unless otherwise specified, all dimensions are in inches [millimeters])

MAKING MILLIMETERWAVE ACCESSIBLE

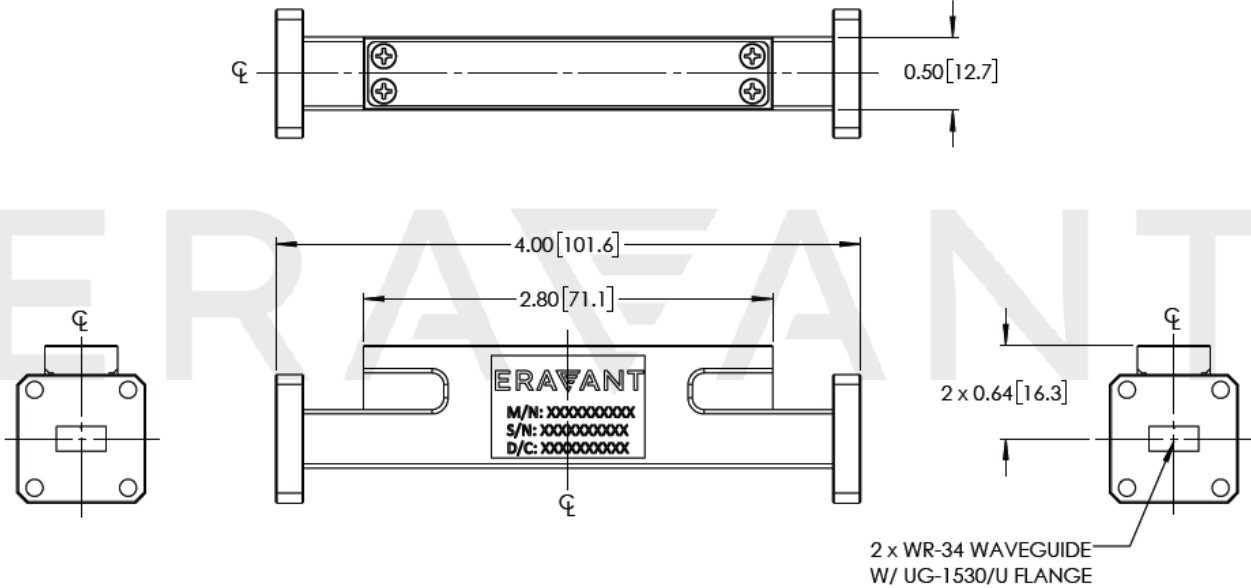

NOTE:

- All data presented is collected from a sample lot. Actual data may vary unit to unit, slightly.
- All testing was performed under +25 °C case temperature.
- Eravant reserves the right to change the information presented without notice.

CAUTION:

- Exceeding absolute maximum ratings will damage the device.
- Any foreign objects in the waveguide will cause performance degradation and may damage the device.

ERAVANT
MAKING MILLIMETERWAVE ACCESSIBLE

ERAVANT
MAKING MILLIMETERWAVE ACCESSIBLE