



Q-Band Fixed Attenuator, 40 dB Attenuation

Description:

Model STA-40-22-F1 is a 40 dB fixed attenuator that is used in millimeterwave systems and operates from 33 to 50 GHz. The attenuator has a fixed attenuation value of 40 dB at center frequency, 41.5 GHz. The attenuator's waveguides are manufactured with precision wire EDM to ensure high accuracy and a quality internal surface finish. The design features anti-cocking flanges to reduce misalignment errors and a sandblasted surface treatment to provide a durable finish. While the attenuator is designed for full waveguide band applications, the attenuation value does show a minor slope within the band due to its distinct mechanical configuration. Other attenuation values are available under different model numbers as **STA-XX-22-F1**, where **XX** is the desired attenuation value.



Features:

- Full Band Coverage
- Low Cost
- Accurate Attenuation Value at Center Frequency

Applications:

- Test Lab
- Instrumentations
- System Integration

Electrical Specifications:

Parameter	Minimum	Typical	Maximum
Frequency Range	33 GHz		50 GHz
Attenuation @ 41.5 GHz		40 dB	
Return Loss		20 dB	
Power Handling		500 mW	750 mW
Specification Temperature		+25 °C	
Operating Temperature	-40 °C		+85 °C

Mechanical Specifications:

Item	Specification
Waveguide Ports	WR-22 Waveguide with UG-383/U Anti-Cocking Flange
Attenuation Setting	Fixed
Insertion Length	3.00"
Material	Brass
Finish	Gold Plated
Weight	4.5 Oz
Outline	TA-FQ-A



Q-Band Fixed Attenuator, 40 dB Attenuation

Typical Measured Attenuation vs Frequency

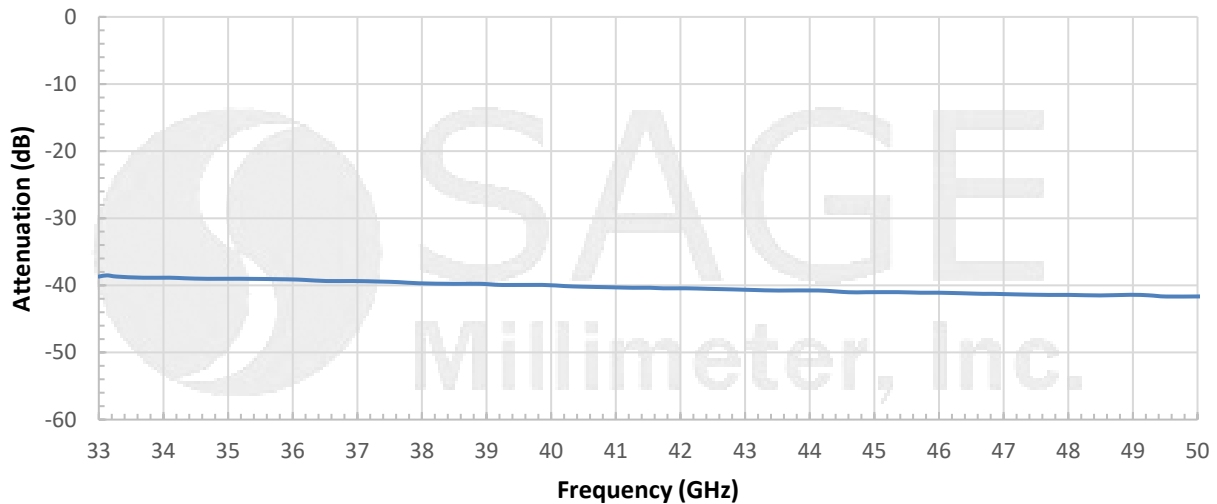

Mechanical Outline: (Unless otherwise specified, all dimensions are in inches [millimeters])

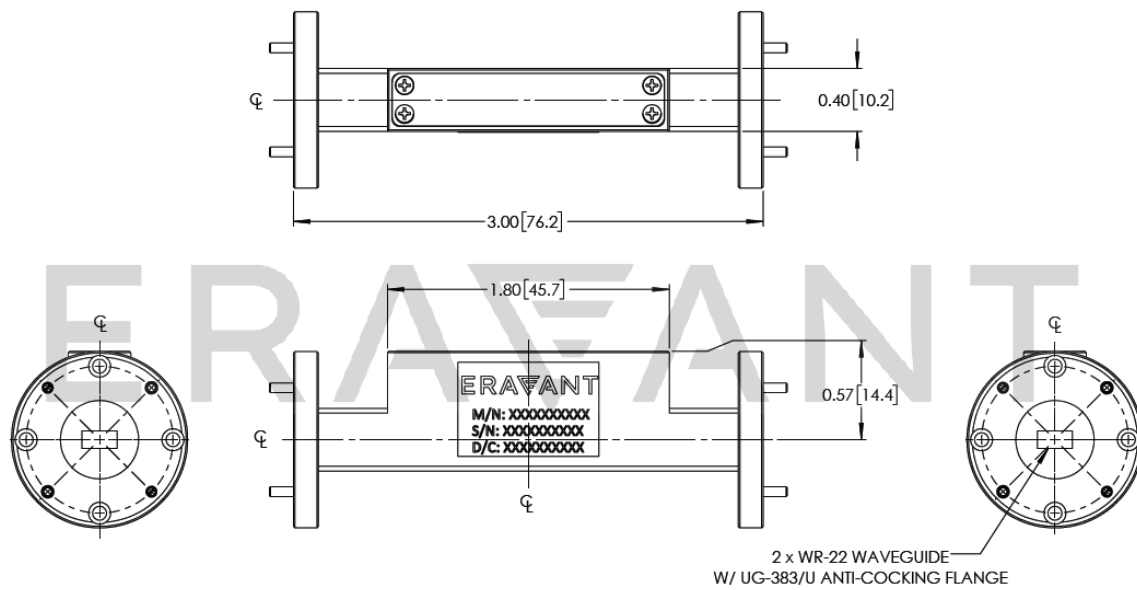

Note:

- All data presented is collected from a sample lot. Actual data may vary unit to unit, slightly.
- All testing was performed under +25 °C case temperature.
- SAGE Millimeter, Inc. reserves the right to change the information presented without notice.

Caution:

- Exceeding absolute maximum ratings will damage the device.
- Any foreign objects in the waveguide will cause performance issues and may damage the device.



www.sagemillimeter.com | 3043 Kashiwa Street, Torrance, CA 90505
 Phone: 424-757-0168 | Fax: 424-757-0188 | Email: sales@sagemillimeter.com