

STA-40-19-F1

U-Band Fixed Attenuator, 40 dB

STA-40-19-F1 is a 40 dB fixed attenuator that is used in millimeterwave systems and operates from 40 to 60 GHz. The attenuator has a fixed attenuation value of 40 dB at center frequency, 50 GHz. The attenuator's waveguides are manufactured with precision wire EDM to ensure high accuracy and a quality internal surface finish. The design features anti-cocking flanges to reduce misalignment errors and a sandblasted surface treatment to provide a durable finish. While the attenuator is designed for full waveguide band applications, the attenuation value does show a minor slope within the band due to its distinct mechanical configuration. Other attenuation values are available under different model numbers as **STA-XX-19-F1**, where **XX** is the desired attenuation value.



Electrical Specifications:

Parameter	Minimum	Typical	Maximum
Frequency Range	40 GHz		60 GHz
Attenuation @50GHz		40 dB	
Return Loss		20 dB	
Power Handling		500 mW	750 mW
Specification Temperature		+25°C	
Operating Temperature	-40°C		+85°C

Mechanical Specifications:

Item	Specification
Waveguide Ports	WR-19 Waveguide with UG-383/U-M Anti-Cocking Flange
Attenuation Setting	Fixed
Insertion Length	3.00"
Material	Brass
Finish	Gold Plated
Weight	4.5 Oz
Outline	TA-FU-A

ECCN

EAR99

FEATURES

- Full Band Coverage
- Low Cost
- Accurate Attenuation Value at Center Frequency

APPLICATIONS

- Test Lab
- Instrumentations
- System Integration

SUPPLEMENTAL DETAILS



STA-40-19-F1

Typical Performance vs. Frequency

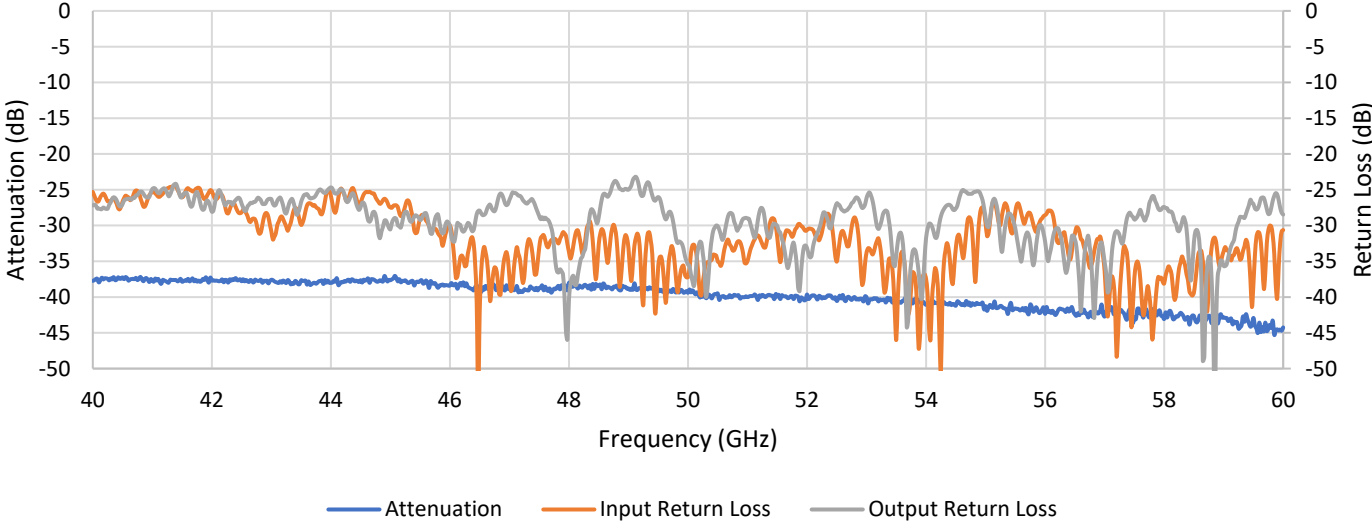

Mechanical Outline: (Unless otherwise specified, all dimensions are in inches [millimeters])

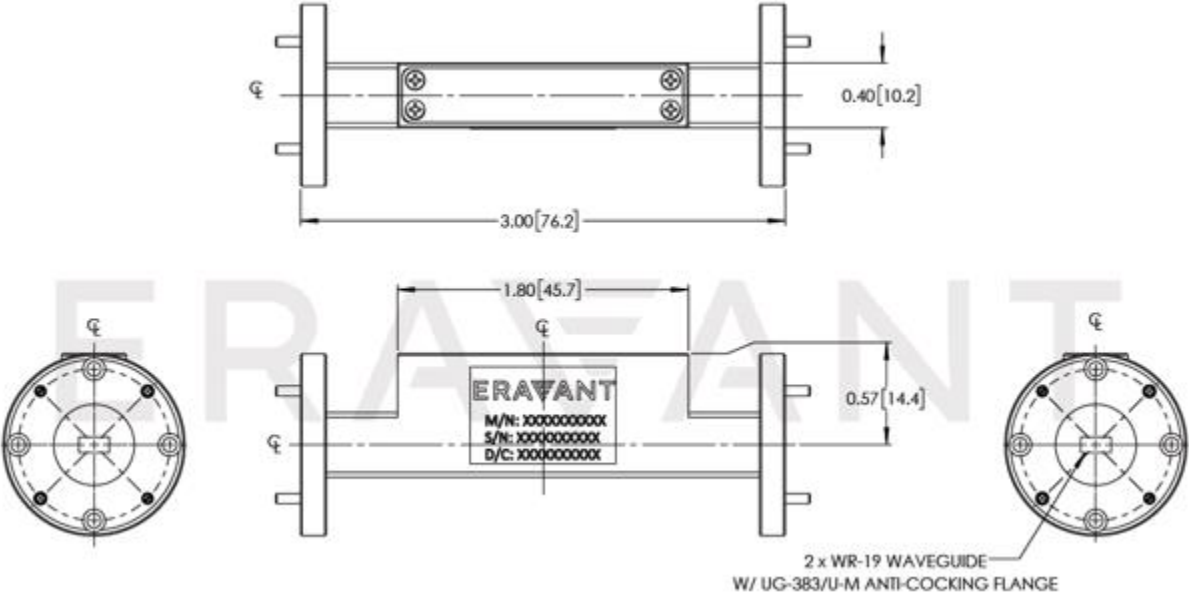

MAKING MILLIMETERWAVE ACCESSIBLE

NOTE:

- Test data provided is collected from a sample lot. Actual data may vary slightly from unit to unit. All testing is performed under +25 °C room temperature.
- Eravant reserves the right to change the information presented without notice.

CAUTION:

- Any foreign objects in the waveguide will cause performance degradation and may damage or destroy the unit.
- For 1 mm connectors proper torque should be applied: 4.0 ± 0.15 inch-pounds (0.45 ± 0.02 Nm). Torque wrench model SCH-06004-S1 is highly recommended.
- For 1.35 mm, 1.85 mm, 2.4 mm, 2.92 mm, and SMA connectors proper torque should be applied: 8.0 ± 0.15 inch-pounds (0.90 ± 0.02 Nm). Torque wrench model SCH-08008-S1 is highly recommended.

ERAVANT
MAKING MILLIMETERWAVE ACCESSIBLE

ERAVANT
MAKING MILLIMETERWAVE ACCESSIBLE