

## STA-20-08-F1

### F-Band Fixed Attenuator, 20 dB

**STA-20-08-F1** is a 20 dB fixed attenuator that is used in millimeterwave systems and operates from 90 to 140 GHz. The attenuator has a fixed attenuation value of 20 dB at center frequency, 115 GHz. The attenuator's waveguides are manufactured with precision wire EDM to ensure high accuracy and a quality internal surface finish. The design features anti-cocking flanges to reduce misalignment errors and a sandblasted surface treatment to provide a durable finish. While the attenuator is designed for full waveguide band applications, the attenuation value does show a minor slope within the band due to its distinct mechanical configuration. Other attenuation values are available under different model numbers as **STA-XX-08-F1**, where **XX** is the desired attenuation value.



#### Electrical Specifications:

Parameter	Minimum	Typical	Maximum
Frequency Range	90 GHz		140 GHz
Attenuation Range @ 115 GHz		20 dB	
Return Loss		20 dB	
Power Handling			300 mW (CW)
Specification Temperature		+25°C	
Operating Temperature	-40°C		+85°C

#### Mechanical Specifications:

Item	Specification
Waveguide Ports	WR-08 Waveguide with UG-387/U-M Anti-Cocking Flange
Attenuation Setting	Fixed
Insertion Length	2.00"
Material	Brass
Finish	Gold Plated
Weight	1.5 Oz
Outline	TA-FF-A

#### ECCN

EAR99

#### FEATURES

- Full Band Coverage
- Low Cost
- Accurate Attenuation Value at Center Frequency

#### APPLICATIONS

- Test Lab
- Instrumentations
- System Integration

#### SUPPLEMENTAL DETAILS



### Typical Performance vs Frequency

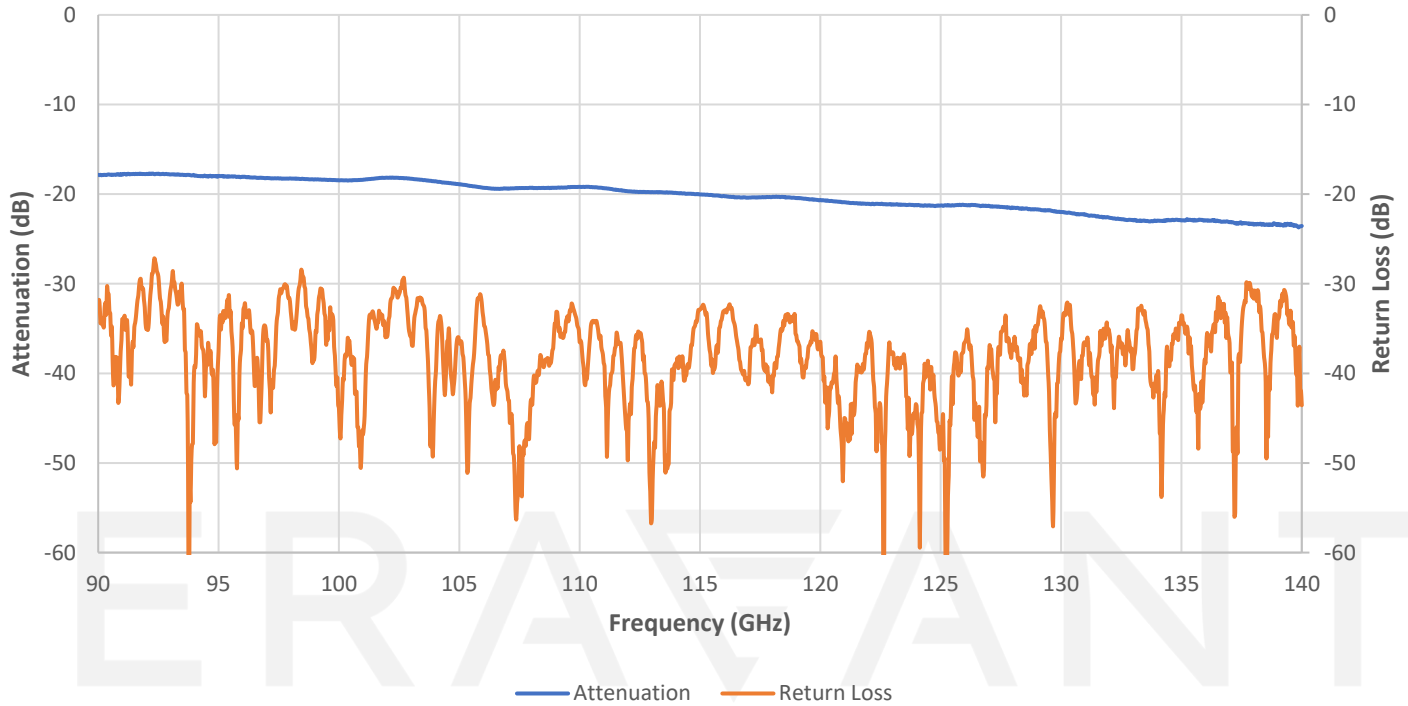

### Mechanical Outline: (Unless otherwise specified, all dimensions are in inches [millimeters])

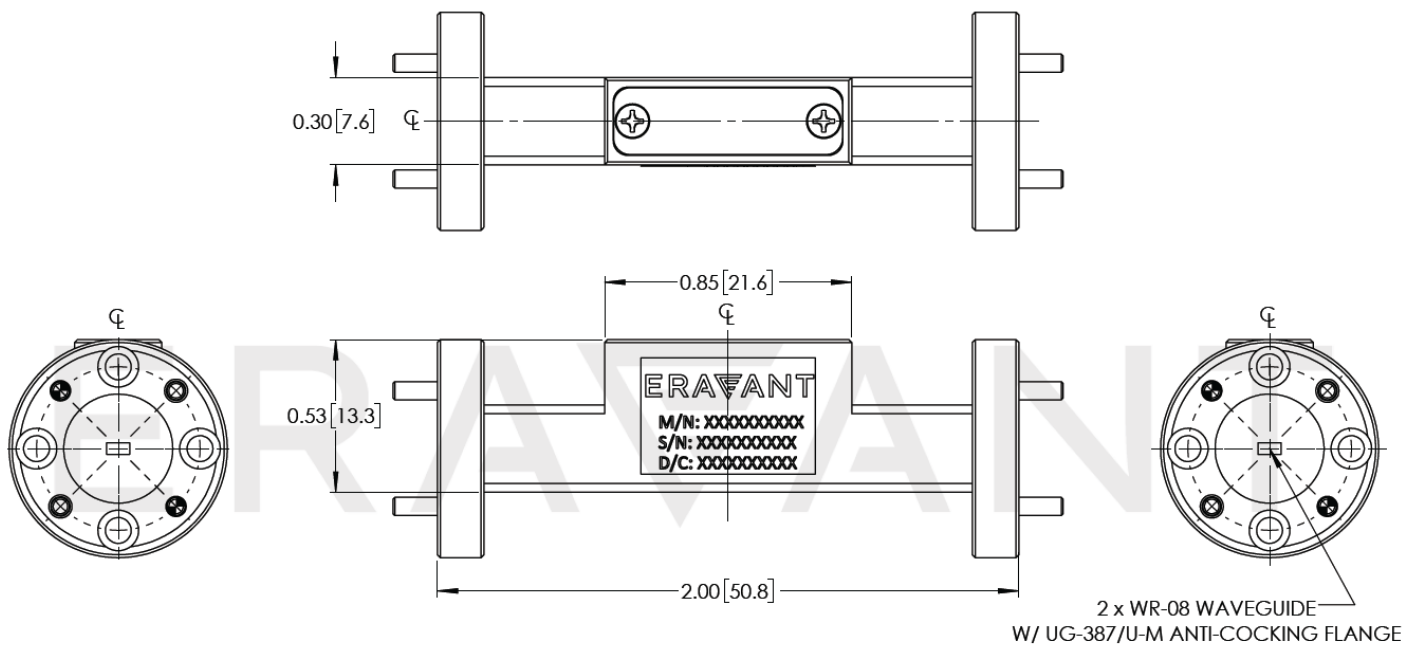

**NOTE:**

- All data presented is collected from a sample lot. Actual data may vary unit to unit, slightly.
- All testing was performed under +25 °C case temperature.
- Eravant reserves the right to change the information presented without notice.

**CAUTION:**

- Exceeding absolute maximum ratings will damage the device.
- Any foreign objects in the waveguide will cause performance degradation and may damage the device.

ERAVANT  
MAKING MILLIMETERWAVE ACCESSIBLE

ERAVANT  
MAKING MILLIMETERWAVE ACCESSIBLE