

SAY-9231144511-10-S1

W-Band Cassegrain Antenna, 92 to 114 GHz, 9", 45 dBi Gain

SAY-9231144511-10-S1 is a W-band Cassegrain antenna that offers a nominal gain of 45 dBi and a typical half power beamwidth of 1.1 degrees from 92 to 114 GHz. The aluminum reflector offers a lightweight and rugged mechanical structure and is treated with a clear chem film conversion coating for corrosion resistance. A corrugated scalar feed horn is used to provide optimal feed efficiency, low side lobes, high cross-pol rejection, and uniform illumination. The antenna port is a WR-10 waveguide with UG-387/U-M anti-cocking flange and can support linear polarized waveforms. Other port configurations, such as circular waveguide port, are available under different model numbers.



Electrical Specifications:

Parameter	Minimum	Typical	Maximum
Frequency	92 GHz		114 GHz
Gain		45 dBi	
3 dB Beamwidth		1.1°	
Sidelobes		-17 dB	
Return Loss		15 dB	
Specification Temperature		+25 °C	
Operating Temperature	-40 °C		+85 °C

Mechanical Specifications:

Item	Specification
Antenna Port	WR-10 Waveguide with UG 387/U-M Anti-Cocking Flange
Reflector Diameter	9"
Reflector Material	Aluminum
Finish	Clear Chem Film
Outline	AY-RW45-09-A

ECCN

EAR99

FEATURES

- Linear Polarization
- Low Side Lobe Levels
- High Cross-Polarization

APPLICATIONS

- Radar Communication System
- EW Systems

SUPPLEMENTAL DETAILS

SAY-9231144511-10-S1

Mechanical Outline: (Unless otherwise specified, all dimensions are in inches [millimeters])

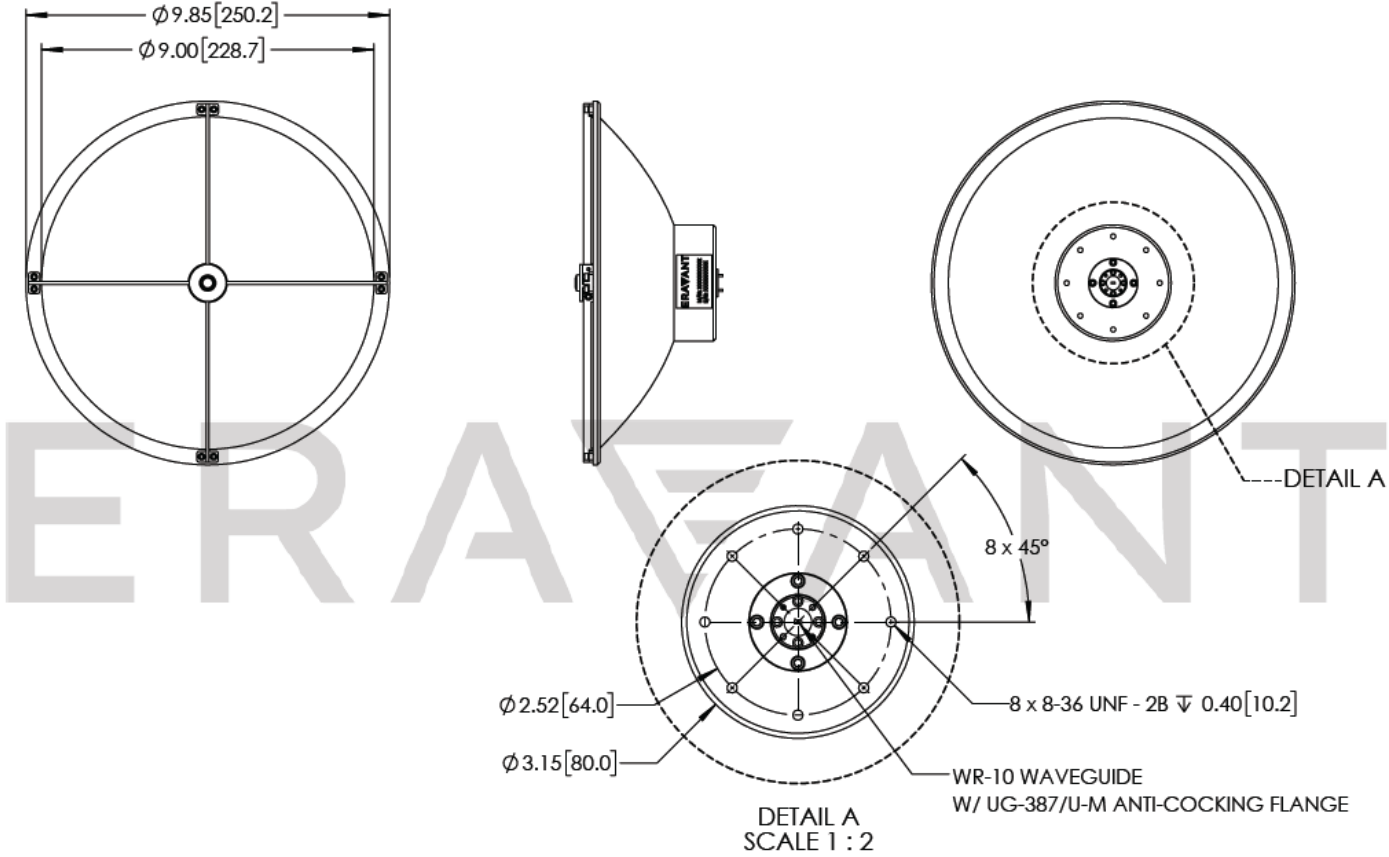

NOTE:

- Test data provided is collected from a sample lot. Actual data may vary slightly from unit to unit. All testing is performed under +25 °C room temperature.
- For the simulated test data provided, actual measured data may slightly vary.
- Eravant reserves the right to change the information presented without notice.

CAUTION:

- Any foreign objects in the antenna will cause performance degradation and possible device damage.

ERAVANT
MAKING MILLIMETERWAVE ACCESSIBLE