

1 MHz – 6 GHz RF Mixer with built in PLL Synthesizer

Features

- Open source Labview GUI software control via USB
- Run hardware functions with or without a PC
- Use as an RF Mixer or as an RF Signal Generator
- Upconvert or Downconvert
- 1Hz frequency resolution PLL
- Mixer input frequencies from 1MHz – 6GHz
- Mixer output frequencies from 5MHz – 4.5GHz
- LO output frequencies from 85MHz – 5GHz
- 3mS LO RF lock time standard
- Up to +7dBm signal generator output power
- 10MHz – 100MHz external reference input
- 2.5ppm internal 10MHz reference
- Internal and external Frequency Shift Modulation
- 2.5" X 1.375" X 0.75" (6.35cm X 3.5cm X 1.9cm)

Overview Description

The Windfreak MixNV is a 1MHz to 6GHz software programmable RF mixer which can up-convert, down-convert, or act as an RF Signal Generator. It has a built-in

Phase Locked Local Oscillator controlled and powered by a PC running Windows, Android or Linux via its USB port. (Android and Linux require free 3rd party command line terminal software).

The oscillator will tune from 85MHz to 4.2GHz in 1Hz steps using an advanced sigma-delta modulator PLL that delivers low fractional spurious products and excellent phase noise. (Tunes to 5GHz with reduced performance.)

The MixNV also has nonvolatile on board memory so it can be programmed to fire up by itself to any LO frequency, FSK modulation, or other settings. This allows the end user to put it in a box or rack without the need for PC control.

Applications

- Wireless communications systems
- RF and Microwave radios
- Software Defined Radio (SDR)
- \$20 RTL-SDR 6GHz Frequency Extender
- Superheterodyne Receiver
- Frequency Up Conversion
- Frequency Down Conversion
- Frequency Shift Key Modulator
- Automated Test Equipment (ATE)
- Radar
- Quantum device research

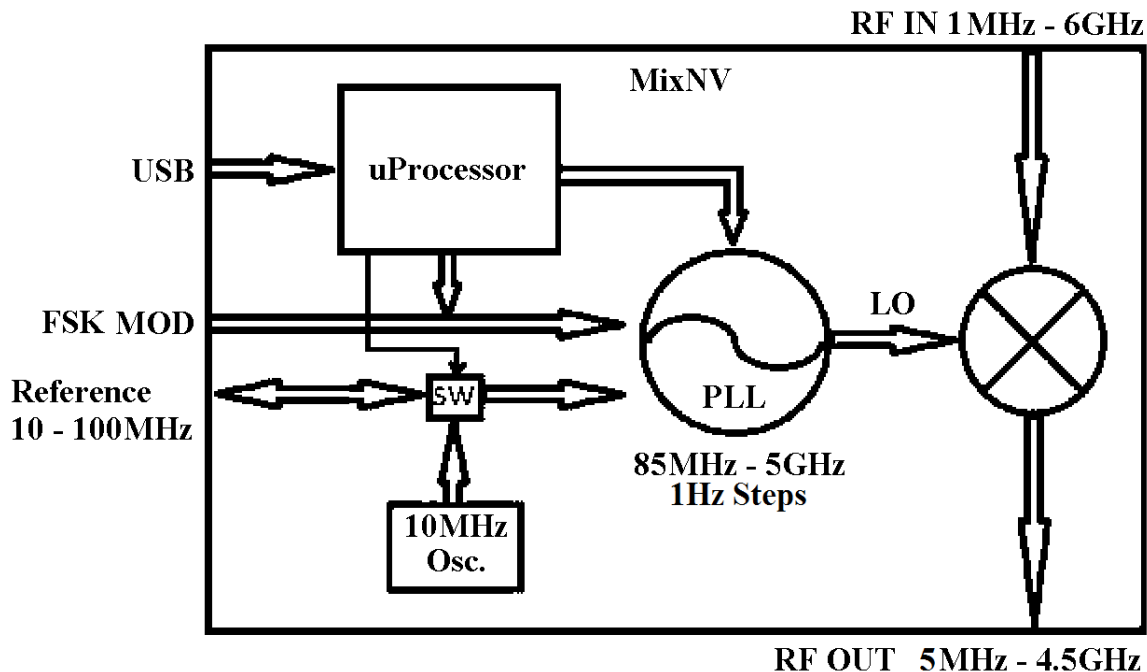

Contents

1	Characteristics	3
1.1	Electrical Characteristics	3
1.2	Thermal Operating Characteristics	4
2	Typical Performance	5
2.1	LO Mode RF Output Power	5
2.2	LO Mode RF Output Harmonic Content.....	6
2.3	Mixer Mode Conversion Gain.....	7
2.4	LO Feedthrough	9
2.5	LO Phase Noise	10
2.6	Mixer Mode Intermodulation Distortion.....	11
3	Device Information	12
3.1	Mechanical Dimensions	12
3.2	Typical Product Photos.....	13

1 Characteristics

1.1 Electrical Characteristics

Characteristic	Notes	Min.	Typ.	Max.	Unit
Supply Voltage	From Power Plug	4.0	5.0	6.0	V
Supply Voltage *1	From USB Connector	4.5	5.0	6.0	V
Supply Current			120	200	mA
Mixer Input Frequency Range		1	-	6000	MHz
Mixer Output Frequency Range		5		4500	MHz
LO Frequency Range	Over full temperature range	85		4200	MHz
LO Frequency Range	At room temperature	85		5000	MHz
LO RF Output Power	See Section 2.1 Graphs			7	dBm
Down Conversion Gain	Output at 5MHz – 500MHz		-7		dB
Up Conversion Gain	See Section 2.3 Graphs		-10	-7	dB
RF Input / Output Impedance			50		Ω
RF Input Maximum Power				12	dBm
RF Input P1dB	Mixer Mode Linearity = 7		10		dBm
Phase Noise (LO = 1GHz) 10KHz Offset	100MHz Ext Reference		-108		dBc/Hz
	10MHz Int Reference		-98		
Phase Noise (LO = 2GHz) 10KHz Offset	100MHz Ext Reference		-102		dBc/Hz
	10MHz Int Reference		-92		
Phase Noise (LO = 3GHz) 10KHz Offset	100MHz Ext Reference		-98		dBc/Hz
	10MHz Int Reference		-88		
Phase Noise (LO = 4GHz) 10KHz Offset	100MHz Ext Reference		-96		dBc/Hz
	10MHz Int Reference		-86		
Mixer Noise Figure	Mixer Mode Linearity = 7		15		dB
	Mixer Mode Linearity = 2		11		
IIP3 (See Section 2.6)	Mixer Mode Linearity = 5		23		dBm
	Mixer Mode Linearity = 1		10		
Internal Reference Frequency			10		MHz

Internal Reference Tolerance			2.5		ppm
External Reference Frequency		10	-	100	MHz
External Reference Level In	CMOS or Clipped Sine		1	2	Vpp
Internal Reference Level Out	Square CMOS 10MHz		17		dBm

Notes: *1 Keep power plug voltage at or above Vusb to draw current from the power plug, rather than Vusb. A diode protects Vusb from reverse current back into the computers USB port.

1.2 Thermal Operating Characteristics

Description	Notes	Min	Max	Unit
Operating Temperature	By design	-40	85	°C

2 Typical Performance

2.1 LO Mode RF Output Power

The typical LO Mode output power of the MixNV is shown below. The MixNV has two modes, Mixer Mode and LO Mode. LO Mode biases the mixer and allows maximum LO feedthrough so the device can be used as a basic RF Signal Generator. The MixNV has a 3-bit power setting in LO Mode, settable from 0 (minimum power) to 7 (maximum power).

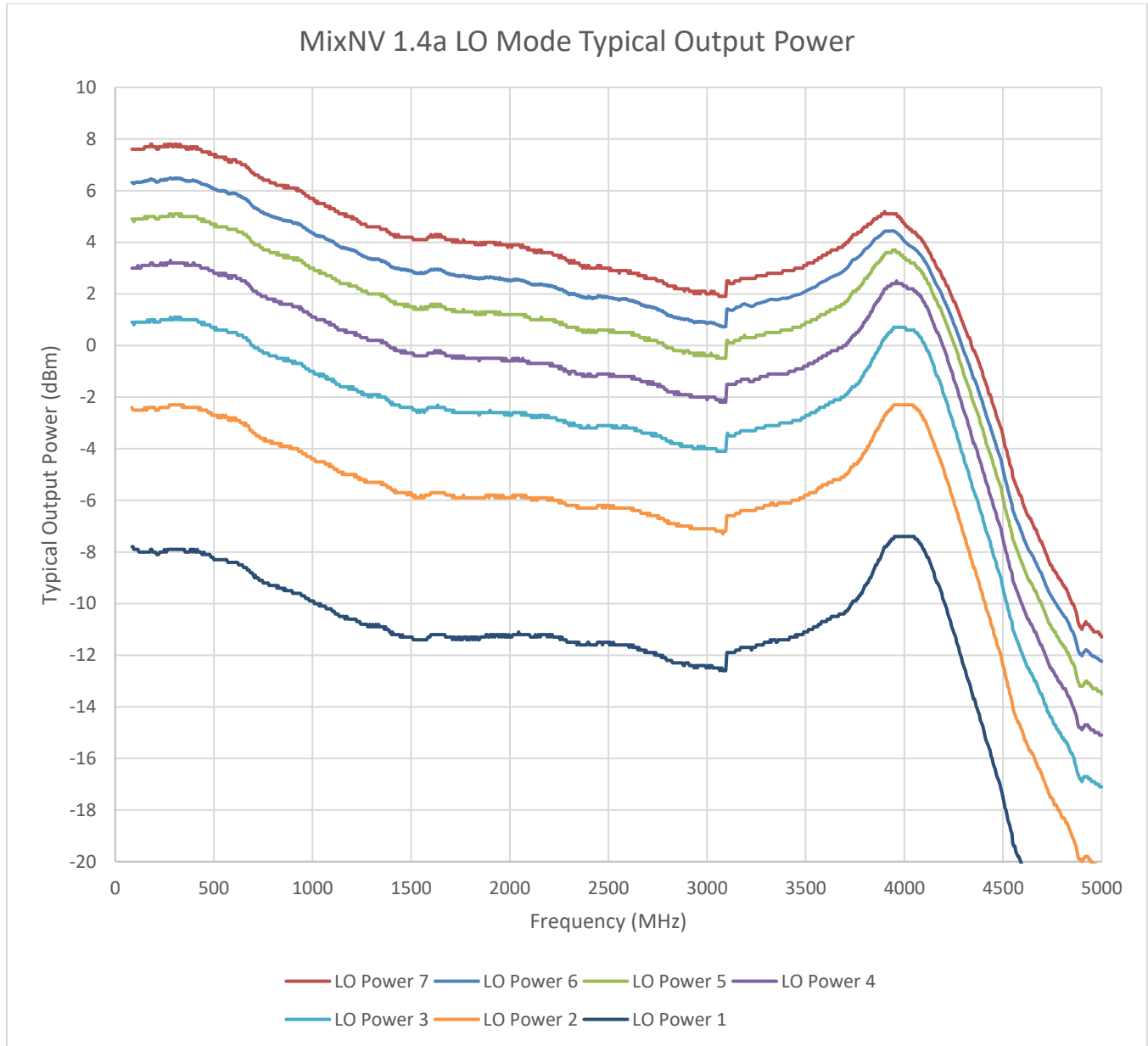

The minimum power setting of 0 is LO feed through and very low power as shown in the next graph.

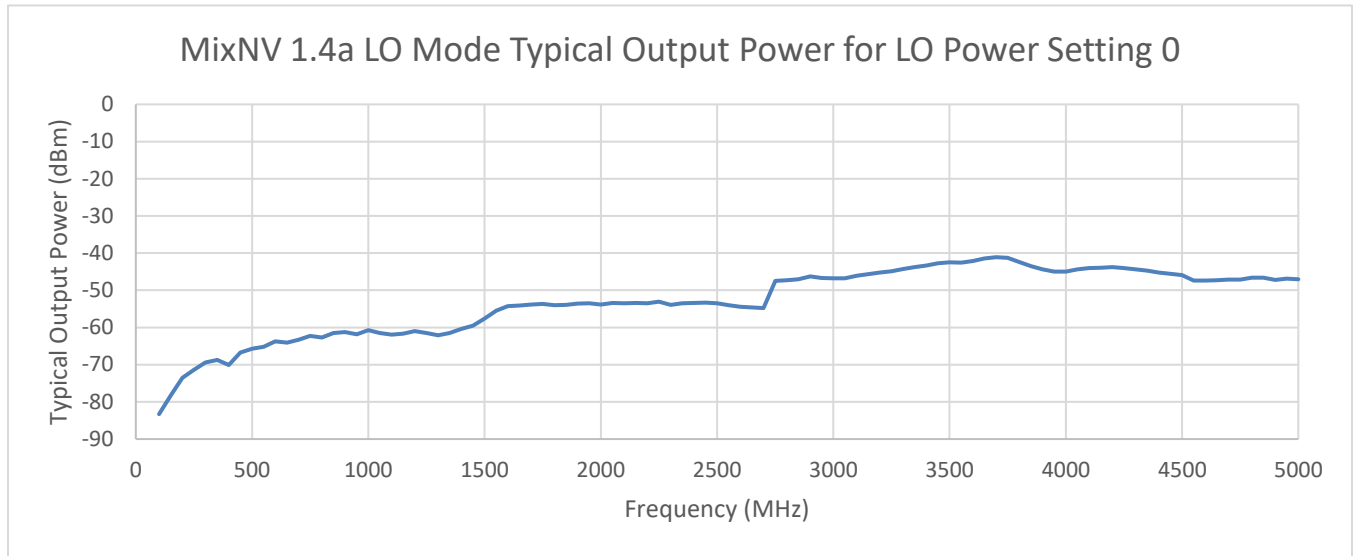

2.2 LO Mode RF Output Harmonic Content

The typical MixNV LO Mode harmonic distortion is shown below for the second and third harmonics. This data is taken at the maximum LO power setting of 7 and shown in dBc.

If lower harmonic levels are needed, Windfreak Technologies suggest the use of low cost SMA filters from Crystek. A \$25 1GHz example would be the CLPFL-1000. There are usually many different frequency cut-offs in stock at Digikey.

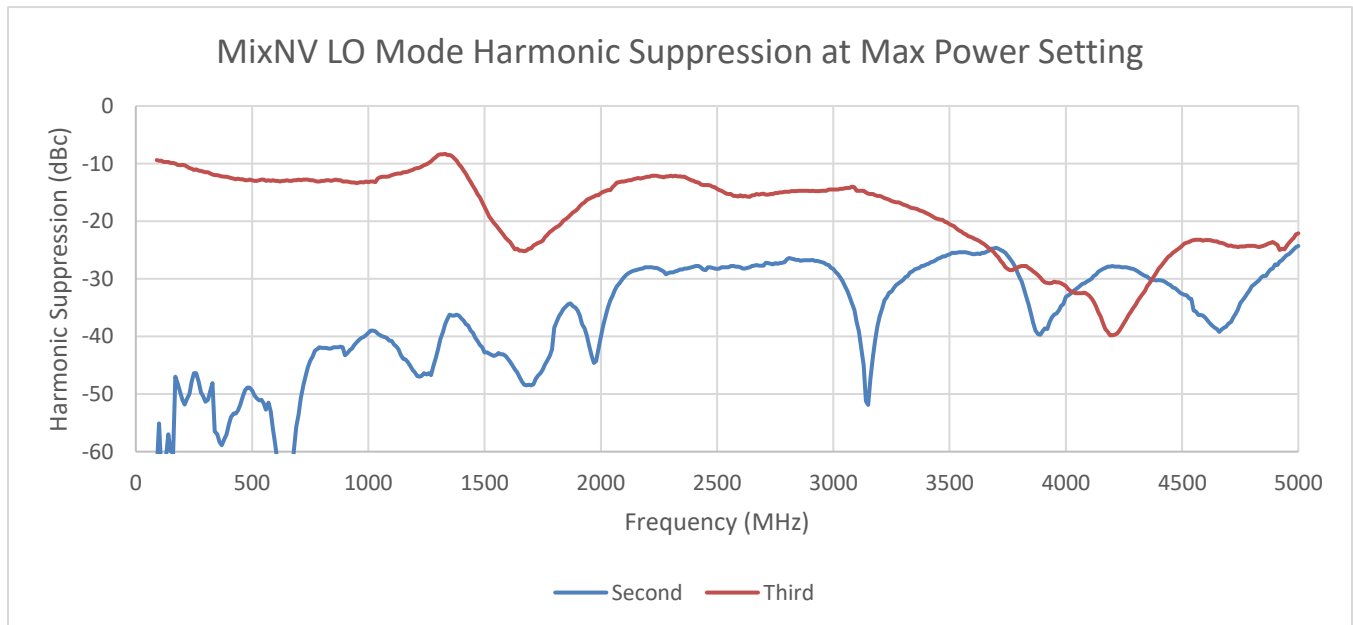

2.3 Mixer Mode Conversion Gain

The MixNV has a dedicated input and output. It is not bi-directional. The Gilbert Cell mixer itself is passive and thus has negative gain. To use this device as an upconverter or downconverter it should be treated as a normal mixer with consideration to LO feedthrough, Upper Side Band and Lower Side Band images with associated spectral inversions, input RF feedthrough and all associated harmonics and their products.

All plots in this section are made with a Mixer Linearity Setting of 3.

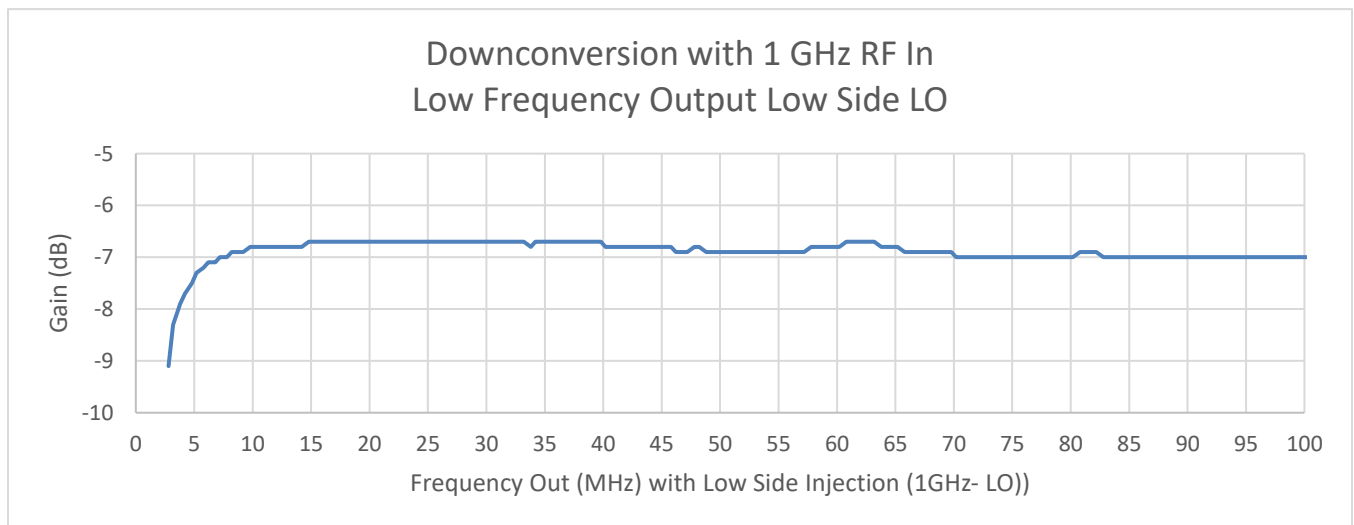
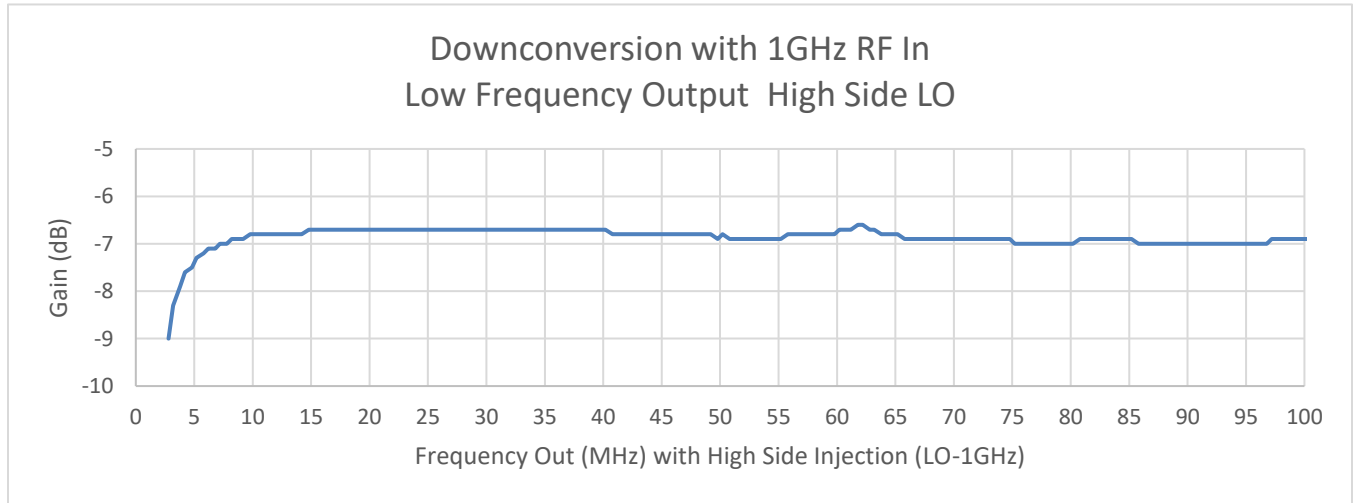

Downconversion Gain with various RF Input Frequencies using Low Side LO Injection ($R_{Fout} = R_{Fin} - LO$)

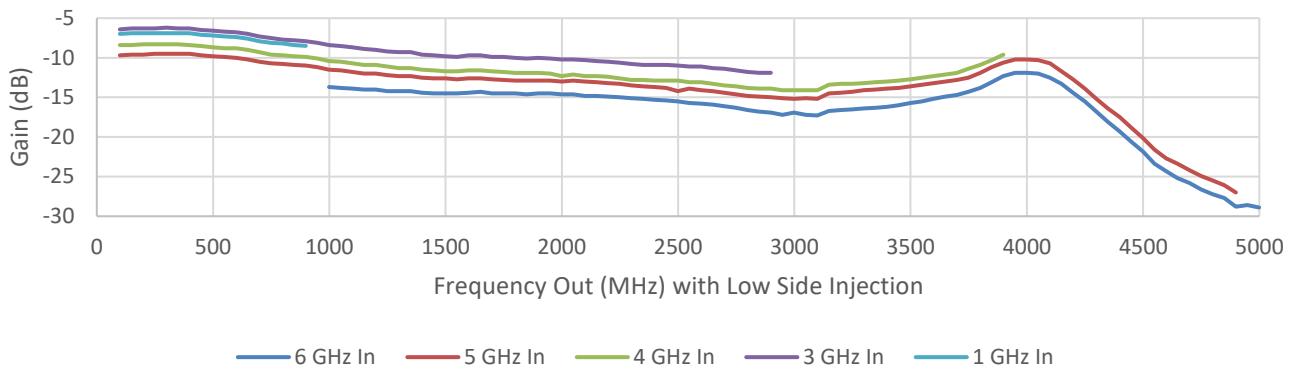

Downconversion Gain to 100MHz RF out

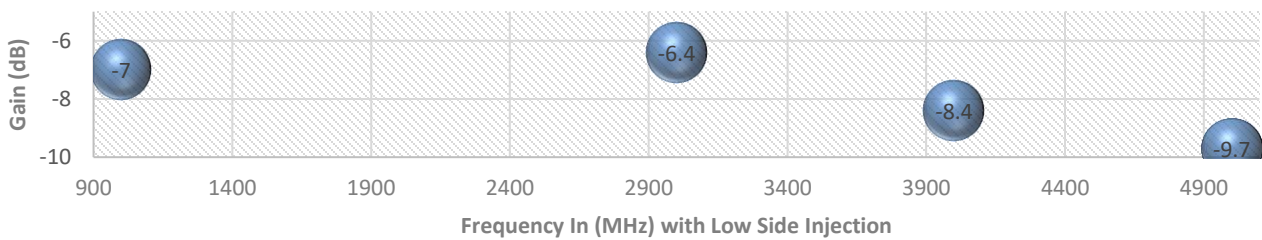

Upconversion Gain with Input Signals 1MHz, 60MHz, 150MHz

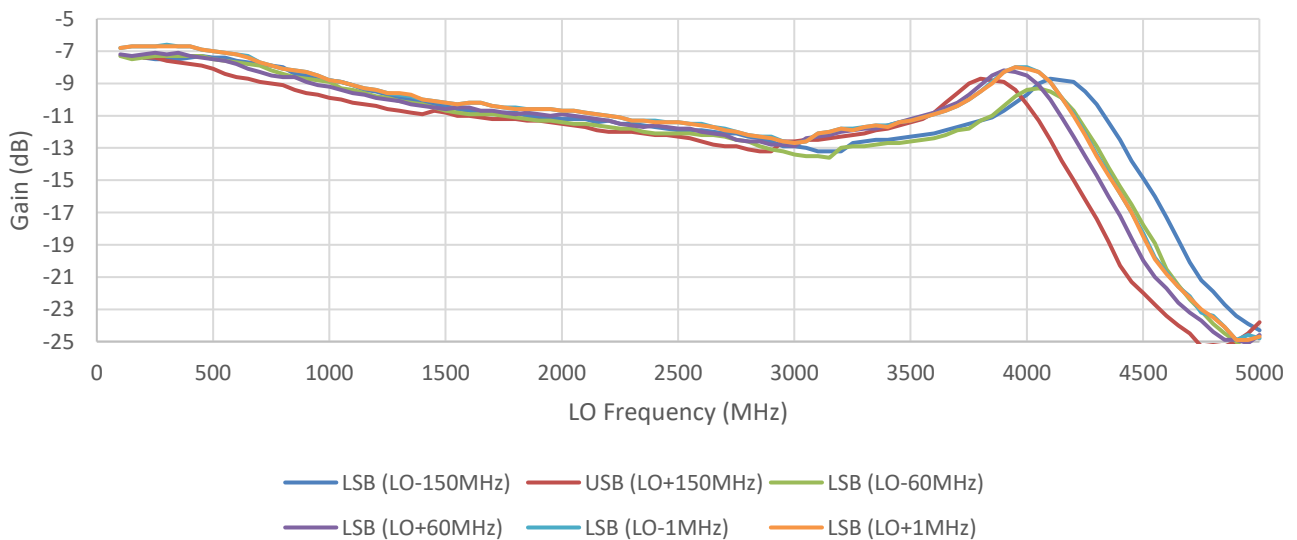

2.4 LO Feedthrough

LO feedthrough in Mixer Mode with 50 ohm terminated input and no input signal.

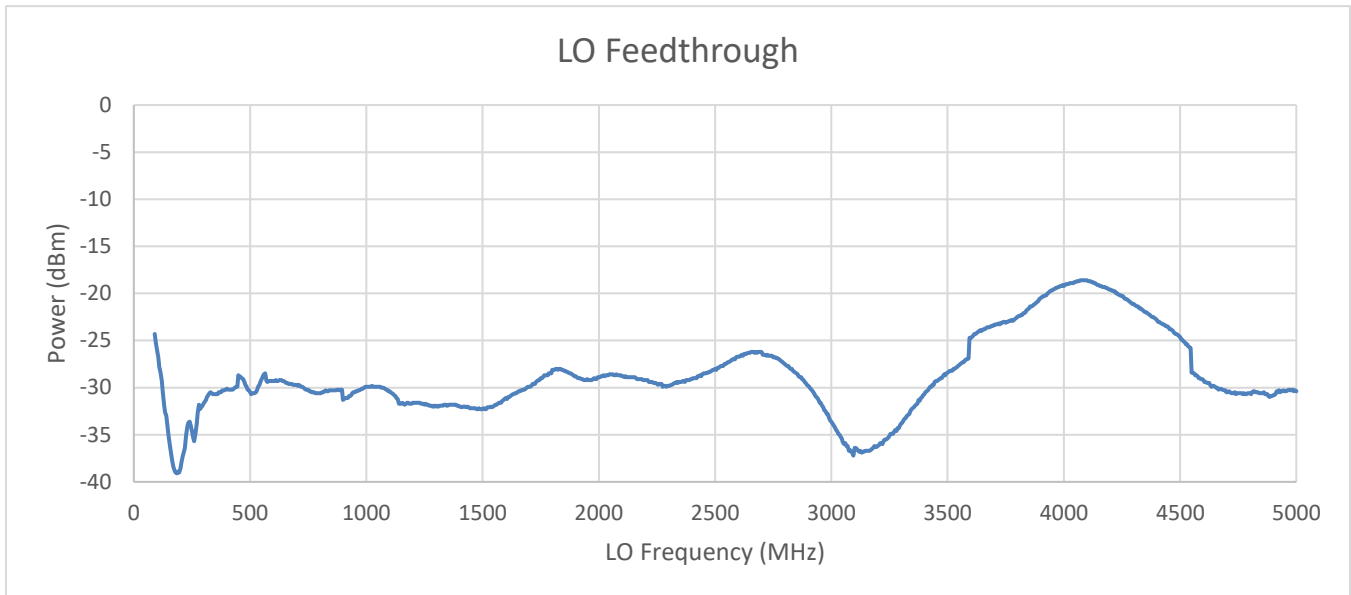

2.5 LO Phase Noise

Phase noise in LO Mode and Mixer Mode will be similar. Phase noise on the local oscillator is better at low RF carrier frequencies and gets worse at higher frequencies. See plot for typical phase noise at 2.6GHz with two different reference options. Phase noise (and frequency accuracy in general) can be made better with an external reference. Higher reference frequencies yield higher phase comparison frequencies and thus better phase noise. The MixNV highest phase comparison frequency is 50 MHz, so it automatically divides the reference frequency by 2 when the reference frequency is over 50MHz.

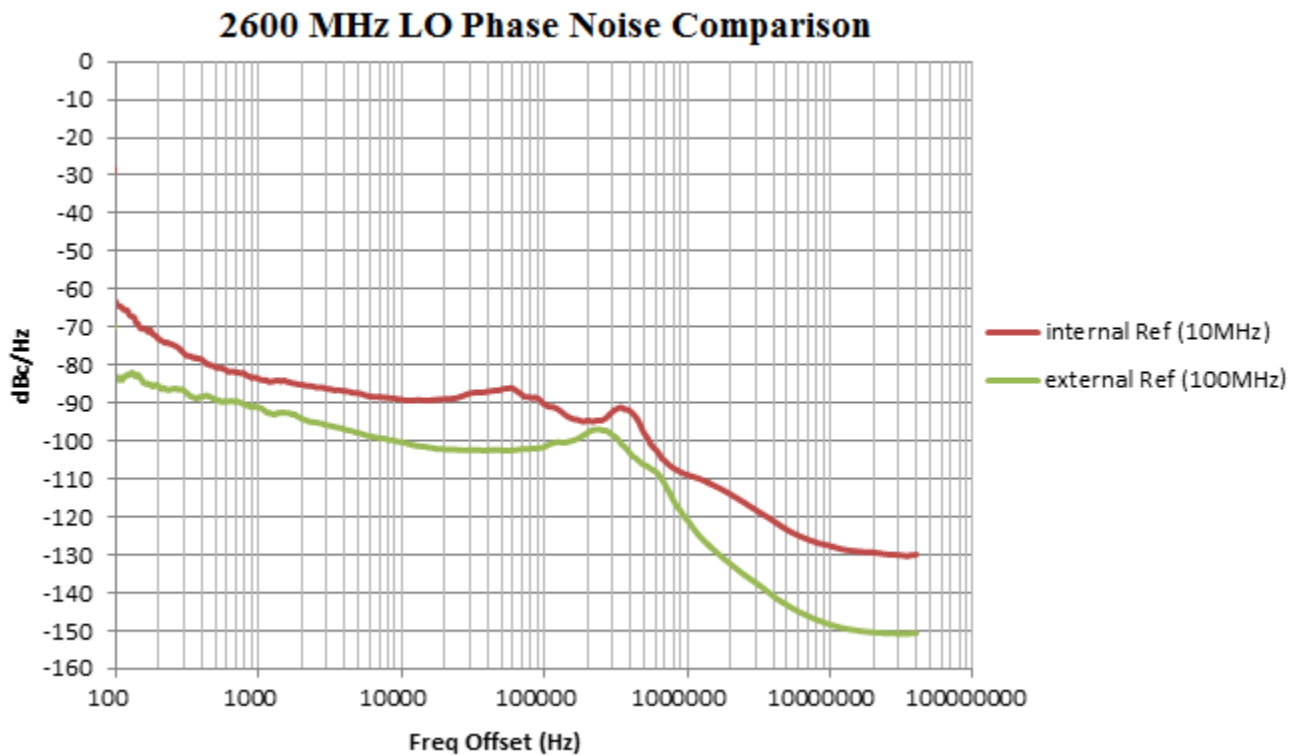

2.6 Mixer Mode Intermodulation Distortion

In the Down Conversion example below the MixNV is fed two tones on either side of 1GHz at -10dBm with a 1MHz separation in each tone. The LO is set to 900 MHz low side injection giving a 100MHz IF output with 7dB of loss in the fundamental signal giving -17dBm of fundamental power in each output tone. IMD is measured at roughly -83dBm. This gives an OIP3 of +16dBm. Factoring in the gain of the mixer stage gives +23dBm of IIP3.

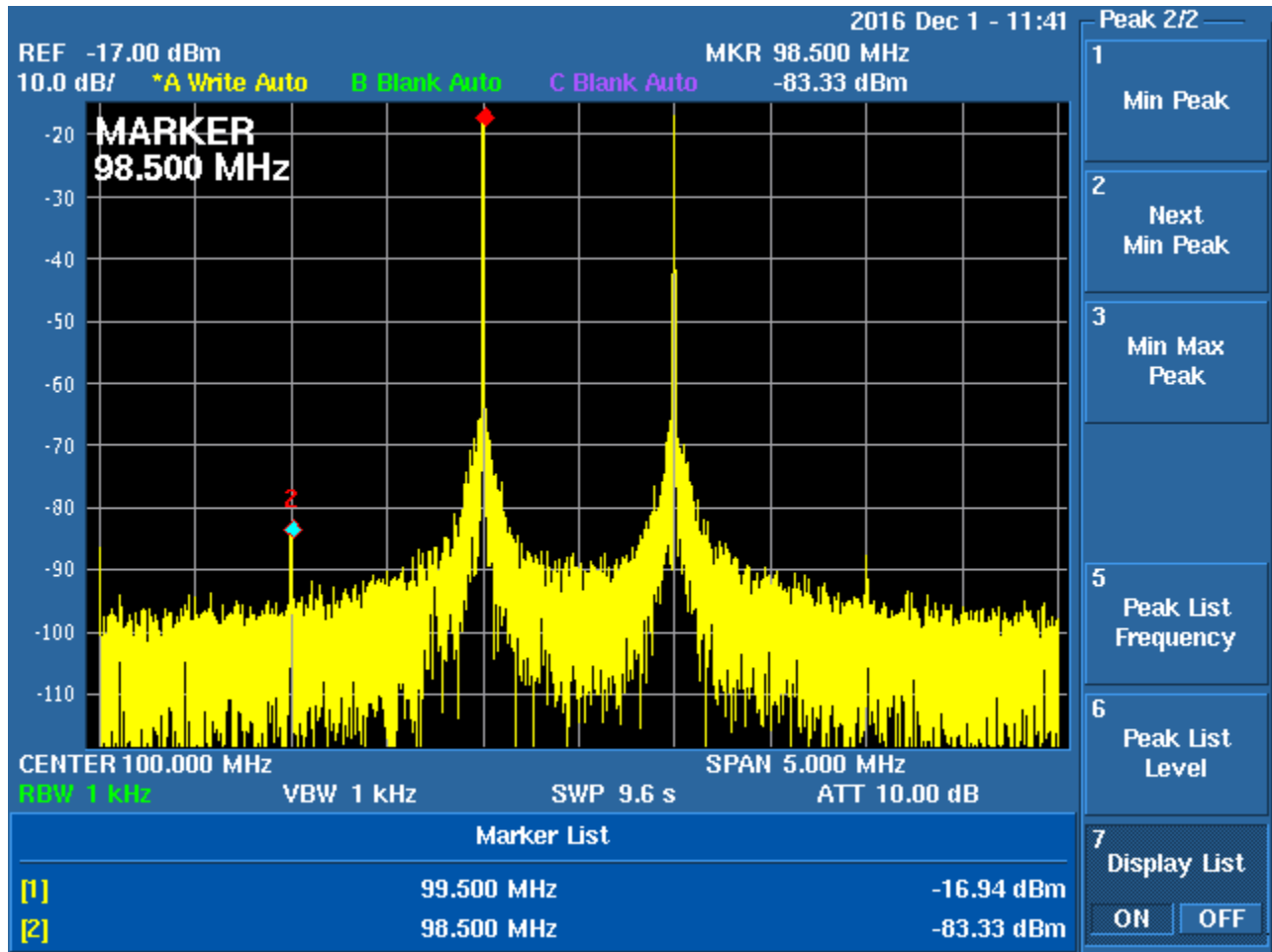

3 Device Information

3.1 Mechanical Dimensions

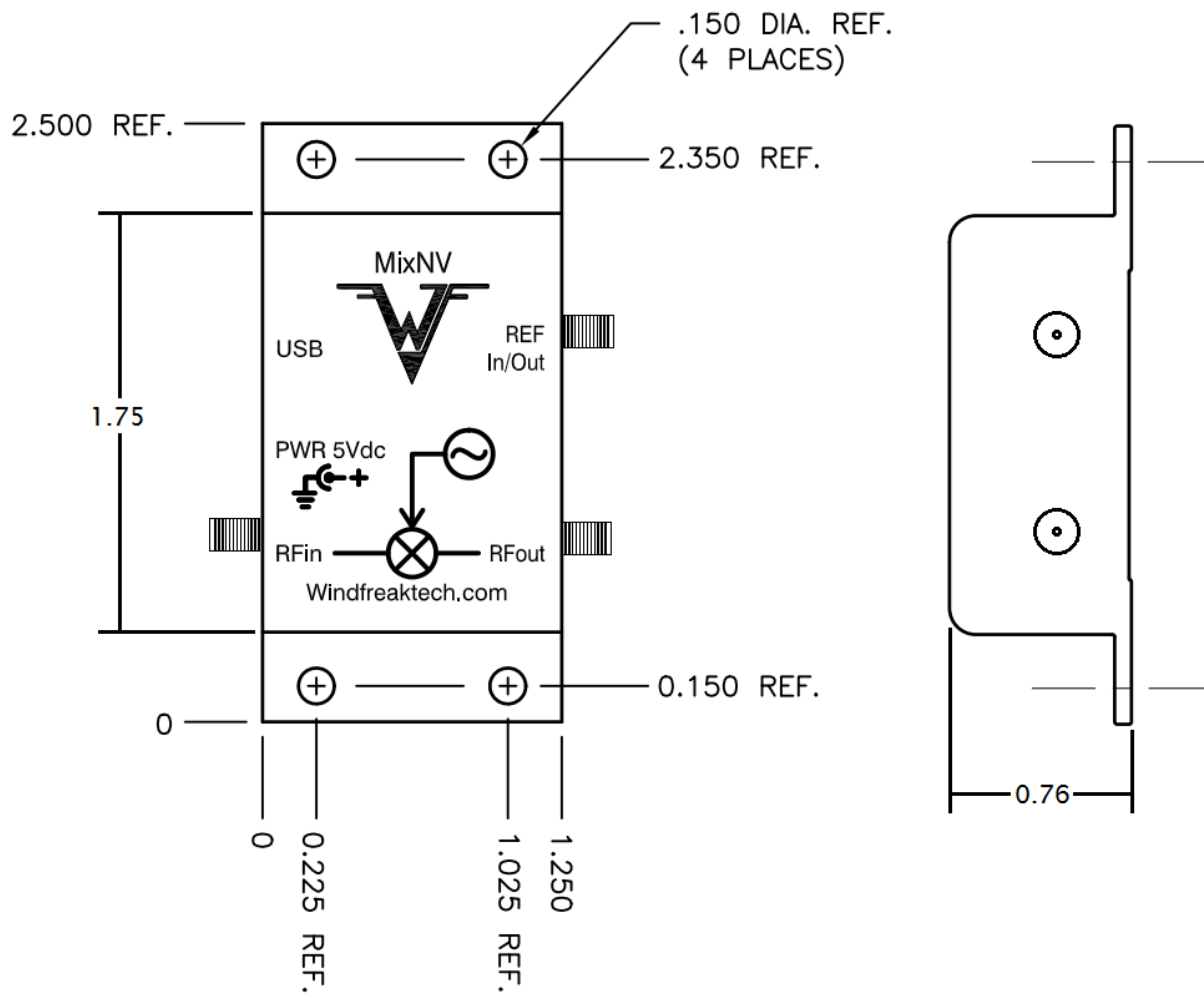

Figure 1. Outer Dimensions in Inches

Weight is 2.4oz or 69 grams

3.2 Typical Product Photos



Reference and RFout



USB, Power and RFin

