



## Coaxial Lowpass Filter, DC to 25 GHz

### Description:

**Model SCF-25340330-KFKM-L1** is a coaxial lowpass filter with a pass band from DC to 25 GHz. The typical insertion loss of the pass band is 0.6 dB. The rejection band is from 40 to 60 GHz with a typical rejection value of 30 dB. The RF connectors of the filter are K(F) and K(M) connectors. The passband typical return loss is 15 dB. Other configurations, such as different connectors for input and output are available under different model numbers.



### Features:

- Broad Passband
- Low Insertion Loss
- Compact Design

### Applications:

- Test Labs
- Instrumentations
- Sub-assemblies

### Electrical Specifications:

Parameter	Minimum	Typical	Maximum
Passband Frequency	DC		25 GHz
Passband Insertion Loss		0.6 dB	
Rejection Frequency	40 GHz		60 GHz
Rejection Value		30 dB	
Passband Return Loss		15 dB	
Impedance		50 Ω	
Power Handling			1 W (CW)
Specification Temperature		+25 °C	
Operating Temperature	-40 °C		+75 °C

### Mechanical Specifications:

Item	Specifications
RF Ports	K(F) and K(M)
Case Material	Aluminum
Weight	0.5 Oz
Finishing	Gold Plated
Size	0.85" (L) x 0.50" (W) x 0.50" (H)
Outline	CF-LAU



## Coaxial Lowpass Filter, DC to 25 GHz

Typical Insertion and Return Loss vs Frequency

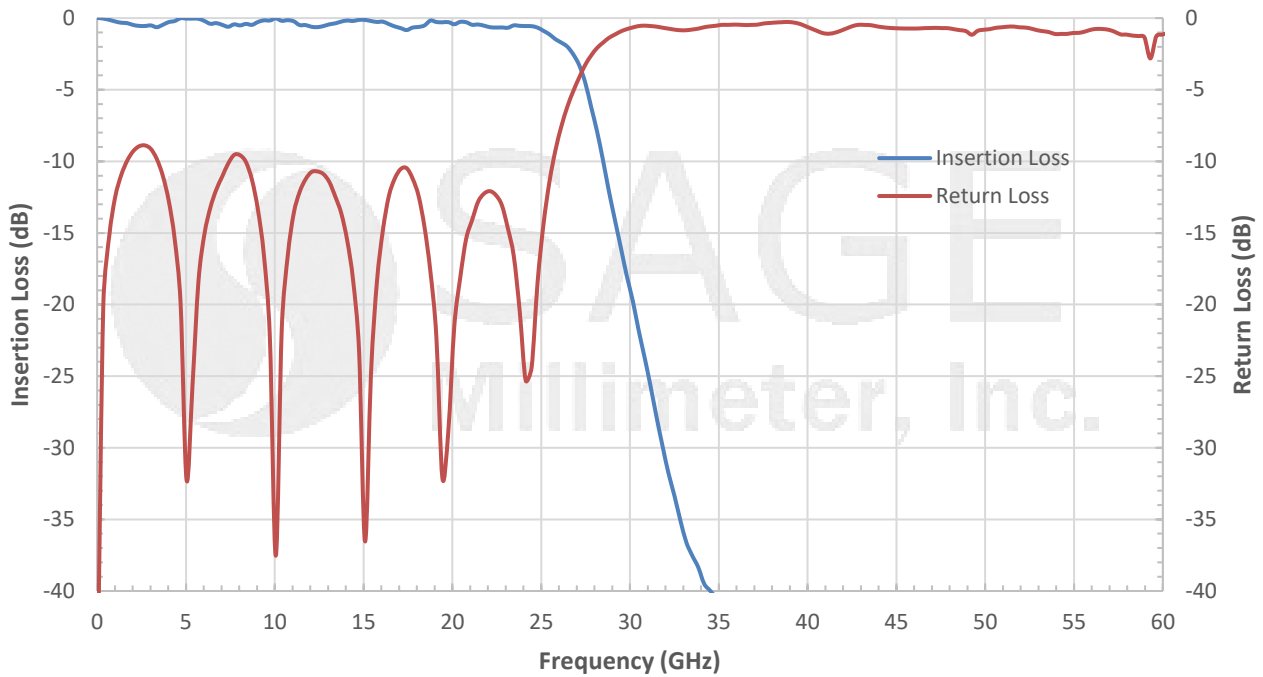

**Mechanical Outline:** (Unless otherwise specified, all dimensions are in inches [millimeters])

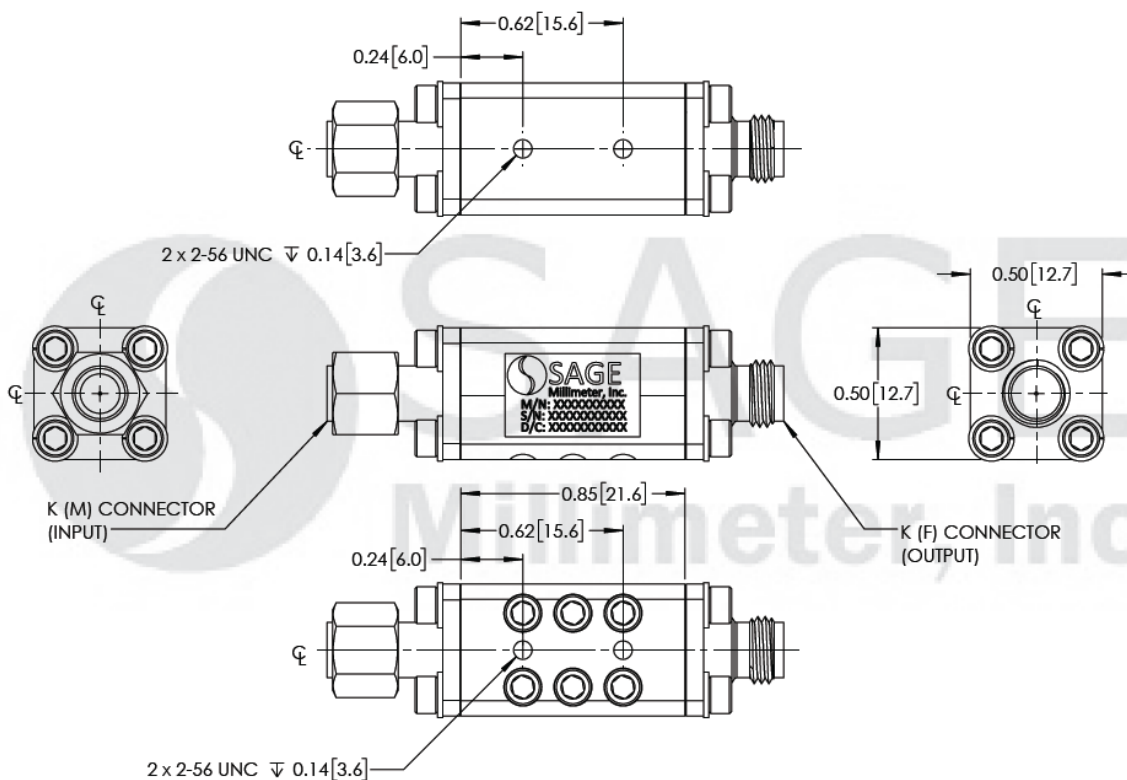

www.sagemillimeter.com | 3043 Kashiwa Street, Torrance, CA 90505  
 Phone: 424-757-0168 | Fax: 424-757-0188 | Email: sales@sagemillimeter.com

## Coaxial Lowpass Filter, DC to 25 GHz

### Note:

- All data presented is collected from a sample lot. Actual data may vary unit to unit, slightly.
- All testing was performed under +25 °C case temperature.
- SAGE Millimeter, Inc. reserves the right to change the information presented without notice.

### Caution:

- Proper torque,  $8.0 \pm 0.15$  inch-pounds ( $0.90 \pm 0.02$  Nm), should be applied. **SAGE Millimeter torque wrench, model SCH-08008-S1, is highly recommended.**

