

# Passive GaAs MMIC IQ Mixer

# MMIQ-1040S

## 1. Device Overview

### 1.1 General Description

MMIQ-1040S is a high linearity, passive GaAs MMIC IQ mixer. This is an ultra-broadband mixer spanning 10 to 40 GHz on the RF and LO ports with an IF from DC to 12 GHz. Up to 30 dBc of image rejection is available due to the excellent phase and amplitude balance of its on-chip LO quadrature hybrid. Both wire bondable die and connectorized modules are available.



Die



Module

### 1.2 Electrical Summary

Parameter	Typical	Unit
RF/LO Frequency Range	10 - 40	GHz
IF Frequency Range	DC - 12	GHz
I+Q Conversion Loss	9	dB
Image Rejection	25	dBc
LO-RF Isolation	44	dB

### 1.3 Applications

- Single Side Band & Image Rejection Mixing
- IQ Modulation/Demodulation
- Vector Amplitude Modulation
- Band Shifting
- 5G Band Support

### 1.4 Functional Block Diagram

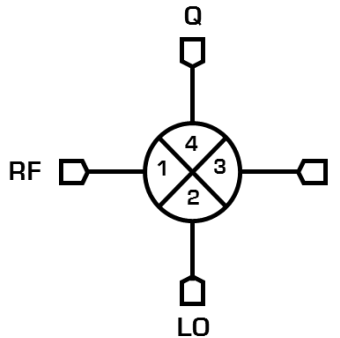

### 1.5 Part Ordering Options<sup>1</sup>

Part Number	Description	Package	Green Status	Product Lifecycle	Export Classification
MMIQ-1040SCH-2	Wire bondable die	CH	RoHS	Active	EAR99
MMIQ-1040SS	Connectorized module, die wire bonded onto PCB	S	RoHS	Active	EAR99

<sup>1</sup> Refer to our [website](#) for a list of definitions for terminology presented in this table.

## Table of Contents

1. Device Overview .....	1	4. Application Information .....	15
1.1 General Description .....	1	4.1 Detailed Description .....	15
1.2 Electrical Summary .....	1	4.2 Down-Converter .....	16
1.3 Applications .....	1	4.3 Up-Converter .....	18
1.4 Functional Block Diagram .....	1	4.4 Band Shifter .....	19
1.5 Part Ordering Options .....	1	4.5 Vector Modulator .....	20
2. Port Configurations and Functions .....	3	5. Die Mounting Recommendations .....	21
2.1 Port Diagram .....	3	5.1 Mounting and Bonding	
2.2 Port Functions .....	3	Recommendations .....	21
3. Specifications .....	4	5.2 Handling Precautions .....	21
3.1 Absolute Maximum Ratings .....	4	5.3 Bonding Diagram .....	22
3.2 Package Information .....	4	6. Mechanical Data .....	23
3.3 Recommended Operating Conditions .....	4	6.1 CH Package Outline Drawing .....	23
3.4 Sequencing Requirements .....	4	6.2 S Package Outline Drawing .....	23
3.5 Electrical Specifications .....	5		
3.6 Typical Performance Plots .....	6		

### Revision History

Revision Code	Revision Date	Comment
-	November 2019	Datasheet Initial Release

## 2. Port Configurations and Functions

### 2.1 Port Diagram

A top-down view of the MMIQ-1040S's CH package outline drawing is shown below. The mixer may be operated as either a downconverter or an upconverter. Use of the RF or IF as the input or output port will depend on the application. See Application Information for input and output port configuration for common applications.

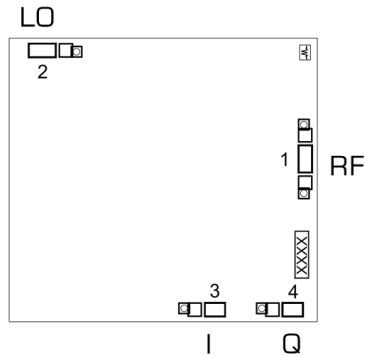

### 2.2 Port Functions

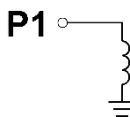
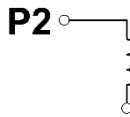
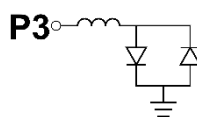
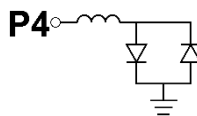
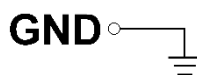
Port	Function	Description	Equivalent Circuit
Port 1	RF Input/Output	Port 1 is DC short and AC matched to 50Ω over the specified RF frequency range.	
Port 2	LO Input	Port 2 is DC open and AC matched to 50Ω over the specified LO frequency range.	
Port 3	I Input / Output	Port 3 is diode coupled and AC matched to 50Ω over the specified I port frequency range.	
Port 4	Q Input / Output	Port 4 is diode coupled and AC matched to 50Ω over the specified Q port frequency range.	
GND	Ground	CH package ground path is provided through the substrate and ground bond pads. S package ground provided through metal housing and outer coax conductor.	

### 3. Specifications

#### 3.1 Absolute Maximum Ratings

The Absolute Maximum Ratings indicate limits beyond which damage may occur to the device. If these limits are exceeded, the device may be inoperable or have a reduced lifetime.

Parameter	Maximum Rating	Units
DC Current, at any Ports	30	mA
Power Handling, at any Port	+27	dBm
Operating Temperature	-55 to +100	°C
Storage Temperature	-65 to +125	°C

#### 3.2 Package Information

Parameter	Details	Rating
ESD	Human Body Model (HBM), per MIL-STD-750, Method 1020	Class 1A
Weight	S Package	14 g

#### 3.3 Recommended Operating Conditions

The Recommended Operating Conditions indicate the limits, inside which the device should be operated, to guarantee the performance given in Electrical Specifications. Operating outside these limits may not necessarily cause damage to the device, but the performance may degrade outside the limits of the electrical specifications. For limits, above which damage may occur, see Absolute Maximum Ratings.

	Min	Nominal	Max	Units
T <sub>A</sub> , Ambient Temperature	-55	+25	+100	°C
LO drive power	+18	+20	+25	dBm
RF/IF input power			+16	dBm

#### 3.4 Sequencing Requirements

There is no requirement to apply power to the ports in a specific order. However, it is recommended to provide a 50Ω termination to each port before applying power. This is a passive diode mixer that requires no DC bias.

### 3.5 Electrical Specifications

The electrical specifications apply at  $T_A=+25^{\circ}\text{C}$  in a  $50\Omega$  system. Typical data shown is for a down conversion application with a  $+20\text{dBm}$  sine wave LO input.

Min and Max limits apply only to our connectorized units and are guaranteed at  $T_A=+25^{\circ}\text{C}$ . All bare die are 100% DC tested and visually inspected.

Parameter		Test Conditions	Min	Typical	Max	Units
RF (Port 1) Frequency Range			10		40	GHz
LO (Port 2) Frequency Range			10		40	
I (Port 3) Frequency Range			0		12	
Q (Port 4) Frequency Range			0		12	
Conversion Loss (CL) <sup>2</sup>		RF/LO = 10 - 38 GHz I = DC - 0.2 GHz		12	15	dB
		RF/LO = 38 - 40 GHz I = DC - 0.2 GHz		12.5	16	
		RF/LO = 10 - 40 GHz I = 0.2- 12 GHz		12		
		RF/LO = 10 - 38 GHz Q = DC - 0.2 GHz		12	15	
		RF/LO = 38 - 40 GHz Q = DC - 0.2 GHz		13	17	
Noise Figure (NF) <sup>3</sup>		RF/LO = 10 - 40 GHz I = DC - 0.2 GHz		12		dB
		RF/LO = 10 - 40 GHz Q = DC - 0.2 GHz		12		
Image Rejection (IR) <sup>4</sup>		RF/LO = 10 - 25 GHz I+Q = DC - 0.2 GHz		25		dBc
Amplitude Balance				0.1		dB
Phase Balance				5		°
Isolation	LO to RF	RF/LO = 10 - 40 GHz		44		dB
	LO to IF	IF/LO = 10 - 40 GHz		49		
	RF to IF	RF/IF = 10 - 40 GHz		41		
Input IP3 (IIP3) <sup>5</sup>	I+Q	RF/LO = 10 - 40 GHz I = DC - 0.2 GHz		27		dBm
Input 1 dB Gain Compression Point (P1dB)	I			16		dBm
	Q			17		

<sup>2</sup> Measured as an I/Q down converter. (i.e., I and Q powers are not combined)

<sup>3</sup> Mixer Noise Figure typically measures within 0.5 dB of conversion loss for IF frequencies greater than 5 MHz.

<sup>4</sup> Image Rejection and Single sideband performance plots are defined by the upper sideband (USB) or lower sideband (LSB) with respect to the LO signal. Plots are defined by which sideband is selected by the external IF quadrature hybrid.

<sup>5</sup> Typical IIP3 is measured with I and Q ports combined with an external IF quadrature hybrid coupler.

### 3.6 Typical Performance Plots

The test conditions and frequency plan below apply to all following sections, unless otherwise specified.

Parameter		Port	Start	Nominal	Stop	Units
RF Input Frequency		1	5		45	GHz
RF Input Power				-10		dBm
LO Input Frequency		2	5.091		45.091	GHz
LO Input Power				+20		dBm
IF Output Frequency	I	3		91		MHz
	Q	4		91		
	I+Q <sup>6</sup>	3+4		91		
T <sub>A</sub> , Ambient Temperature				+25		°C
Z <sub>0</sub> , System Impedance				50		Ω

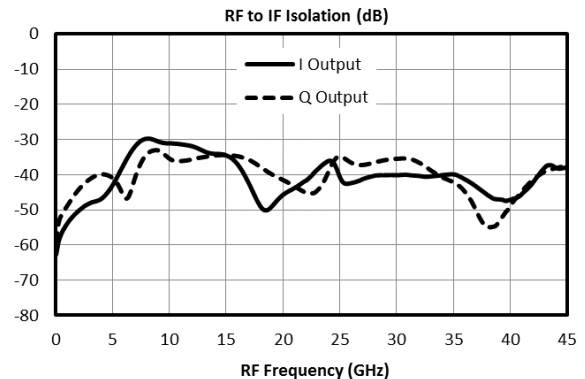
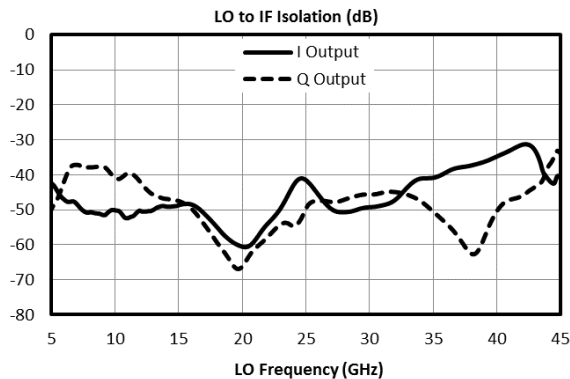
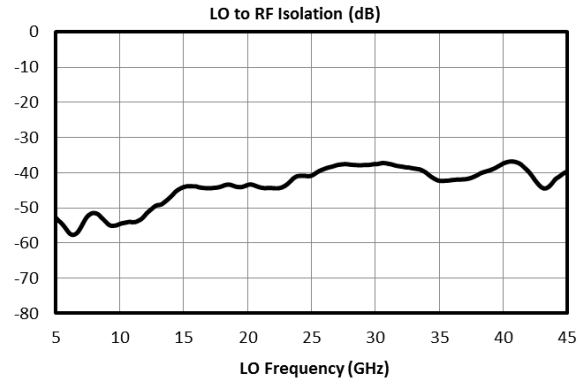
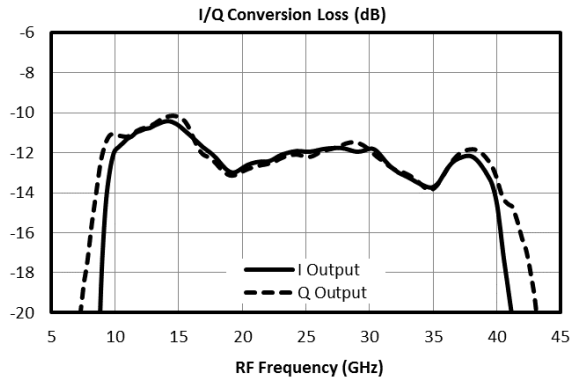

<sup>6</sup> I+Q measurements taken with an external quadrature hybrid attached to the I and Q ports of the mixer. Orientation depends on up conversion or down conversion measurement.

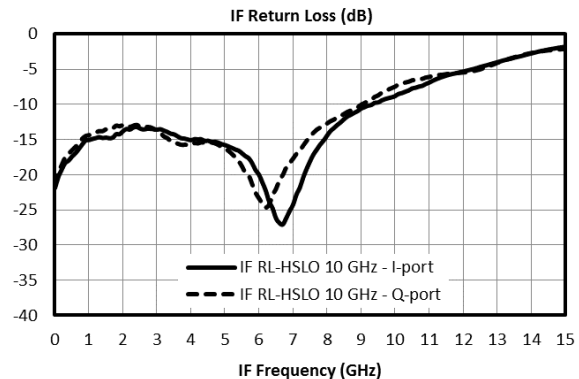
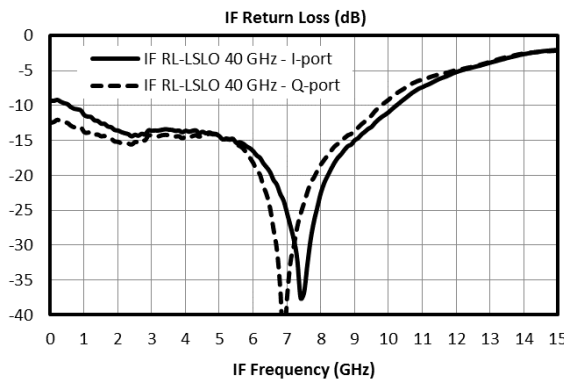
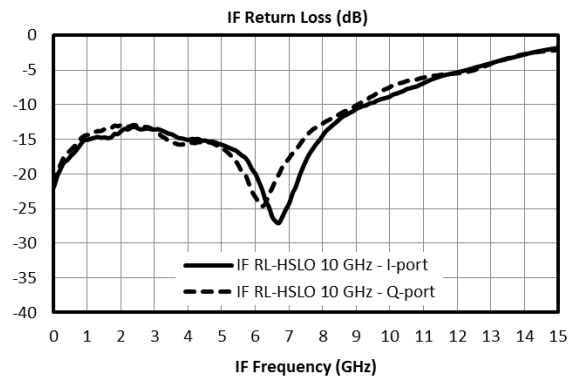
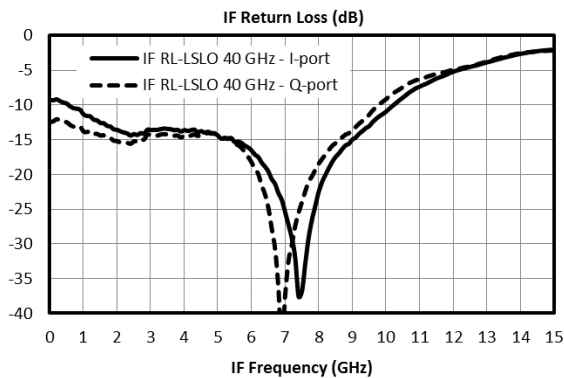
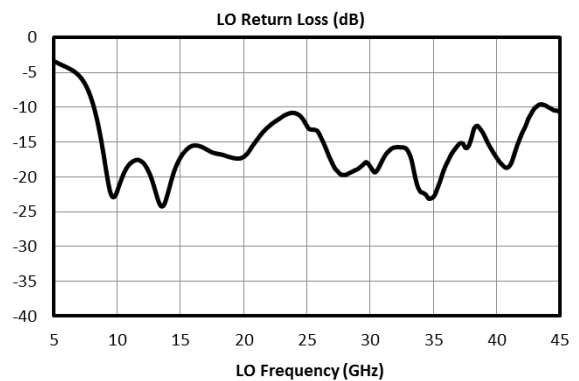
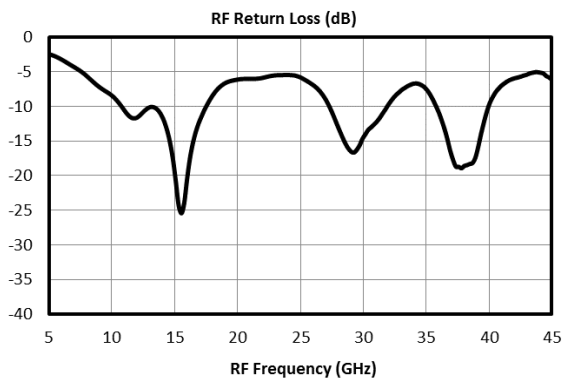
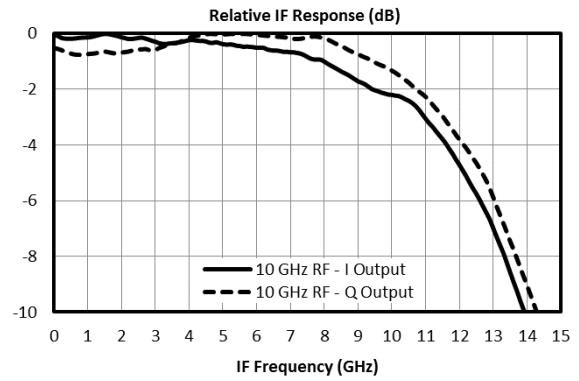
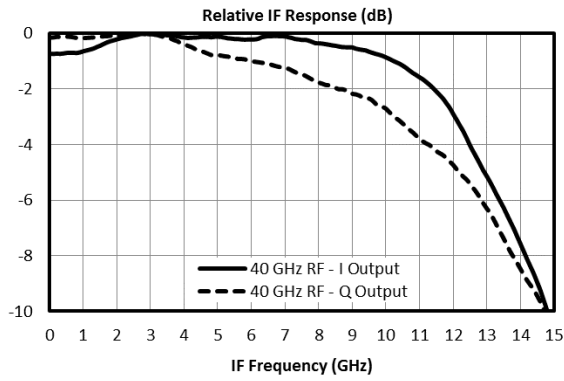

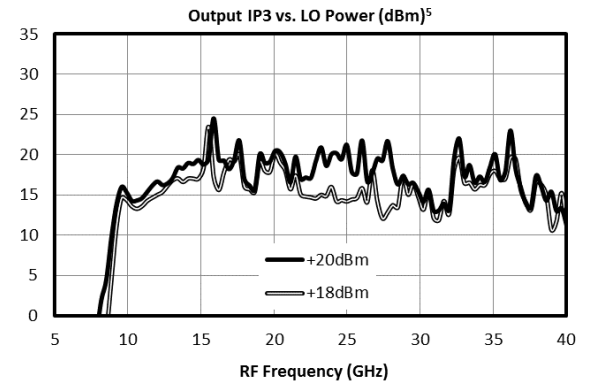
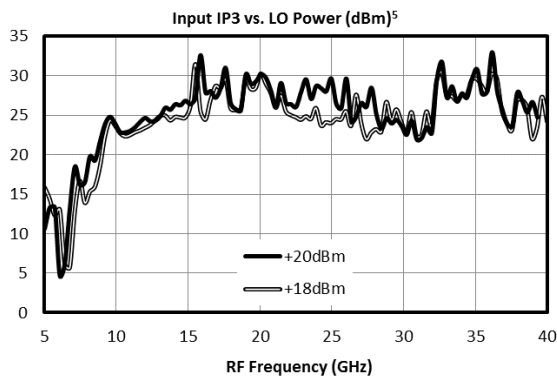
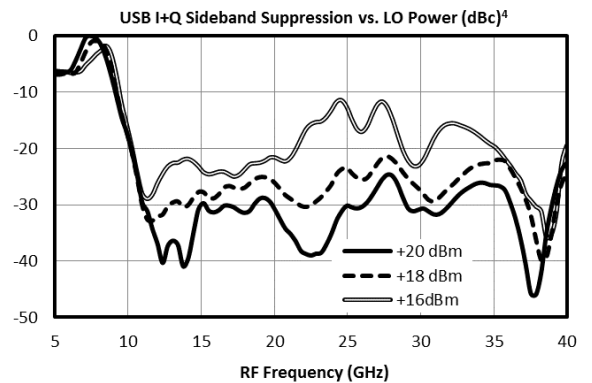
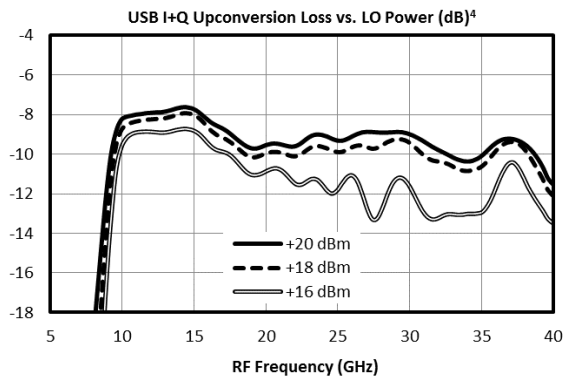
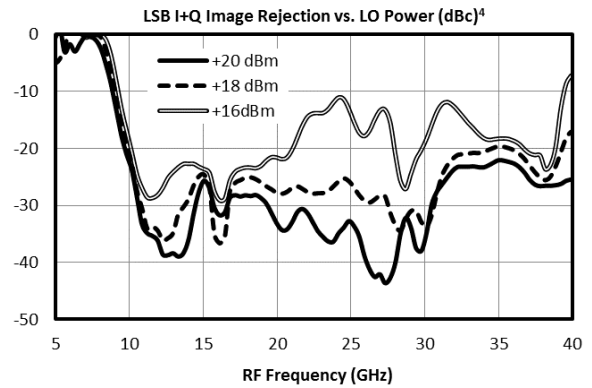
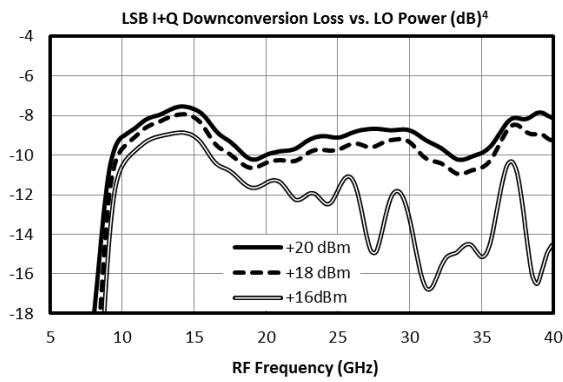
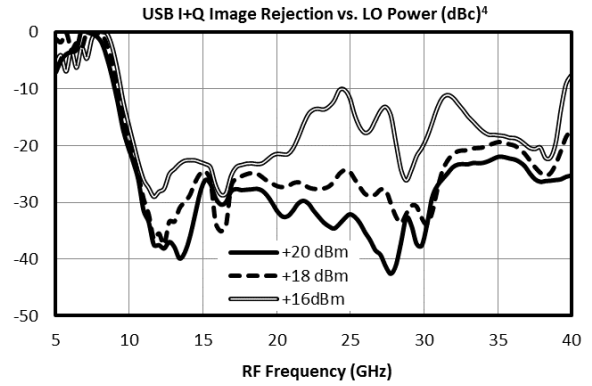
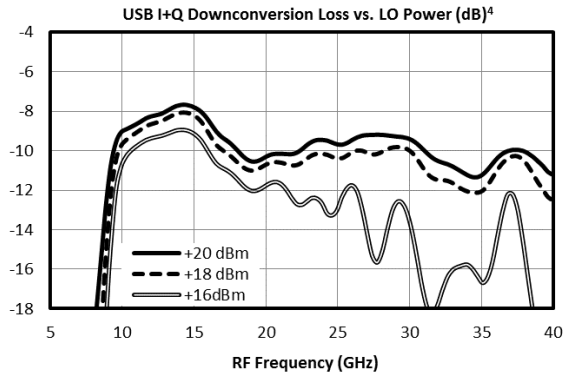



### 3.6.1 Typical Performance Plots: LO Harmonics Isolation

LO harmonic isolation plots taken with the following test conditions and based on the following fundamental input signal frequency plan:

Parameter		Port	Start	Nominal	Stop	Units
RF Input Frequency		1	5		45	GHz
RF Input Power						
		2				
LO Input Frequency						
LO Input Power				+20		dBm
IF Output Frequency	I	3		91		MHz
	Q	4		91		
T <sub>A</sub> , Ambient Temperature				+25		°C
Z <sub>0</sub> , System Impedance				50		Ω

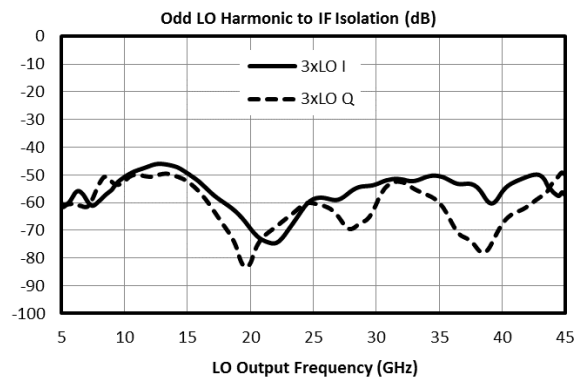
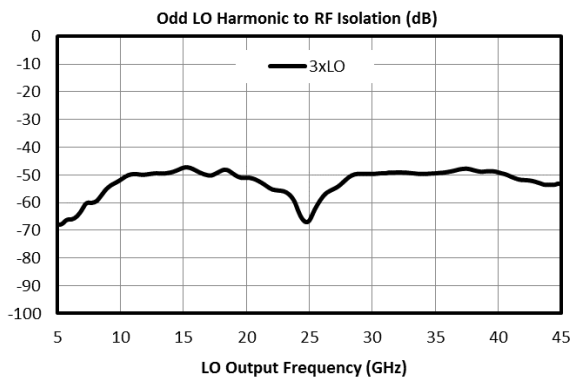
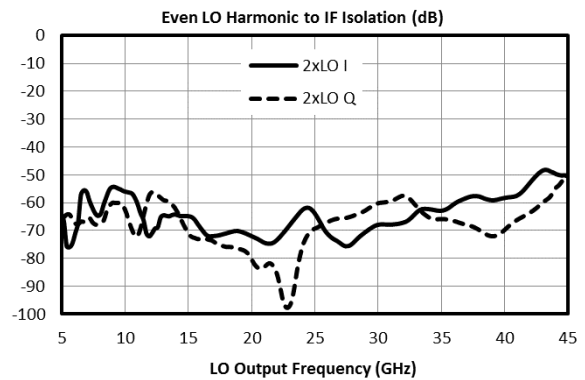
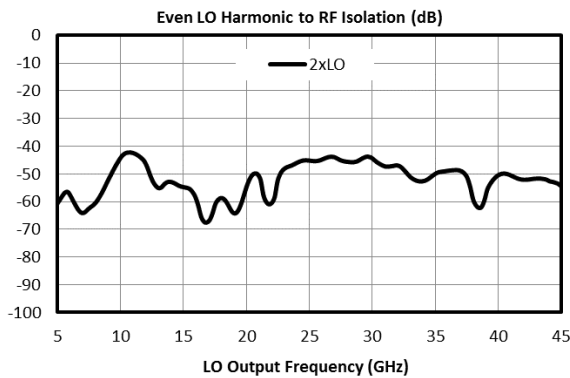

### 3.6.2 Typical Performance Plots: Band Shifter<sup>7</sup>

Band Shifter performance plots are taken with the following test conditions and frequency plan:

Parameter	Port	Start	Nominal	Stop	Units
IF Input Frequency	2		See Plot		GHz
IF Input Power	2		-10		dBm
LO Input Frequency <sup>8</sup>	3+4	0.7		15	GHz
LO Input Power	3+4		+9		dBm
RF Output Frequency	1	IF+0.7		IF+15	GHz
T <sub>A</sub> , Ambient Temperature			+25		°C
Z <sub>0</sub> , System Impedance			50		Ω

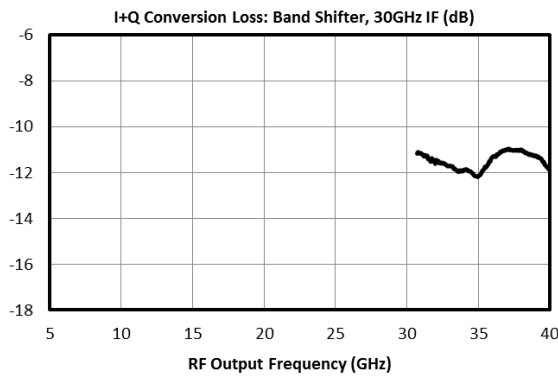
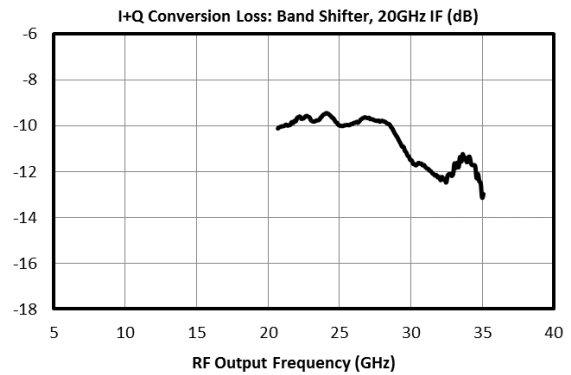
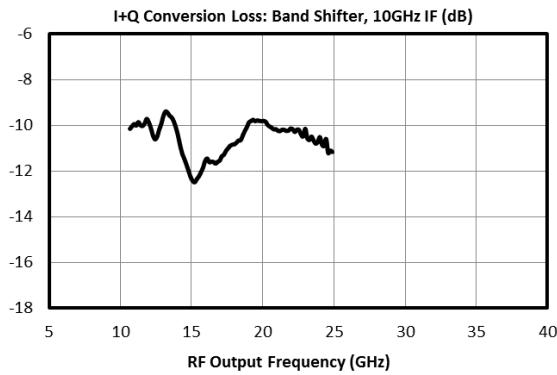

<sup>7</sup> Band shifter utilizes the mixer in a unique configuration with a low frequency LO signal. Refer to the Application Information section for more details.

<sup>8</sup> Low frequency LO quadrature hybrid used to take data is the [QH-OR714](#).

### 3.6.3 Typical Performance Plots: Vector Modulator

Vector Modulator performance plots are taken with the following test conditions and frequency plan:

Parameter	Port	Start	Nominal	Stop	Units
Input Frequency	2	5		45	GHz
Input Power			-10		dBm
I/Q Input Current	I	3	+18		mA
	Q	4	+18		
Output Frequency	1	5		45	GHz
T <sub>A</sub> , Ambient Temperature			+25		°C
Z <sub>0</sub> , System Impedance			50		Ω

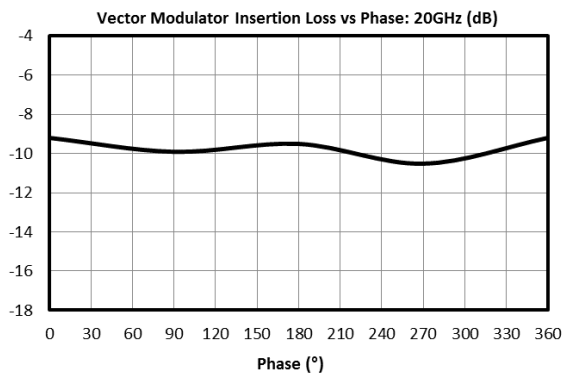
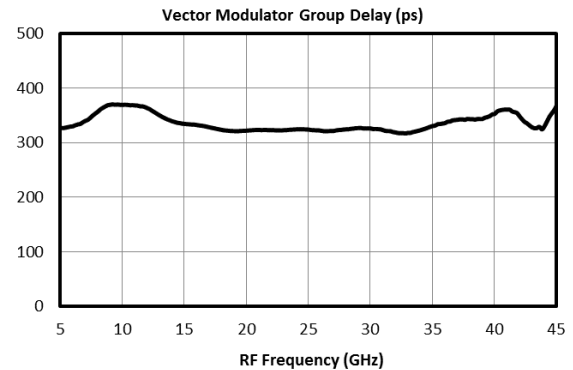
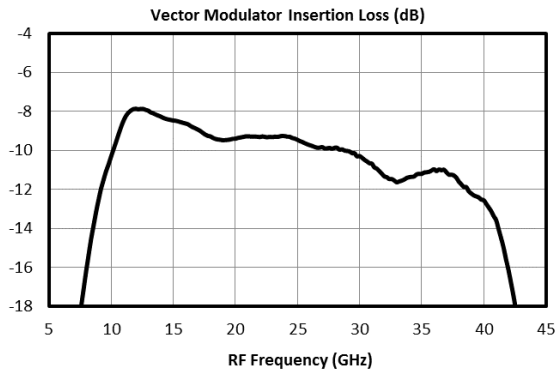

### 3.6.4 Typical Performance Plots: Downconversion Spurious Suppression<sup>9</sup>

Typical spurious data is provided by selecting RF and LO frequencies ( $\pm m \cdot \text{LO} \pm n \cdot \text{RF}$ ) within the RF/LO bands, to create a spurious output within the IF band. The mixer is swept across the full spurious band. The data shown in the graphs below are for a -10 dBm RF input. Spurious suppression is scaled for different RF power levels by  $(n-1)$ , where “n” is the RF spur order. For example, the 2LO x 2RF spur is 70 dBc for a -10 dBm input, so a -20 dBm RF input creates a spur that is  $(2-1) \times (-10 \text{ dB})$  lower, or 80 dBc. Data is shown for the frequency plan in 3.6 Typical Performance unless otherwise stated.

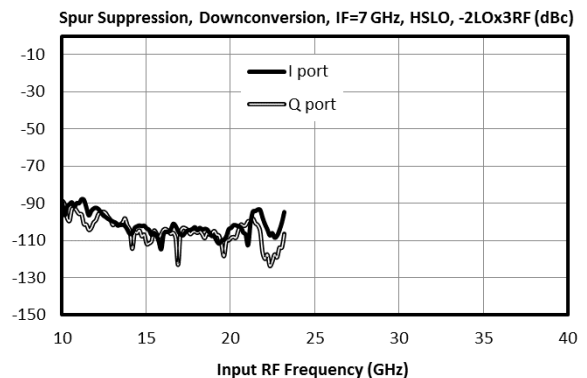
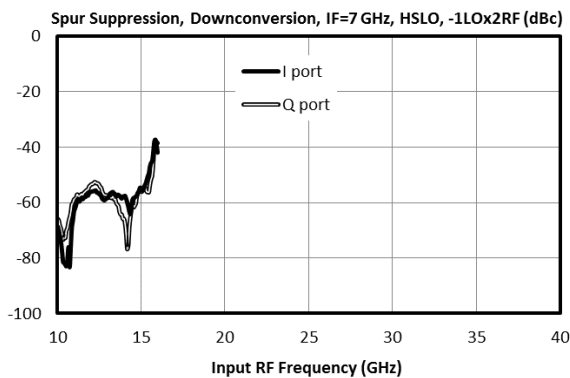
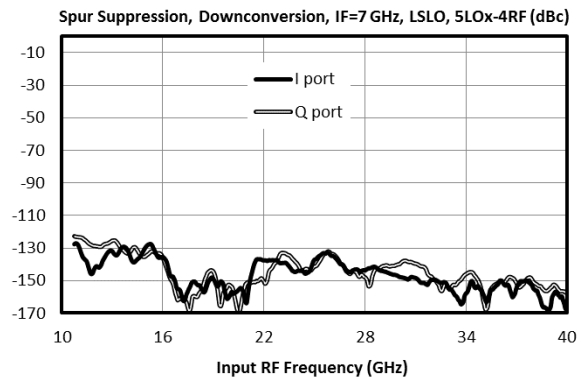
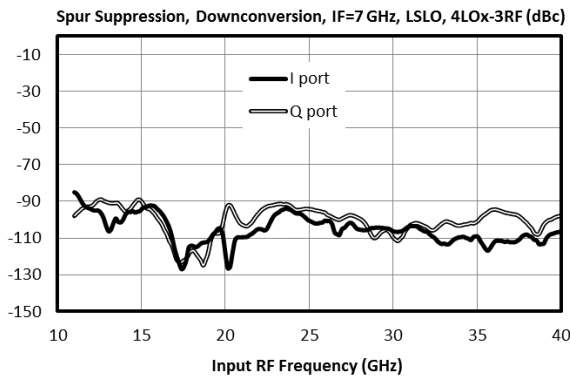
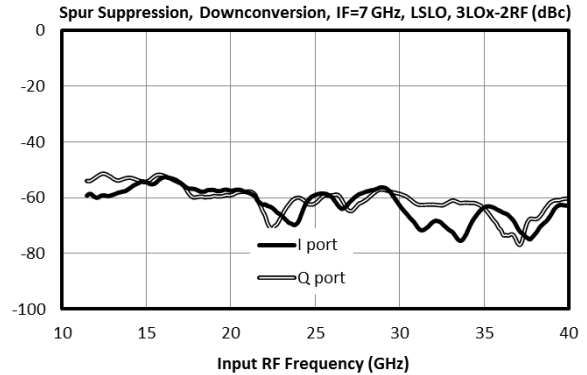
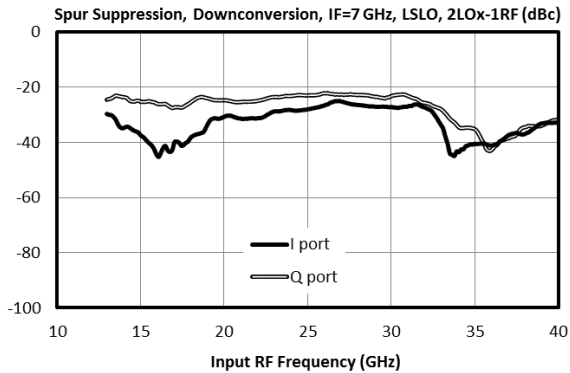

<sup>9</sup> Measured as an I/Q mixer (not IR/SSB mixer). SSB/IR mixers experience additional spurious suppressions.

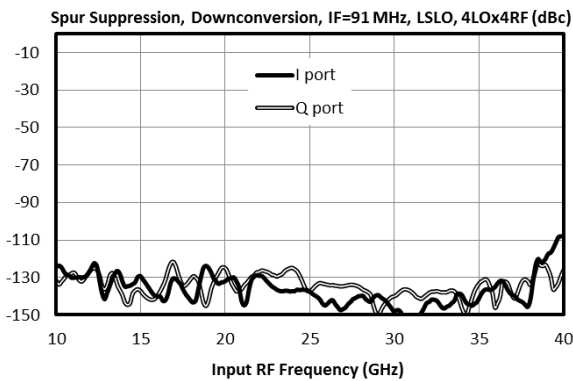
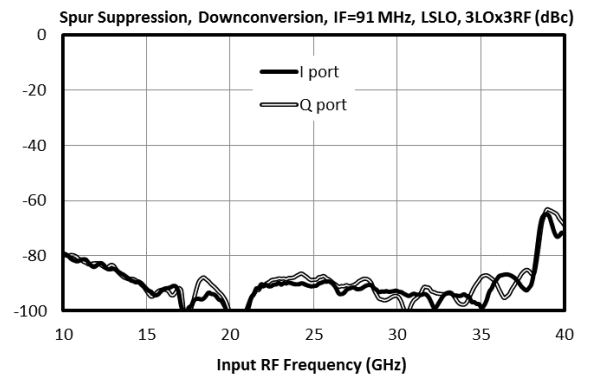
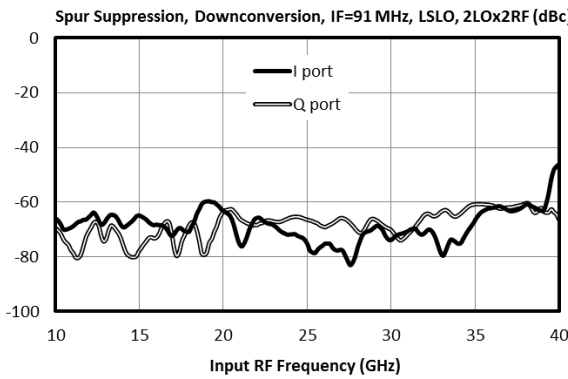
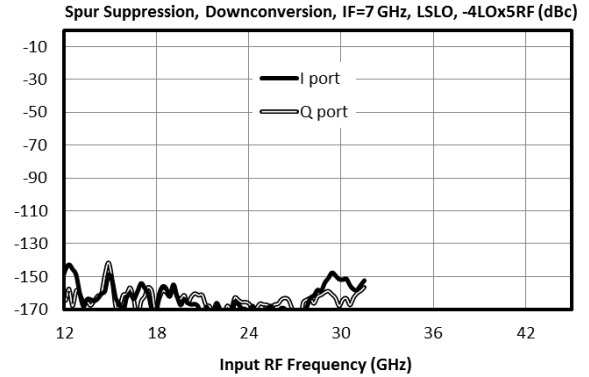
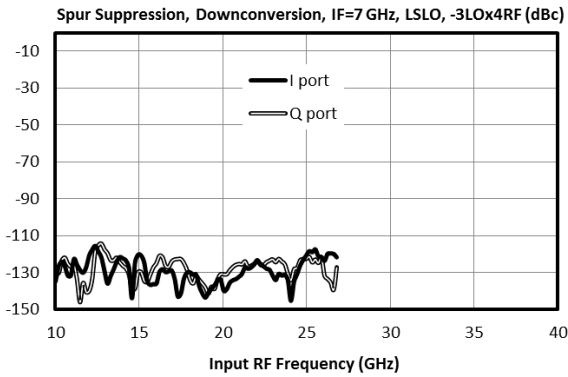

### 3.6.5 Typical Performance Plots: Upconversion Spurious Suppression<sup>10</sup>

Typical spurious data is provided by selecting IF and LO frequencies ( $\pm m \cdot \text{LO} \pm n \cdot \text{RF}$ ) within the IF/LO bands, to create a spurious output within the RF band. The mixer is swept across the full spurious band. The data shown in the graphs below are for a -10 dBm IF input. Spurious suppression is scaled for different IF power levels by  $(n-1)$ , where “n” is the RF spur order. For example, the 1LO x 2IF spur is 73 dBc for a -10 dBm input, so a -20 dBm IF input creates a spur that is  $(2-1) \times (-10 \text{ dB})$  lower, or 83 dBc. Data is shown for the frequency plan in 3.6 Typical Performance unless otherwise stated.

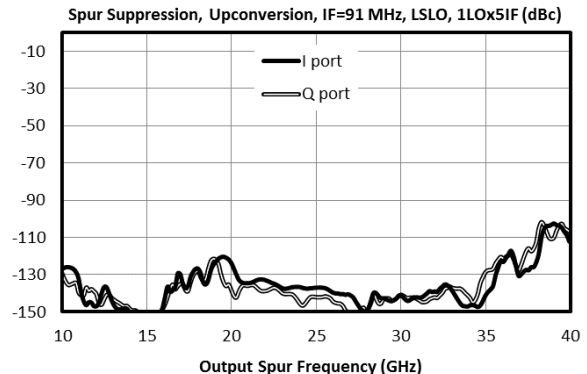
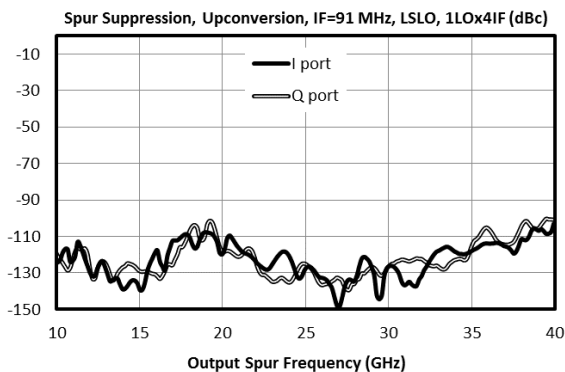
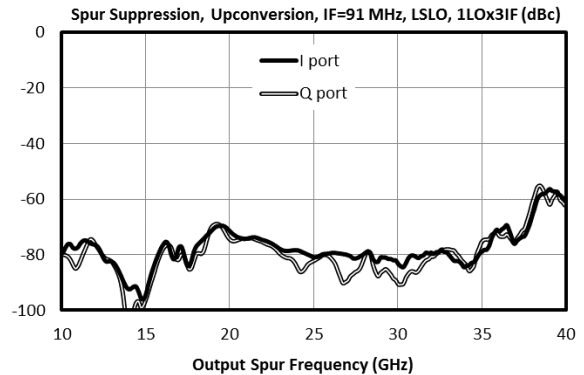
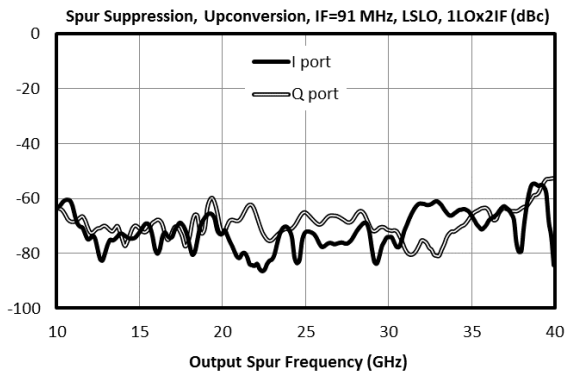

<sup>10</sup> Measured as an I/Q mixer (not IR/SSB mixer). SSB/IR mixers experience additional spurious suppressions.

## 4. Application Information

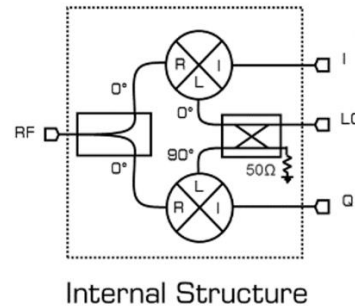
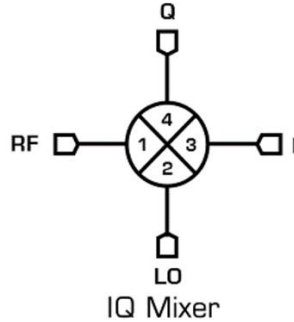

### 4.1 Detailed Description

MMIQ-1040S belongs to Marki Microwave's MMIQ family of mixers. The MMIQ product line consists of passive GaAs MMIC mixers designed and fabricated with GaAs Schottky diodes. MMIQ mixers offer excellent amplitude and phase balance due to its on-chip LO quadrature hybrid. Up to 30 dB of image rejection (i.e., single sideband suppression) can be obtained by using the MMIQ-1040 as an image rejection or single sideband mixer. The MMIQ-1037H and MMIQ-1040L are the sister mixers of the MMIQ-1040S. The MMIQ-1040S requires a higher LO drive to operate the mixer. In exchange, the MMIQ-1040S displays higher linearity (i.e., higher IIP3, P1dB, Spurious Suppression) than the MMIQ-1040L or MMIQ-1037H. Marki S, H, and L diodes correspond to different diode forward turn on voltages.

Band support for the low frequency 5G frequencies in K and Ka bands is offered by the ultra-broadband performance of the mixer's RF and LO ports (ports 1 and 2). Direct baseband to Ka band frequency conversions are available by using of this mixer as an up-converter. Traditional use of this mixer to do image reject or single sideband mixing is available with an external IF quadrature hybrid. The MMIQ-1040 is also suitable for use as a Vector Modulator through DC bias of the I and Q ports (ports 3 and 4).

Port 1, the RF port, and port 2, the LO port, supports a 10-40 GHz signal. Ports 3 and 4, the I and Q ports, support a DC-12 GHz signal. A signal may be input into any port of the mixer which supports that signal's frequency. This is the basis of using the mixer as a band shifter.

For a given LO power within the recommended operating range, the RF (in the case of a down conversion) or IF (in the case of an up conversion) input power should be below the input 1 dB compression point to avoid signal distortion. The input 1 dB compression point will vary across the mixer's operating bandwidth and with LO input power. Careful characterization is required for optimal performance for each application. There is no minimum small signal input power required for operation. Excessive RF/IF input power increases non-desired spurious output power and degrades the fundamental conversion loss. Excessive LO input power can also cause this effect.

## 4.2 Down-Converter

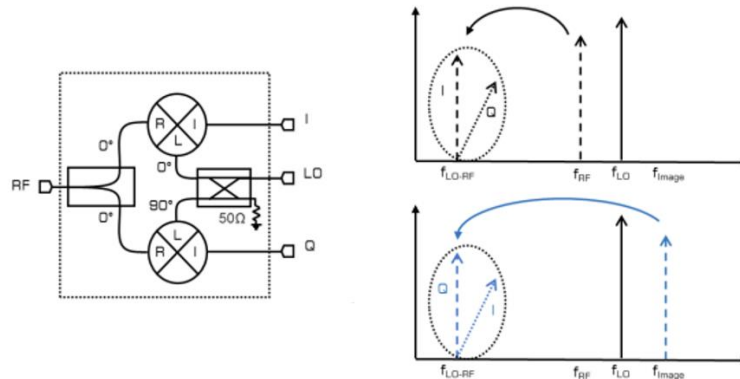

A down converter is a mixer application which takes a high frequency small signal RF input, and a high frequency large signal LO input and mixes the signals together to produce a low frequency IF output. The fundamental  $1RF \times 1LO$  outputs present at the IF port are the  $f_{LO-RF}$  and  $f_{LO+RF}$  tones. The desired output in a down conversion is typically the  $f_{LO-RF}$  term. An image frequency at  $f_{Image} = f_{2LO-RF}$  will also down convert to the  $f_{LO-RF}$  frequency. The above illustration shows the relative location of the image frequency for a highside LO, or the frequency plan for which  $f_{LO} > f_{RF}$ .

To use the IQ mixer as a down converter, input a high frequency small signal RF input into port 1, a high frequency large signal LO input into port 2, and pull the low frequency IF output from ports 3 and 4. Ports 3 and 4 will output the IF signals I and Q. I and Q IF outputs will be at the same frequency but  $90^\circ$  out of phase (i.e., I and Q are in quadrature). If only a single IF output is desired, terminate either the I or Q ports with a wideband  $50\Omega$  load.

This is the input scheme was used to take I/Q down-conversion data found in the Typical Performance Plots section.



#### 4.2.1 Image Reject Down-Converter

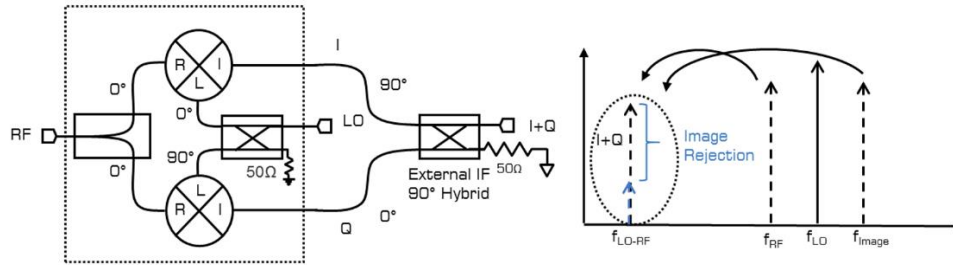

An image reject mixer is a mixer which rejects the down converted image frequency from the IF output. Image reject mixers are constructed using an external quadrature hybrid attached to the I and Q (i.e., IF) output ports of an IQ mixer. Using the external IF quadrature hybrid, one can select whether the upper sideband or lower sideband signal is suppressed with respect to the LO signal.

To use the IQ mixer as an image reject mixer, input the high frequency small signal RF into port 1 and a high frequency large signal LO input into port 2. Take the combined I+Q down converted signal through the IF quadrature hybrid. Select the upper sideband (i.e., suppress the lower sideband) by connecting the I port to the 0° port of the IF quadrature hybrid and attach the Q port to the 90° port of the IF quadrature hybrid. Select the lower sideband (i.e., suppress the upper sideband) by attaching the I port to the 90° port of the IF quadrature hybrid and attach the Q port to the 0° port of the IF quadrature hybrid.

This is the input scheme was used to take image rejection down-conversion data found in the Typical Performance Plots section.

### 4.3 Up-Converter

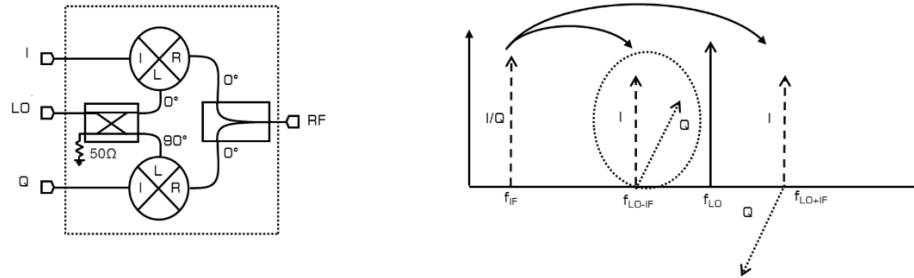

An up converter is a mixer application which takes a low frequency small signal IF input, and a high frequency large signal LO input and mixes the signal together to produce a high frequency RF output. The fundamental  $1f \times 1f_{LO}$  outputs present at the RF port are the  $f_{LO-IF}$  and  $f_{LO+RF}$  tones. An up conversion can select either the  $f_{LO-IF}$  or the  $f_{LO+IF}$  tones. The above illustration shows both up converted sidebands with either an I or Q port input signal.

To use the IQ mixer as an up converter, input a low frequency small signal IF input into port 3 or 4, a high frequency large signal LO input into port 2, and pull the high frequency RF output from port 1. Input into the Q port will result in a up converted signal that is  $90^\circ$  out of phase with the up converted I port input signal. If only a single IF input is desired, terminate either the I or Q ports with a wideband  $50\Omega$  load.

This is the input scheme used to take I/Q up-conversion data found in the Typical Performance Plots section.

#### 4.3.1 Single Sideband Up-Converter

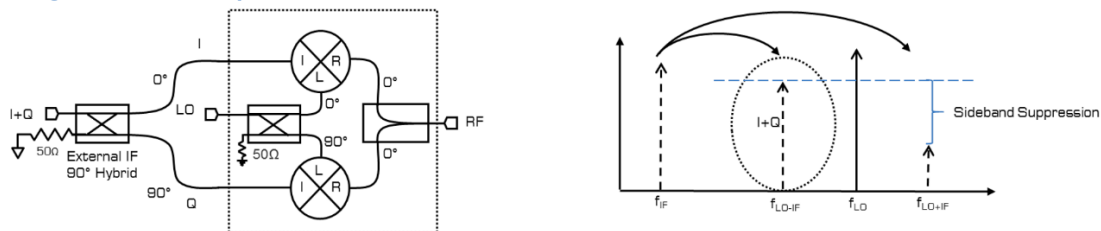

A single sideband mixer is a mixer which suppresses the up converted image frequency from the RF output. Single sideband mixers are constructed using an external quadrature hybrid attached to the I and Q (i.e., IF) input ports. Using an external IF quadrature hybrid, one can select whether the upper sideband or the lower sideband signal is suppressed with respect to the LO signal.

To use the IQ mixer as a single sideband mixer, input the low frequency small signal I+Q IF signal into the IF quadrature hybrid. The IF quadrature hybrid is attached to the I and Q ports of the IQ mixer. Input the high frequency large signal LO input into port 2 and take the up converted high frequency RF signal from port 1. Select the upper sideband (i.e., suppress the lower sideband) by attaching the I port to the  $90^\circ$  port of the IF quadrature hybrid and attach the Q port to the  $0^\circ$  port of the IF quadrature hybrid. Select the lower sideband (i.e., suppress the upper sideband) by attaching the I port to the  $0^\circ$  port of the IF quadrature hybrid and attach the Q port to the  $90^\circ$  port of the IF quadrature hybrid.

This is the input scheme used to take single sideband up-conversion data found in the Typical Performance Plots section.

## 4.4 Band Shifter

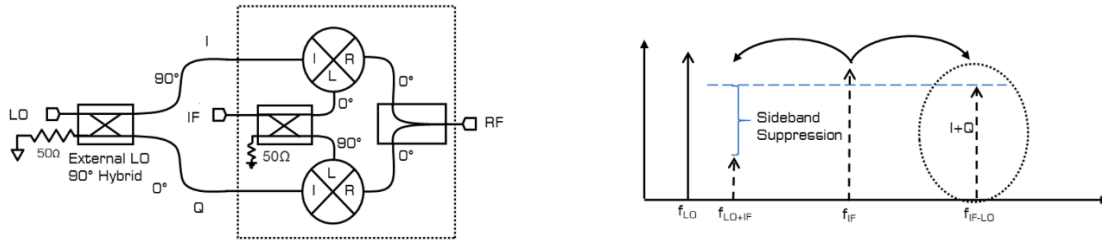

A band shifter is an unusual application for a mixer. Band shifters take an IF signal and shift it to a different band, generally to either avoid interference or for rebroadcast at a different frequency. For cases in which the desired band shift cannot be employed by using a standard up or down conversion scheme, an exotic input scheme is required.

A passive diode mixer is reciprocal on all ports. Port 1, the RF port, supports a 10-40GHz signal. Port 2, the LO port, supports a 10-40GHz signal. Ports 3 and 4, the IF ports, support a DC-12GHz signal. 2 signals input into any combination of the 3 ports, RF, LO, or IF, will result in an output signal at the 3<sup>rd</sup> port. In addition, an output signal will be present at both input ports. By using the IF port, as a large signal input port, low frequency LO applications can be supported.

The diagram above shows an IQ mixer being used as a band shifter. Using an IQ mixer as a band shifter allows for sideband suppression. This is identical to using the IQ mixer as a single sideband up converter. However, the large signal input port is now 3+4 versus port 2. Selection of the output tone is done through the orientation of the LO quadrature hybrid.

To use the mixer as a single sideband band shifter, input a low frequency large signal LO into the external LO quadrature hybrid. Input the high frequency small signal IF signal into port 2 and take the high frequency RF output from port 1. Select the upper sideband (i.e., suppress the lower sideband) by connecting the I port to the 90° port of the IF quadrature hybrid and connect the Q port to the 0° port of the LO quadrature hybrid. Select the lower sideband (i.e., suppress the upper sideband) by connecting the I port to the 0° port of the LO quadrature hybrid and connect the Q port to the 90° port of the LO quadrature hybrid.

This is the measurement scheme used to take vector modulator data found in the Typical Performance Plots: Vector Modulator section.

Using this input scheme requires careful accounting of which input signal is injecting which port. Injecting a signal into any port which does not support the correct band will lead to a degraded or no output response. Abide by the maximum DC current input into the I and Q ports of the mixer or otherwise irreversible damage to the mixer will occur.

The limitation in use of the mixer as an image reject band shifter is in the bandwidth of the external LO quadrature hybrid and bandwidth of the I and Q ports.

## 4.5 Vector Modulator

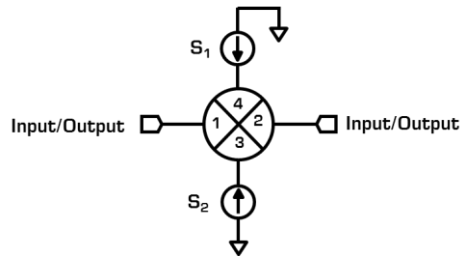

A vector modulator is a device that can modulate an input signal's amplitude and phase. Similar to using a double balanced mixer as a phase modulator or phase shifter, an IQ mixer can be used as a vector modulator. An IQ mixer can be used as a vector modulator by inputting DC current into both the I and Q ports.

Injecting DC current into both the I and Q ports forward biases both mixer cores and causes them to be shorted. This connects the RF and LO baluns allowing the input signal to pass from balun to balun without a frequency conversion. Modulating the DC current into either or both I and Q mixers causes both the phase and amplitude to modulate based on the polarity of the input current and the magnitude of the input current. Modulating only the I or Q mixers causes the device to behave as a biphaser modulator (i.e., the device can only swing the phase from  $+90^\circ$  to  $-90^\circ$ ).

To use the IQ mixer as a vector modulator, supply a DC current sufficient to turn on the mixer through both the I and Q ports. Current limiting the DC source to the maximum DC current value found in section 3.1 Absolute Maximum Ratings is recommended to prevent irreversible damage to the vector modulator. The typical DC current required to turn on the vector modulator is  $<30\text{mA}$ .

This is the input scheme used to take vector modulator data found in the Typical Performance Plots: Vector Modulation section.

It is recommended to sequence the vector modulator by slowly increasing the DC bias until the vector modulator is operating at the user desired condition.

Near the band edges of the vector modulator, more current than is typical for mid-band operation may be necessary to achieve the same amplitude and phase shift. This is due to the on chip LO quadrature hybrid operating near its band edge.

## 5. Die Mounting Recommendations

### 5.1 Mounting and Bonding Recommendations

Marki MMICs should be attached directly to a ground plane with conductive epoxy. The ground plane electrical impedance should be as low as practically possible. This will prevent resonances and permit the best possible electrical performance. Datasheet performance is only guaranteed in an environment with a low electrical impedance ground.

#### **Mounting**

To epoxy the chip, apply a minimum amount of conductive epoxy to the mounting surface so that a thin epoxy fillet is observed around the perimeter of the chip. Cure epoxy according to manufacturer instructions.

#### **Wire Bonding**

Ball or wedge bond with 0.025 mm (1 mil) diameter pure gold wire. Thermosonic wirebonding with a nominal stage temperature of 150 °C and a ball bonding force of 40 to 50 grams or wedge bonding force of 18 to 22 grams is recommended. Use the minimum level of ultrasonic energy to achieve reliable wirebonds. Wirebonds should be started on the chip and terminated on the package or substrate. All bonds should be as short as possible <0.31 mm (12 mils).

#### **Circuit Considerations**

50  $\Omega$  transmission lines should be used for all high frequency connections in and out of the chip. Wirebonds should be kept as short as possible, with multiple wirebonds recommended for higher frequency connections to reduce parasitic inductance. In circumstances where the chip more than .001" thinner than the substrate, a heat spreading spacer tab is optional to further reduce bondwire length and parasitic inductance.

### 5.2 Handling Precautions

#### **General Handling**

Chips should be handled with care using tweezers or a vacuum collet. Users should take precautions to protect chips from direct human contact that can deposit contaminants, like perspiration and skin oils on any of the chip's surfaces.

#### **Static Sensitivity**

GaAs MMIC devices are sensitive to ESD and should be handled, assembled, tested, and transported only in static protected environments.

#### **Cleaning and Storage**

Do not attempt to clean the chip with a liquid cleaning system or expose the bare chips to liquid. Once the ESD sensitive bags the chips are stored in are opened, chips should be stored in a dry nitrogen atmosphere.

### 5.3 Bonding Diagram

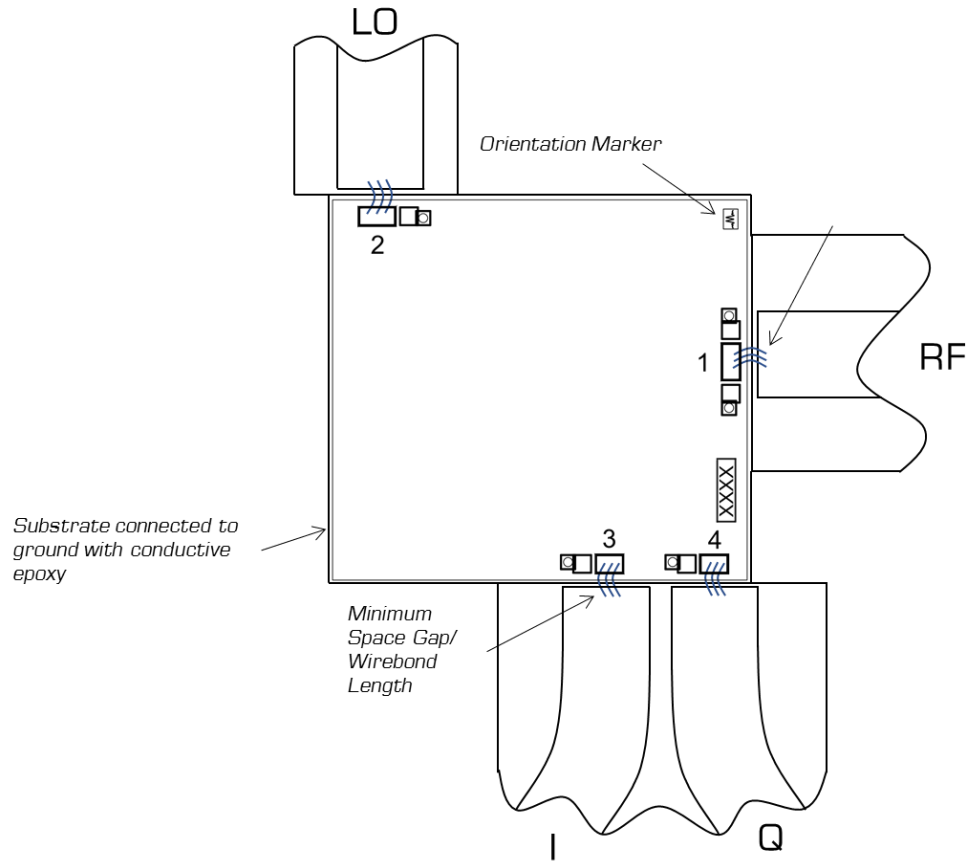

## 6. Mechanical Data

### 6.1 CH-2 Package Outline Drawing

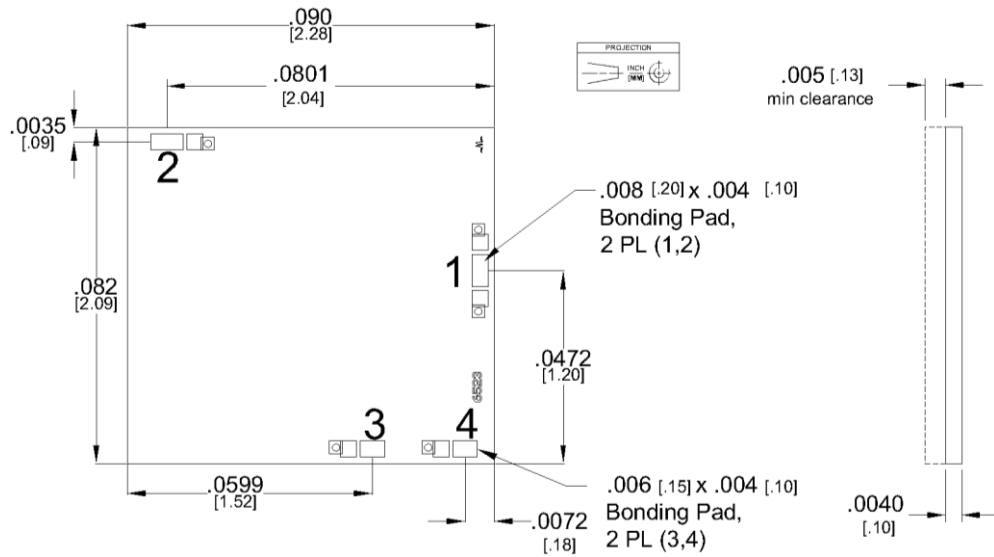

1. CH Substrate material is 0.004 in thick GaAs.
2. I/O trace finish is 4.2 microns Au. Ground plane finish is 5 microns Au.
3. XXXX denotes circuit number.

### 6.2 S Package Outline Drawing

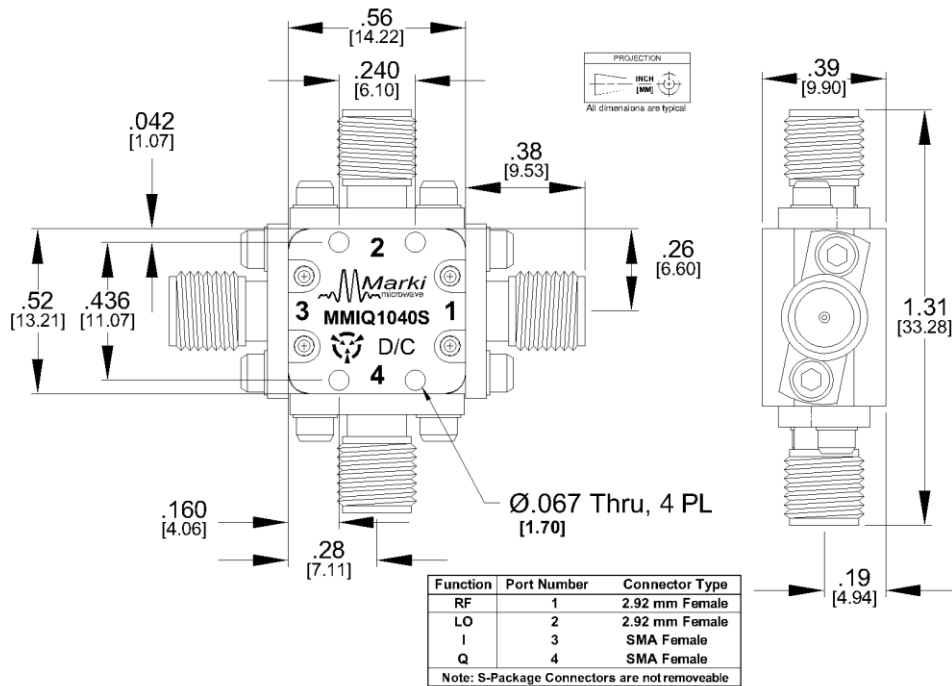

Marki Microwave reserves the right to make changes to the product(s) or information contained herein without notice.

Marki Microwave makes no warranty, representation, or guarantee regarding the suitability of its products for any particular purpose, nor does Marki Microwave assume any liability whatsoever arising out of the use or application of any product.